

# Kit 1658

**DODGE Journey**, 5-dr SUV, 12- / \*13- (Without railing)  
**FIAT Freemont**, 5-dr SUV, 12- (Without railing)

\*North America

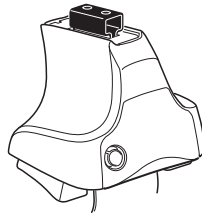

**754** Rapid System  
**480R** Rapid Traverse (North America)

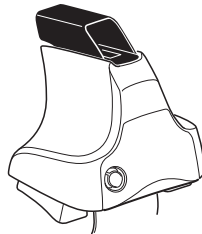
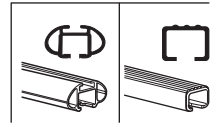

**480** Traverse (North America)

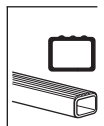

754 Rapid System  
480R Rapid Traverse (North America)

480 Traverse (North America)

1

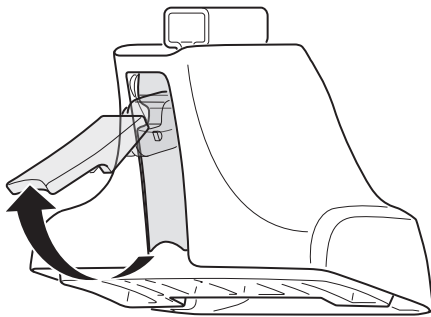

2



754 Rapid System  
480R Rapid Traverse  
(North America)

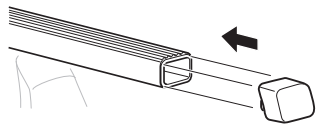
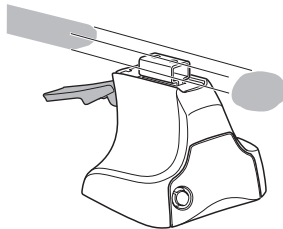

x4

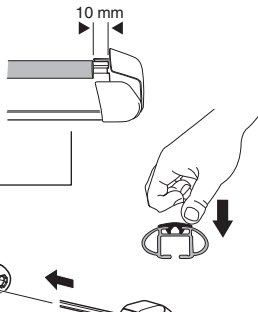

x4

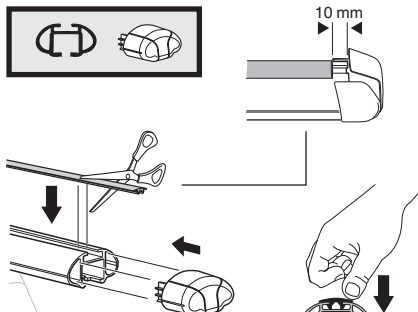

x4



480 Traverse  
(North America)

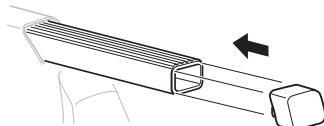
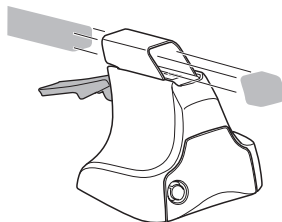

x4

**3**

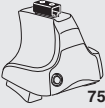

**754** Rapid System

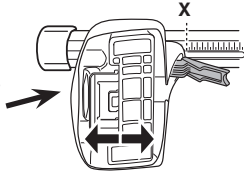

	<b>X</b>
<b>DODGE Journey, 5-dr SUV, 12- / *13- (Without railing)</b>	<b>53</b>
<b>FIAT Freemont, 5-dr SUV, 12- (Without railing)</b>	<b>53</b>

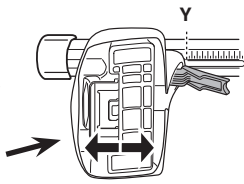

	<b>Y</b>
<b>DODGE Journey, 5-dr SUV, 12- / *13- (Without railing)</b>	<b>49,5</b>
<b>FIAT Freemont, 5-dr SUV, 12- (Without railing)</b>	<b>49,5</b>

**3**



**480R** Rapid Traverse



**480** Traverse



**(North America)**



	<b>X inch</b>	<b>X mm</b>
<b>DODGE Journey, 5-dr SUV, 12- / *13- (Without railing)</b>	<b>46 1/2"</b>	<b>1181 mm</b>
<b>FIAT Freemont, 5-dr SUV, 12- (Without railing)</b>	<b>46 1/2"</b>	<b>1181 mm</b>



	<b>Y inch</b>	<b>Y mm</b>
<b>DODGE Journey, 5-dr SUV, 12- / *13- (Without railing)</b>	<b>45 1/8"</b>	<b>1146 mm</b>
<b>FIAT Freemont, 5-dr SUV, 12- (Without railing)</b>	<b>45 1/8"</b>	<b>1146 mm</b>

**4**

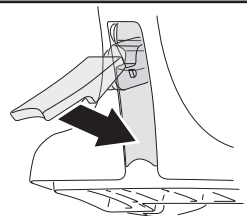

# 5

DODGE Journey, 5-dr SUV, 12- / \*13- (Without railing)

FIAT Freemont, 5-dr SUV, 12- (Without railing)

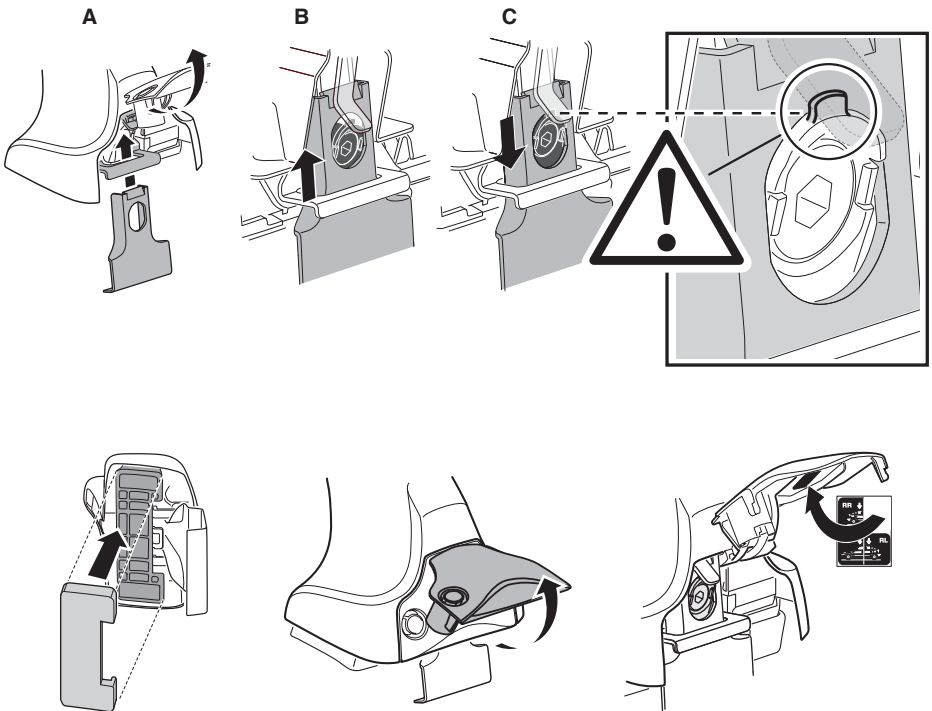
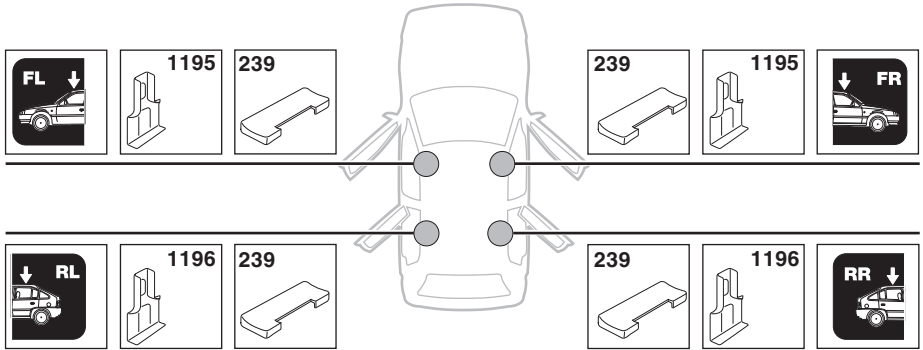

6

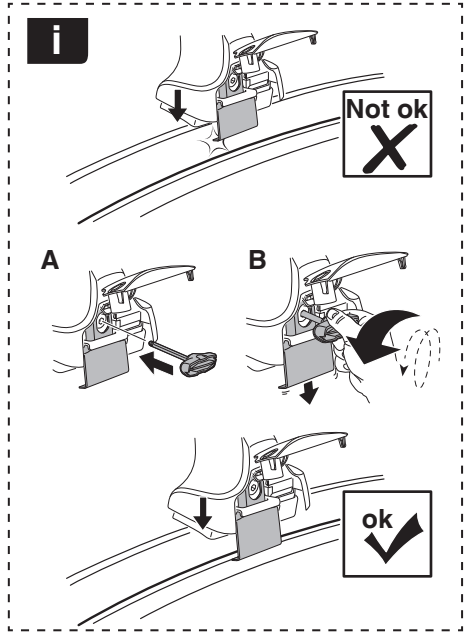
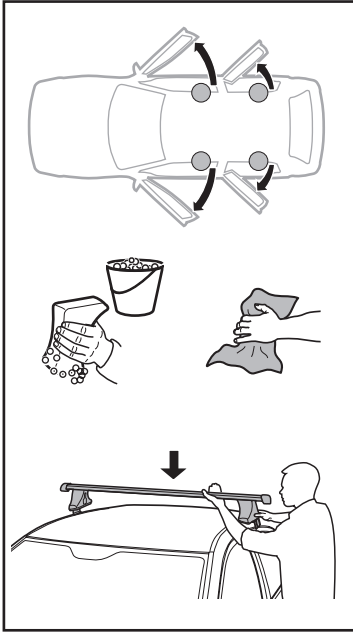

	X mm	Y mm	X inch	Y inch
<b>DODGE Journey, 5-dr SUV, 12- / *13- (Without railing)</b>	438 mm	711 mm	17 1/4"	28"
<b>FIAT Freemont, 5-dr SUV, 12- (Without railing)</b>	438 mm	711 mm	17 1/4"	28"

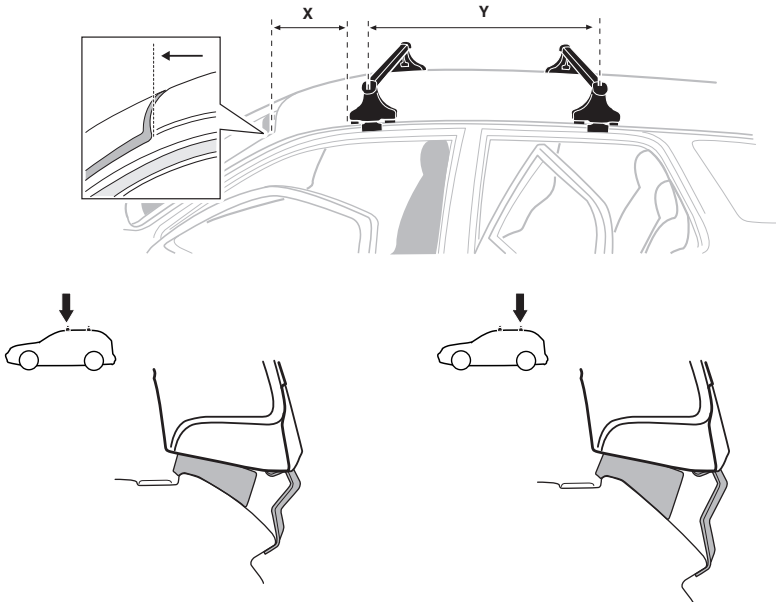

7

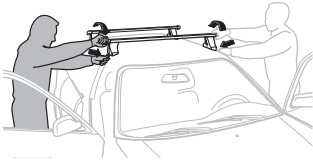

EN Tighten alternately  
 DE Die Schrauben abwechselnd anziehen  
 FR Serrer alternativement chaque côté  
 NL Afwisselend aan de linker- en de rechterkant aandraaien  
 IT Alternare il serraggio delle viti  
 ES Apretar alternativamente  
 PT Aperte alternadamente  
 SV Dra åt växelvis  
 DK Spænd skiftevis  
 NE Trekk til vekselvis  
 FI Kierrä vuorotellen  
 ET Pinguldage vaheldumisi  
 LV Pievelciēt pamišus  
 LT Užsukinėkite pakaitomis  
 PL Śruby dokręcaj naprzemiennie

RU Затягивайте попеременно  
 UK Затягти по чергово  
 BG Затегнете последователно  
 CS Pokręťta багаžníka dokręcaj dokręcaj naprzemiennie.  
 SK Dofahujte striedavo  
 SL Privijajte izmenično.  
 HR/BIH Naizmjenično zategnite  
 HU Egymástól függetlenül szorítandó  
 EL Σφίγγετε εναλλάξ  
 TR Dönüşümlü sıkın

إحكام الربط بالتناوب  
 AR חזק לסיבוב  
 HE

ZH 交替拧紧  
 JA 自動固定  
 KO 번갈아 조이기  
 TH ซลับในแบบสลับ

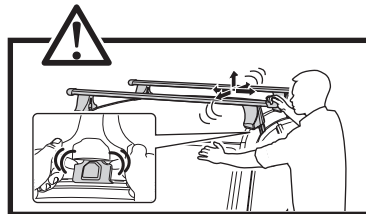
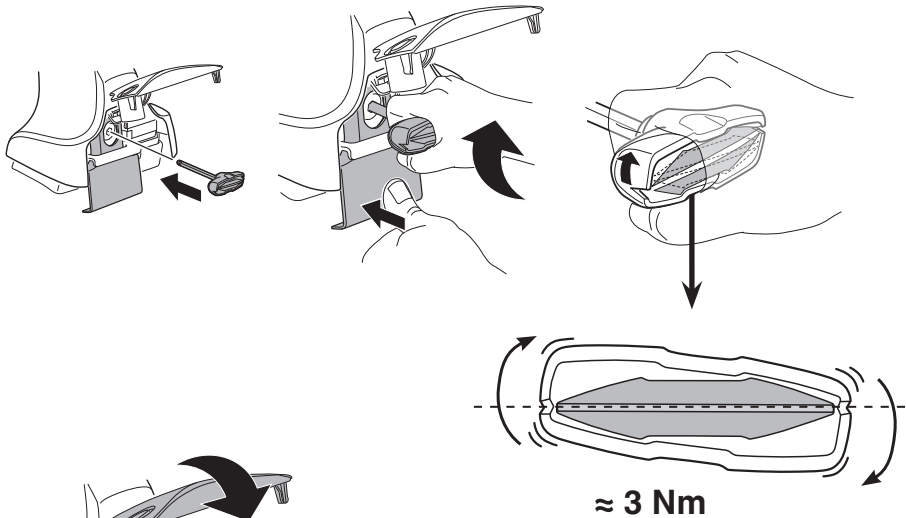

8



x1  
17 mm

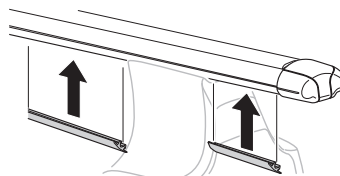
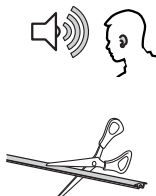

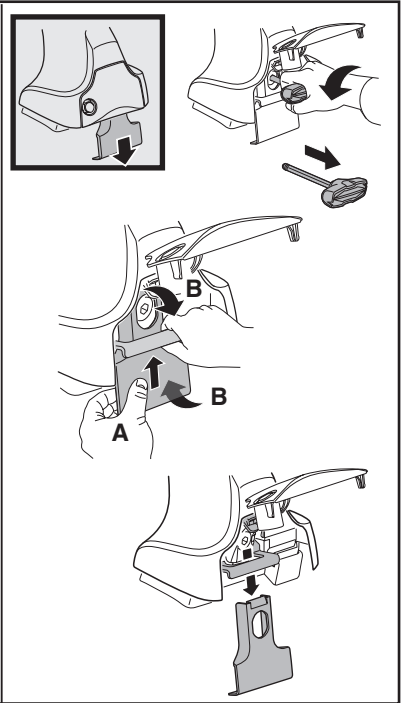
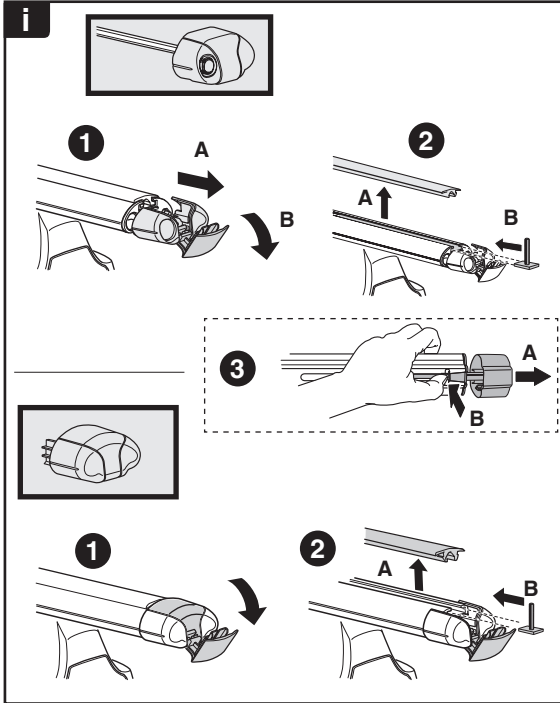
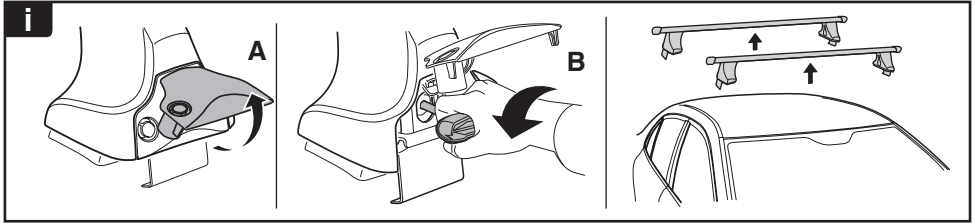

**THULE**  
SWEDEN  
**ONE  
KEY  
SYSTEM**

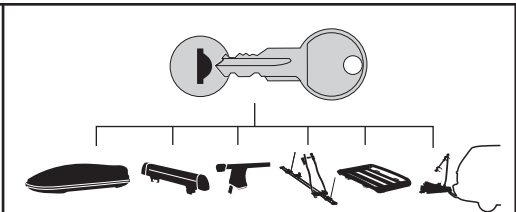

- 544** (x4)
  - 596** (x6)
  - 588** (x8)
  - 510** (x10)
  - 452** (x12)
- NA  
EUR  
ASIA

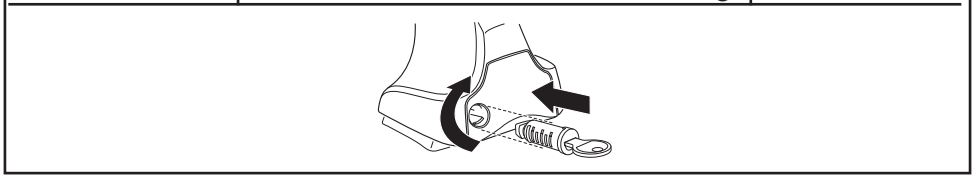

**WW** ▶ Thule Sweden AB, Box 69, 330 33 Hillerstorp, SWEDEN  
**NA** ▶ Thule Inc., 42 Silvermine Road, Seymour, Connecticut 06483, USA

**@** info@thule.com  
customer.service@thule.com

**www.thule.com**