

ACCESSORIES

FALL Data Book

ALPHABETICAL

ALL VEHICLES
2001 MODEL YEAR APPLICATIONS



THE MOPAR DIFFERENCE



ACCESSORIES

**▶▶ Data
▶▶ Book**

ALPHABETICAL

**ALL VEHICLES
2001 MODEL YEAR APPLICATIONS**



T H E M O P A R D I F F E R E N C E

ACCESSORIES ALPHABETICAL INDEX

ACCESSORY	PAGE
Add-A-Trunk	1
Air Bag Locks	2
Air Conditioning Kits	3-4
Air Conditioning, Additional Components	3-4
Air Deflectors, Front	5-6
Air Deflectors, Front, Quantity Purchase	6
Air Deflectors, Rear	7
Air Filtration, Passenger Cabin	8
Audio Products	
Antennas	9
CD Changers	10-16
Radios	17-25
Sound Bar	26
Subwoofer	27-28
Auxiliary Transmission Coolers	29
Bed Extender	30
Bed Lights & Power Outlet	31
Bedliners	32-33
Bed Mats/Bed Trays	34-35
Bed Rail Protectors	36-37
Bed Side Rails	38-39
Bed Web Net	40
Bed Web Nets, Quantity Purchase	40
Bumpers	41-43
Cargo Area Liner	44
Cargo Area Mat	45
Cargo Area Security Cover	46
Cargo Area Tray, Adjustable	47
Cargo Area Tray, Carpet	48
Cargo Area Tray, Molded	49-51
Cargo Barrier	52
Cargo Net	53-54
Cargo Organizer™ Minivan	55
Cargo Organizer Tray, for Gull Wing Tonneau Cover	242
Cellular Phone Holder	56-57
Consoles	58-59
Cooler Insert	60
Covers	
Cockpit	61
Front End	62-65
Front End, Cold Weather	65
Hood	66-67
Spare Tire, Custom Dealer Imprinted	69
Spare Tire, Deluxe Antitheft	68-69
Spare Tire, Fabric	70-71
Spare Tire, Premium Hard Cover	72
Vehicle	73-75
Diesel Engine Fan Clutches	76
Diesel Exhaust Brakes	76
Door Edge Guards	77-78
Door Entry Guards	79
Engine Block & Battery Heaters	80-81
EVS Systems	
Quick Reference	82
EVS Base Security System	83-84

ACCESSORY	PAGE
EVS II Interior Theft (ITs)	85
EVS II Security System	86
EVS II Security Plus System	87-88
EVS II Service Parts	89
EVS System, Keyless Entry	90
Floor Mats	
Carpet (OE Style)	91-95
Formed Carpet	96
Rubber	97-98
Slush Style	99-101
Garment Bags	102
Gas Cap, Locking	103
Grocery Bag Holders	104-105
Ground Effects	106
Guards — Brush/Grille	
Quick Reference	107
Brush, Jeep	108-109
Brush, Deluxe Tubular, Truck	110-111
Brush, Molded, Ram Sport Pickup	112
Grille, Jeep	113
Grille, Truck	114-115
Hitch Receivers	
Quick Reference	116-117
Hitch Ball	118-120
Hitch Receivers	121-122
Ball Mount Kits	123-124
Installation Bezels	125
Quantity Discount Purchases	125
Receiver Plugs	126
Wiring Harnesses, Brackets & Adapters	127-129
Wiring Harnesses, Trailer Towing Packages	130-131
Interior Trim Appliques	132-133
Light Bars	
Jeep	134, 136
Truck	135-136
Lights	
Fog	137-139
Miscellaneous	139
Off-road	140-142
Tail, Guard	143
Master Shield Products	144
Mirrors, Trailer Towing	145
Navigation System	146-149
Paint, Touch-Up	
Passenger Cars	150-151
Jeep	151
Minivan	152
Truck	153
Racks & Carriers	
Adapters	154
Airporter	155
Carriers	
Bicycle, Bed-Mount	156-157
Bicycle, Hitch-Mount	158-159
Bicycle, Interior-Mount	160

ACCESSORIES ALPHABETICAL INDEX (CONT.)

ACCESSORY	PAGE
Bicycle, Roof-Mount.....	161-162
Bicycle, Spare Tire-Mount.....	163
Canoe	164
Commercial Equipment, Ram Rack	165
Luggage	166
Roof Basket.....	167
Ski & Snowboard, Bed-Mount.....	168
Ski & Snowboard, Hitch-Mount.....	169
Ski & Snowboard, Roof-Mount	170-172
Ski & Snowboard, Spare Tire-Mount	173
Watersports	174
Luggage Racks	
Hitch-Mount.....	175
Roof-Mount.....	176-177
Sport-Utility Bars.....	177
Rear Seat Video™	178-179
Rock Rails	180
Running Boards	
Jeep	
Aluminum.....	181
Molded.....	182-183
Minivan	
Aluminum.....	184
Premium Molded	185-186
Truck	
Aluminum.....	187
Diamond Plate	188
Molded.....	189-193
Saddle Bag	194
Seatback Backpack.....	195
Seat Covers.....	196-198
Side Steps	
Jeep	
Molded	199
OE Style.....	200
Tubular	201-202
Truck	
Mini	203
Molded.....	204-206
Power	207
Tubular	208-209
Skid Plates	210-211
Smoker's Package	212
Snow Plows, Front Air Shock Kit	213
Spare Tire Lock Kits.....	214
Speed Control.....	215-216

ACCESSORY	PAGE
Splash Guards	
Deluxe Anti-Spray	217
Deluxe Molded	218-220
Diamond Plate.....	221
HD Rubber.....	222
Molded, Flat	223-225
Spoilers.....	226-228
Storage Products	
Lockable Box.....	229
Ski Pass-Through Bag.....	230
Storage Bag.....	231
Underseat Storage Compartment.....	232
Sunshades.....	233-234
Tailgate Protectors.....	235
Tie Downs	236
Tie Downs, Quantity Purchase	236
Tire Carrier, Roof-Mount	237
Tonneau Cover, Wrangler	238
Tonneau Covers	
Fabric, Snapless	239
Fabric, Snap-Style.....	240-241
Gull Wing Style, Fiberglass.....	242
Hard, Folding	243-244
One-piece Fiberglass	245-246
Pop-up, Soft	247
Toolboxes	248
Tops	
Hardtop	249-250
Soft Top	251-252
Soft Top Boot.....	253
Sun Bonnet (Half-Top)	254
Sun Bonnet, Tonneau & Windscreen Combination.....	255
Windscreen, Jeep.....	256
Tow Hooks	
Jeep.....	257
Truck.....	258
Trailers, Prowler	259
Ventvisor.....	260-261
Wheels, Jeep	262
Wheels, Passenger Car & Truck	263-264
Wheel Flares.....	265-266
Wheel Lock Sets.....	267-269
Wheel Trim Rings	270
Winches.....	271-273
Winch Mounting Kits.....	274
Windscreen, Convertible	275

PART NUMBER INDEX

PART NUMBER	PAGE	PART NUMBER	PAGE	PART NUMBER	PAGE	PART NUMBER	PAGE
04271236	144	82201252	142	82202313	1	82202706	182
04271237	144	82201359	173	82202317	9	82202717	219
04318045	144	82201480	163	82202338	103	82202718	219
04339343	144	82201505	81	82202339	225	82202719	219
04339344	144	82201506	81	82202341	69	82202721	67
04339345	144	82201649	268	82202351	51	82202722	74
04504840	268, 269	82201650	268, 269	82202352	51	82202723	241
04504841	268	82201692	69	82202353	51	82202727	244
04549284	124	82201771	266	82202354	51	82202733	208
04595823AA	212	82201775	142	82202355	51	82202734	208
04598533AA	212	82201776	142	82202356	51	82202735	208
04698120	54	82201777	142	82202377	252	82202736	208
04704373AE	24	82201778	142	82202378	42	82202737	208
04704376AC	24	82202045	54	82202379	256	82202738	208
04704377AE	24	82202046	64	82202388	194	82202741	115
04704380AE	24	82202047	64	82202390	194	82202752	187
047043816AD	23	82202048	67	82202391	231	82202754	6
04704383AH	21, 22	82202051	122	82202392	47	82202758	261
04704384AE	22	82202053	220	82202393	78	82202759	79
04704385AE	21	82202054	67	82202394	138	82202760	78
04704386AE	23	82202055	78	82202399	195	82202762	274
04704386AD	23	82202056	51	82202400	195	82202763	274
04720928	25	82202081	63	82202403	133	82202776	61
04787493AA	54	82202082	63	82202437	86	82202777	39
04858540AG	21, 22	82202089	128, 129	82202441	86	82202778	39
04858540AH	21	82202094	254	82202464	193	82202779	39
04858555AE	24	82202109	238	82202465	193	82202780	39
04858558AE	21	82202118	253	82202466	193	82202781	39
04858583AF	21	82202125	252	82202467	193	82202782	39
04858584AH	23	82202129	249	82202468	193	82202783	39
04858585AF	24	82202137	202	82202469	193	82202784	136
04858585AG	24	82202138	202	82202470	193	82202785	136
05003119AA	29	82202139	202	82202474	193	82202786	136
05015636AA	103	82202140	202	82202500	81	82202787	136
05016763AB	103	82202147	109	82202526	142	82202791	248
05017415AA	148, 149	82202148	109	82202529	142	82202814	6
05017416AA	148, 149	82202149	109	82202538	211	82202816	231
05017417AA	148, 149	82202150	109	82202555	202	82202817	122
05017501AA	179	82202160	6	82202559	6	82202819	65
05247022	268	82202161	6	82202562	213	82202820	231
05278655AA	103	82202173	42	82202578	220	82202821	231
0SZ19WL8AB	14	82202174	42	82202583	257, 258	82202826	213
0SZ19XDVAB	14	82202175	42	82202584	273	82202827	154
0SZ19XTMAB	14	82202186	257	82202599	98	82202851	211
0SZ19YBPAB	14	82202191	273	82202600	98	82202852	121
52100376AE	211	82202213	75	82202610	138	82202853	114
55217379	54	82202229	236	82202612	273	82202854	114
55346644AG	261	82202230	40	82202646	190	82202855	114
56019823	128, 129	82202231	40	82202649	190	82202856	111
56038518AF	22	82202232	40	82202651	190	82202857	111
56038518AH	22	82202233	40	82202654	190	82202858	111
56038567AF	22	82202234	40	82202659	190	82202864	257
56038623AF	23	82202274	224	82202661	190	82202872	264
56038931AB	21	82202275	75	82202669	190	82202874	264
56038933AB	21	82202276	61	82202671	190	82202875	264
56038937AB	21	82202283	76	82202690	211	82202877	266
82200248	124	82202292	12, 13, 14	82202691	111	82202882	266
82201148	124	82202296	261	82202692	114	82202883	266
82201149	124	82202297	79	82202693	209	82202884	266
82201228	139	82202304	222	82202700	14, 15	82202885	266
82201229	138, 139	82202305	222	82202701	182	82202890	205
82201230	138, 139	82202306	220	82202702	182	82202893	205
82201231	139	82202307	220	82202703	182	82202894	42

PART NUMBER INDEX (CONT.)

PART NUMBER	PAGE	PART NUMBER	PAGE	PART NUMBER	PAGE	PART NUMBER	PAGE
82202901.....	205	82203162.....	84	82203391.....	201	82203619.....	219
82202904.....	205	82203169.....	63	82203394.....	199	82203622.....	51
82202905.....	274	82203171.....	236	82203395.....	199	82203623.....	51
82202908.....	25	82203185.....	115	82203396.....	199	82203624.....	51
82202909.....	222	82203186.....	115	82203399.....	199	82203625.....	64
82202910.....	222	82203187.....	115	82203400.....	181	82203626.....	64
82202911.....	224	82203188.....	115	82203401.....	181	82203627.....	63
82202912.....	224	82203189.....	157	82203403.....	138	82203628.....	63
82202919.....	205	82203190.....	157	82203405.....	7	82203629.....	63
82202922.....	205	82203191.....	157	82203417.....	109	82203630.....	63
82202948.....	227	82203192.....	157	82203418.....	109	82203631.....	64
82202955.....	63	82203193.....	157	82203419.....	109	82203632.....	64
82202958.....	262	82203197.....	14	82203430.....	69	82203636.....	230
82202959.....	262	82203235.....	220	82203433.....	69	82203637.....	78
82202960.....	262	82003236.....	220	82203434.....	217	82203638.....	78
82202961.....	228	82203237.....	31	82203435.....	217	82203639.....	78
82202963.....	69	82203243.....	130	82203447.....	177	82203640.....	81
82202979.....	115	82203245.....	138	82203454.....	261	82203641.....	81
82202980.....	115	82203246.....	244	82203455.....	261	82203648.....	122
82202998.....	255	82203247.....	244	82203457.....	95	82203649.....	121
82203036.....	217	82203248.....	37	82203461.....	199	82203650.....	177
82203039.....	191	82203250.....	37	82203465.....	14, 15	82203651.....	224
82203040.....	191	82203251.....	37	82203467.....	205	82203652.....	225
82203041.....	191	82203253.....	133	82203469.....	205	82203654.....	225
82203042.....	190	82203257.....	237	82203470.....	205	82203655.....	219
82203043.....	191	82203259.....	59	82203471.....	162	82203656.....	219
82203044.....	191	82203260.....	59	82203472.....	171, 172	82203657.....	219
82203045.....	191	82203261.....	59	82203473.....	219	82203658.....	219
82203046.....	190	82203264.....	64	82203474.....	171, 172	82203659.....	219
82203047.....	191	82203265.....	64	82203488.....	250	82203660.....	219
82203048.....	191	82203266.....	63	82203489.....	92	82203661.....	261
82203049.....	191	82203280.....	138	82203490.....	92	82203662.....	261
82203050.....	190	82203285.....	51	82203491.....	97	82203663.....	95
82203051.....	191	82203286.....	51	82203503.....	195	82203667.....	7
82203052.....	191	82203287.....	51	82203505.....	195	82203668.....	198
82203053.....	191	82203290.....	42	82203508.....	195	82203669.....	198
82203054.....	190	82203293.....	42	82203509.....	195	82203671.....	78
82203059.....	191	82203294.....	42	82203525.....	109	82203672.....	261
82203060.....	191	82203295.....	42	82203548.....	186	82203675.....	264
82203061.....	191	82203297.....	191	82203550.....	186	82203676.....	262
82203062.....	190	82203298.....	191	82203561.....	184	82203677.....	262
82203073.....	208	82203299.....	190	82203562.....	184	82203683.....	227
82203074.....	208	82203303.....	100	82203563.....	184	82203685.....	227
82203079.....	208	82203313.....	191	82203564.....	184	82203691.....	142
82203111.....	248	82203315.....	190	82203588.....	195	82203692.....	142
82203112.....	248	82203316.....	238	82203589.....	195	82203693.....	144
82203113.....	248	82203317.....	136	82203592.....	177	82203694.....	144
82203121.....	4	82203320.....	136	82203593.....	231	82203695.....	97
82203122.....	241	82203322.....	136	82203595.....	37	82203696.....	97
82203124.....	241	82203340.....	109	82203596.....	37	82203703.....	224, 225
82203125.....	241	82203341.....	109	82203597.....	37	82203704.....	224
82203128.....	234	82203342.....	109	82203598.....	37	82203705.....	224, 225
82203129.....	234	82203351.....	175	82203599.....	37	82203706.....	224, 225
82203130.....	234	82203352.....	214	82203600.....	126	82203707.....	224, 225
82203131.....	234	82203376.....	69	82203601.....	126	82203712.....	101
82203132.....	234	82203377.....	69	82203602.....	126	82203713.....	101
82203133.....	234	82203378.....	94	82203603.....	126	82203714.....	101
82203134.....	234	82203379.....	6	82203604.....	69	82203715.....	101
82203136.....	234	82203380.....	7	82203607.....	250	82203716.....	101
82203137.....	234	82203381.....	78	82203608.....	250	82203717.....	101
82203138.....	234	82203382.....	78	82203612.....	100	82203718.....	101
82203153.....	100	82203388.....	201	82203613.....	100	82203719.....	101
82203157.....	37	82203390.....	201	82203618.....	219	82203720.....	101

PART NUMBER INDEX (CONT.)

PART NUMBER	PAGE	PART NUMBER	PAGE	PART NUMBER	PAGE	PART NUMBER	PAGE
82203726	211	82203907	97	82204018	206	82204199	259
82203728	79	82203908	97	82204019	206	82204204	231
82203729	71	82203909	94	82204020	206	82204205	228
82203732	71	82203912	94	82204021	206	82204206	228
82203735	69	82203914	94	82204022	206	82204210	88
82203736	69	82203918	94	82204023	206	82204211	88
82203739	69	82203919	94	82204025	206	82204212	88
82203740	69	82203920	244	82204055	64	82204229	23
82203754	95	82203921	244	82204057	54	82204234	89
82203755	95	82203922	111	82204061	4	82204235	138
82203756	95	82203923	111	82204073	222	82204262	79
82203763	84	82203924	111	82204074	125	82204265	6
82203764	84	82203925	111	82204082	227	82204267	263
82203765	84	82203926	111	82204085	227	82204268	88
82203766	84	82203927	209	82204087	227	82204269	42
82203768	88	82203928	209	82204091	130	82204282	253
82203771	95	82203929	209	82204094	15	82204284	92
82203772	95	82203930	209	82204101	171, 172	82204287	206
82203773	95	82203931	191	82204106	37	82204288	206
82203786	64	82203932	191	82204107	37	82204289	206
82203787	212	82203933	191	82204109	37	82204291	206
82203789	64	82203934	190	82204111	37	82204292	206
82203795	45	82203935	190	82204112	37	82204294	206
82203796	115	82203936	191	82204114	37	82204295	206
82203797	115	82203937	191	82204119	122	82204296	206
82203798	115	82203938	190	82204120	257	82204298	206
82203799	115	82203939	191	82204121	257	82204299	206
82203800	115	82203940	191	82204123	125	82204301	34
82203803	111	82203941	191	82204124	46	82204304	198
82203804	111	82203942	190	82204126	46	82204307	45
82203805	111	82203943	94	82204128	274	82204310	54
82203807	111	82203946	94	82204132	274	82204311	50
82203826	209	82203947	94	82204133	274	82204313	67
82203828	209	82203948	94	82204135	274	82204314	6
82203829	209	82203950	94	82204141	205	82204316	67
82203830	209	82203951	94	82204143	205	82204317	67
82203836	100	82203953	94	82204144	205	82204319	186
82203837	100	82203954	94	82204146	205	82204321	6
82203839	212	82203956	94	82204150	6	82204322	6
82203853	92	82203960	94	82204151	6	82204323	6
82203855	92	82203961	94	82204158	195	82204324	6
82203856	95	82203962	94	82204159	195	82204326	186
82203857	95	82203963	94	82204160	246	82204327	186
82203859	95	82203964	94	82204161	246	82204328	159
82203864	224, 225	82203965	94	82204162	246	82204329	186
82203865	224, 225	82203978	44	82204163	246	82204331	186
82203866	225	82203979	44	82204165	246	82204332	57
82203867	224	82203980	44	82204167	246	82204333	186
82203868	224	82203981	50	82204174	67	82204342	226
82203869	224	82203982	50	82204175	67	82204344	166
82203870	224	82203983	50	82204176	65	82204348	143
82203871	225	82203984	177	82204177	65	82204349	143
82203873	224	82203999	190	82204179	266	82204350	143
82203874	225	82204000	190	82204180	266	82204353	219
82203875	224, 225	82204001	190	82204181	266	82204354	219
82203876	224, 225	82204002	190	82204182	266	82204363	213
82203890	33	82204003	190	82204183	266	82204364	213
82203896	33	82204004	190	82204184	266	82204365	100
82203899	235	82204005	142	82204185	266	82204366	246
82203903	97	82204010	64	82204186	266	82204368	246
82203904	97	82204014	64	82204190	266	82204370	246
82203905	97	82204015	64	82204191	29	82204374	246
82203906	97	82204017	111	82204193	231	82204376	246

PART NUMBER INDEX (CONT.)

PART NUMBER	PAGE	PART NUMBER	PAGE	PART NUMBER	PAGE	PART NUMBER	PAGE
82204378.....	246	82204492.....	112	82204585.....	109	82204685.....	88
82204380.....	246	82204497.....	177	82204587.....	109	82204686.....	88
82204382.....	246	82204498.....	29	82204588.....	109	82204688.....	85
82204386.....	246	82204499.....	274	82204589.....	109	82204691.....	8
82204388.....	246	82204502.....	261	82204590.....	113	82204692.....	12
82204390.....	246	82204503.....	138	82204591.....	113	82204697.....	167
82204391.....	94	82204504.....	67	82204592.....	113	82204698.....	155
82204393.....	94	82204505.....	67	82204594.....	113	82204699.....	155
82204394.....	94	82204506.....	222	82204595.....	199	82204700.....	164
82204400.....	100	82204510.....	131	82204596.....	199	82204701.....	174
82204401.....	100	82204511.....	131	82204598.....	199	82204703.....	216
82204402.....	100	82204513.....	261	82204599.....	199	82204704.....	216
82204404.....	100	82204514.....	71	82204601.....	238	82204705.....	216
82204405.....	100	82204516.....	71	82204602.....	128, 129	82204706.....	250
82204406.....	264	82204518.....	54	82204605.....	197	82204708.....	264
82204409.....	93	82204519.....	102	82204606.....	197	82204709.....	121
82204410.....	93	82204521.....	219	82204607.....	34	82204710.....	122
82204411.....	93	82204522.....	219	82204616.....	105	82204711.....	122
82204412.....	93	82204528.....	63	82204618.....	229	82204712.....	121
82204413.....	93	82204529.....	219	82204619.....	54	82204713.....	121
82204414.....	93	82204530.....	219	82204620.....	227	82204714.....	121
82204415.....	231	82204531.....	224	82204621.....	227	82204715.....	12
82204418.....	138	82204534.....	45	82204624.....	12	82204716.....	12
82204422.....	64	82204535.....	64	82204625.....	13	82204721.....	130
82204424.....	67	82204536.....	64	82204626.....	13	82204724.....	130
82204427.....	79	82204537.....	64	82204627.....	15	82204725.....	130
82204430.....	95	82204539.....	206	82204628.....	125	82204729.....	180
82204431.....	95	82204544.....	195	82204630.....	125	82204730.....	16
82204432.....	95	82204545.....	94	82204631.....	65	82204731.....	211
82204434.....	8	82204549.....	225	82204633.....	252	82204732.....	211
82204439.....	50	82204550.....	220	82204634.....	130	82204733.....	180
82204440.....	50	82204551.....	94	82204637.....	131	82204734.....	122
82204443.....	13	82204552.....	261	82204638.....	130	82204735.....	268
82204444.....	13	82204553.....	252	82204639.....	130	82204737.....	131
82204445.....	13	82204554.....	249	82204640.....	130	82204738.....	6
82204450.....	61	82204555.....	253	82204641.....	130	82204742.....	2
82204452.....	159	82204556.....	254	82204644.....	131	82204745.....	197
82204453.....	159	82204557.....	254	82204645.....	128, 129	82204752.....	186
82204454.....	169	82204558.....	256	82204646.....	26	82204756.....	101
82204455.....	169	82204559.....	255	82204647.....	26	82204757.....	101
82204461.....	122	82204560.....	69	82204649.....	216	82204759.....	92
82204464.....	122	82204561.....	69	82204650.....	216	82204760.....	92
82204466.....	79	82204562.....	69	82204651.....	216	82204767.....	199
82204467.....	49	82204563.....	71	82204652.....	216	82204768.....	199
82204468.....	49	82204564.....	71	82204653.....	28	82204769.....	199
82204469.....	49	82204565.....	69	82204654.....	216	82204770.....	122
82204470.....	232	82204566.....	69	82204660.....	180	82204771.....	121
82204471.....	232	82204567.....	71	82204661.....	180	82204774.....	58
82204472.....	232	82204568.....	71	82204663.....	63	82204775.....	58
82204473.....	183	82204569.....	71	82204666.....	1	82204783.....	133
82204474.....	183	82204570.....	95	82204667.....	1	82204787.....	51
82204475.....	183	82204571.....	96	82204669.....	95	82204789.....	78
82204476.....	183	82204572.....	96	82204670.....	95	82204798.....	177
82204477.....	183	82204573.....	96	82204673.....	101	82204799.....	45
82204478.....	183	82204574.....	96	82204674.....	101	82204800.....	228
82204480.....	183	82204575.....	96	82204675.....	100	82204801.....	228
82204481.....	183	82204577.....	183	82204676.....	100	82204802.....	101
82204482.....	183	82204579.....	109	82204677.....	95	82204803.....	101
82204485.....	183	82204580.....	109	82204678.....	95	82204804.....	131
82204486.....	257	82204581.....	109	82204679.....	92	82204805.....	50
82204487.....	257	82204582.....	109	82204680.....	92	82204806.....	50
82204488.....	211	82204583.....	109	82204681.....	86	82204807.....	50
82204489.....	211	82204584.....	109	82204682.....	88	82204808.....	28

PART NUMBER INDEX (CONT.)

PART NUMBER	PAGE	PART NUMBER	PAGE	PART NUMBER	PAGE	PART NUMBER	PAGE
82204809.....	28	82204930.....	112	82205059.....	205	82205168.....	101
82204810.....	25	82204931.....	266	82205060.....	205	82205169.....	101
82204811.....	101	82204932.....	266	82205061.....	59	82205170.....	101
82204812.....	101	82204933.....	266	82205062.....	59	82205171.....	101
82204813.....	100	82204934.....	266	82205063.....	208	82205176.....	197
82204819.....	227	82204935.....	72	82205064.....	59	82205177.....	197
82204821.....	227	82204936.....	72	82205065.....	208	82205178.....	100
82204822.....	227	82204937.....	266	82205066.....	208	82205179.....	100
82204824.....	227	82204938.....	266	82205067.....	47	82205180.....	93
82204828.....	227	82204939.....	266	82205069.....	242	82205181.....	93
82204830.....	227	82204940.....	6	82205070.....	242	82205182.....	92
82204832.....	227	82204946.....	2,26	82205071.....	242	82205183.....	92
82204834.....	28	82204947.....	2,26	82205072.....	242	82205184.....	234
82204837.....	138	82204950.....	2	82205073.....	242	82205187.....	262
82204838.....	54	82204952.....	2	82205074.....	242	82205188.....	229
82204839.....	13	82204954.....	94	82205075.....	242	82205189.....	84
82204849.....	183	82204955.....	94	82205076.....	242	82205190.....	85
82204854.....	165	82204956.....	94	82205077.....	242	82205191.....	126
82204855.....	165	82204957.....	94	82205078.....	242	82205192.....	85
82204856.....	165	82204959.....	63	82205079.....	242	82205193.....	85
82204857.....	167	82204960.....	63	82205080.....	130	82205194.....	4
82204858.....	72	82204961.....	177	82205083.....	130	82205195.....	4
82204859.....	72	82204971.....	105	82205084.....	100	82205210.....	111
82204860.....	72	82204972.....	105	82205085.....	100	82205211.....	111
82204861.....	72	82204973.....	105	82205086.....	100	82205212.....	111
82204862.....	72	82204974.....	105	82205089.....	206	82205213.....	111
82204863.....	72	82204975.....	105	82205091.....	180	82205217.....	235
82204864.....	12	82204986.....	39	82205092.....	220	82205218.....	109
82204870.....	259	82204988.....	264	82205096.....	266	82205219.....	181
82204873.....	254	82204989.....	264	82205097.....	266	82205221.....	199
82204874.....	254	82204990.....	39	82205098.....	4	82205222.....	113
82204876.....	259	82204991.....	262	82205100.....	266	82205223.....	109
82204878.....	21	82204992.....	39	82205101.....	262	82205224.....	244
82204879.....	219	82204993.....	262	82205102.....	262	82205225.....	197
82204880.....	79	82204994.....	39	82205104.....	246	82205226.....	197
82204881.....	258	82204995.....	239	82205105.....	246	82205227.....	197
82204882.....	4	82204996.....	239	82205107.....	160	82205228.....	197
82204883.....	4	82204998.....	239	82205113.....	250	82205229.....	197
82204884.....	4	82205000.....	239	82205114.....	250	82205230.....	197
82204889.....	51	82205001.....	138	82205120.....	139	82205231.....	197
82204890.....	101	82205003.....	35	82205124.....	76	82205232.....	197
82204891.....	101	82205005.....	35	82205126.....	94	82205233.....	197
82204892.....	101	82205006.....	35	82205127.....	186	82205234.....	197
82204893.....	101	82205008.....	33	82205128.....	186	82205235.....	179
82204894.....	101	82205009.....	33	82205129.....	186	82205237.....	165
82204896.....	101	82205010.....	229	82205130.....	186	82205238.....	165
82204897.....	102	82205011.....	92	82205131.....	186	82205239.....	165
82204898.....	102	82205012.....	92	82205132.....	186	82205240.....	165
82204899.....	102	82205013.....	92	82205133.....	186	82205241.....	96
82204900.....	102	82205014.....	92	82205134.....	186	82205242.....	96
82204903.....	206	82205016.....	92	82205142.....	111	82205243.....	63
82204904.....	182	82205017.....	92	82205143.....	111	82205244.....	63
82204906.....	182	82205028.....	33	82205145.....	46	82205245.....	50
82204912.....	191	82205033.....	105	82205146.....	46	82205246.....	50
82204913.....	191	82205046.....	138	82205147.....	211	82205250.....	189
82204914.....	206	82205050.....	205	82205158.....	130	82205251.....	266
82204915.....	206	82205051.....	205	82205161.....	109	82205252.....	266
82204922.....	205	82205052.....	205	82205162.....	109	82205253.....	266
82204923.....	205	82205053.....	205	82205163.....	109	82205254.....	266
82204926.....	112	82205054.....	205	82205164.....	109	82205255.....	266
82204927.....	112	82205055.....	205	82205165.....	2	82205256.....	266
82204928.....	112	82205057.....	205	82205166.....	2	82205257.....	266
82204929.....	112	82205058.....	205	82205167.....	2	82205258.....	266

PART NUMBER INDEX (CONT.)

PART NUMBER	PAGE	PART NUMBER	PAGE	PART NUMBER	PAGE	PART NUMBER	PAGE
82205259.....	266	82205469.....	189	82205718.....	183	82205811.....	14
82205260.....	266	82205470.....	189	82205719.....	183	82205813.....	95
82205261.....	266	82205471.....	189	82205720.....	183	82205814.....	95
82205263.....	28	82205472.....	189	82205721.....	183	82205815.....	95
82205264.....	28	82205473.....	189	82205723.....	183	82205817.....	85
82205265.....	28	82205474.....	95	82205729.....	57	82205818.....	197
82205266.....	95	82205475.....	95	82205730.....	106	82205819.....	197
82205267.....	95	82205476.....	95	82205731.....	106	82205820.....	64
82205268.....	57	82205477.....	57	82205732.....	106	82205821.....	88
82205269.....	57	82205478.....	57	82205733.....	106	82205822.....	86
82205270.....	57	82205479.....	197	82205734.....	106	82205825.....	130
82205273.....	57	82205480.....	197	82205735.....	106	82205833.....	106
82205274.....	57	82205492.....	69	82205736.....	106	82205834.....	88
82205276.....	57	82205577.....	76	82205737.....	106	82205847.....	154
82205306.....	275	82205581.....	264	82205738.....	106	82205849.....	121
82205307.....	12, 13, 14	82205582.....	264	82205742.....	191	82205854.....	220
82205332.....	7	82205583.....	264	82205743.....	191	82205855.....	216
82205333.....	261	82205584.....	264	82205744.....	191	82205856.....	216
82205334.....	177	82205621.....	250	82205745.....	191	82205886.....	88
82205336.....	101	82205622.....	109	82205746.....	191	82205887.....	259
82205337.....	101	82205623.....	109	82205747.....	191	82205888.....	259
82205338.....	266	82205626.....	7	82205762.....	111	82205889.....	175
82205339.....	262	82205656.....	138	82205763.....	111	82205890.....	122
82205342.....	142	82205657.....	138	82205764.....	182	82205891.....	13
82205343.....	142	82205658.....	138	82205765.....	182	82205892.....	15
82205345.....	92	82205659.....	138	82205766.....	182	82205893.....	14
82205351.....	92	82205661.....	139	82205767.....	182	82205894.....	28
82205352.....	131	82205662.....	4	82205768.....	131	82205896.....	264
82205353.....	264	82205663.....	4	82205769.....	131	82205897.....	262
82205355.....	264	82205666.....	4	82205770.....	131	82205898.....	262
82205357.....	91	82205667.....	4	82205771.....	234	82205903.....	6
82205362.....	78	82205668.....	187	82205773.....	148	82205904.....	7
82205363.....	100	82205669.....	187	82205774.....	148	82205905.....	8
82205364.....	100	82205670.....	216	82205775.....	148	82205907.....	50
82205365.....	100	82205677.....	29	82205776.....	93	82205908.....	50
82205371.....	93	82205678.....	29	82205777.....	93	82205909.....	50
82205372.....	93	82205680.....	131	82205778.....	93	82205910.....	50
82205373.....	93	82205681.....	179	82205779.....	92	82205911.....	50
82205374.....	93	82205682.....	179	82205780.....	92	82205912.....	50
82205398.....	186	82205683.....	179	82205781.....	225	82205915.....	79
82205399.....	186	82205684.....	69	82205784.....	190	82205916.....	98
82205443.....	57	82205685.....	69	82205785.....	190	82205917.....	98
82205444.....	216	82205686.....	228	82205786.....	190	82205918.....	98
82205445.....	78	82205687.....	228	82205787.....	23	82205919.....	98
82205447.....	64	82205688.....	228	82205789.....	219	82205920.....	97
82205448.....	64	82205689.....	228	82205790.....	219	82205921.....	97
82205449.....	67	82205690.....	228	82205791.....	125	82205923.....	227
82205450.....	74	82205691.....	228	82205793.....	209	82205924.....	261
82205451.....	138	82205692.....	228	82205794.....	209	82205925.....	222
82205453.....	225	82205693.....	228	82205795.....	209	82205928.....	177
82205454.....	78	82205694.....	228	82205797.....	246	82205930.....	183
82205455.....	50	82205695.....	228	82205798.....	246	82205931.....	183
82205456.....	50	82205701.....	227	82205799.....	246	82205932.....	183
82205457.....	50	82205702.....	236	82205800.....	246	82205933.....	183
82205459.....	51	82205703.....	106	82205801.....	246	82205934.....	183
82205461.....	30	82205704.....	106	82205802.....	246	82205935.....	183
82205462.....	205	82205705.....	106	82205803.....	246	82205936.....	211
82205463.....	205	82205707.....	47	82205804.....	266	82205937.....	211
82205464.....	189	82205708.....	264	82205805.....	266	82205939.....	216
82205465.....	189	82205709.....	57	82205806.....	266	82205940.....	246
82205466.....	189	82205710.....	131	82205807.....	266	82205941.....	188
82205467.....	189	82205716.....	183	82205808.....	266	82205942.....	188
82205468.....	189	82205717.....	183	82205809.....	266	82205943.....	188

PART NUMBER INDEX (CONT.)

PART NUMBER	PAGE	PART NUMBER	PAGE	PART NUMBER	PAGE	PART NUMBER	PAGE
82205944.....	188	82206137.....	227	82206265.....	55	82206350.....	64
82205946.....	98	82206138.....	227	82206268.....	179	82206351.....	64
82205948.....	188	82206139.....	227	82206269.....	179	82206352.....	64
82205949.....	98	82206140.....	227	82206270.....	179	82206353.....	67
82205950.....	98	82206141.....	227	82206275.....	228	82206357.....	125
82205951.....	111	82206142.....	227	82206276.....	228	82206360.....	209
82205952.....	111	82206144.....	227	82206277.....	228	82206361.....	209
82205954.....	95	82206146.....	75	82206278.....	228	82206362.....	209
82205955.....	94	82206147.....	74	82206279.....	228	82206363.....	33
82205956.....	94	82206148.....	74	82206280.....	228	82206364.....	33
82205957.....	94	82206149.....	74	82206281.....	228	82206365.....	33
82205958.....	94	82206150.....	74	82206282.....	228	82206366.....	33
82205959.....	94	82206152.....	75	82206283.....	228	82206372.....	259
82205960.....	94	82206153.....	74	82206284.....	228	82206373.....	261
82205961.....	94	82206154.....	74	82206285.....	228	82206374.....	261
82205962.....	94	82206155.....	75	82206286.....	228	82206375.....	261
82205963.....	94	82206156.....	74	82206287.....	228	82206376.....	261
82205964.....	51	82206157.....	145	82206288.....	228	82206378.....	78
82205965.....	51	82206208.....	95	82206289.....	228	82206380.....	63
82205967.....	78	82206211.....	75	82206290.....	228	82206381.....	63
82205971.....	98	82206212.....	74	82206291.....	228	82206382.....	65
82205972.....	98	82206213.....	74	82206292.....	228	82206383.....	65
82205973.....	98	82206215.....	74	82206294.....	228	82206384.....	65
82205974.....	98	82206216.....	75	82206297.....	259	82206385.....	65
82205975.....	98	82206217.....	74	82206300.....	130	82206386.....	186
82205976.....	98	82206218.....	74	82206301.....	130	82206387.....	67
82205978.....	261	82206219.....	74	82206302.....	93	82206388.....	78
82205981.....	122	82206220.....	75	82206303.....	93	82206389.....	64
82205982.....	227	82206226.....	186	82206304.....	93	82206390.....	64
82205983.....	227	82206227.....	186	82206305.....	93	82206391.....	67
82205984.....	227	82206228.....	186	82206306.....	93	82206392.....	225
82205985.....	45	82206229.....	186	82206307.....	93	82206397.....	221
82205986.....	227	82206230.....	186	82206308.....	93	82206398.....	1
82205987.....	227	82206231.....	186	82206309.....	93	82206399.....	1
82205988.....	227	82206232.....	186	82206310.....	93	82206401.....	273
82205989.....	227	82206233.....	186	82206311.....	93	82206402.....	273
82205990.....	227	82206234.....	186	82206312.....	93	82206403.....	273
82205991.....	227	82206235.....	186	82206313.....	93	82206404.....	273
82205992.....	227	82206236.....	186	82206314.....	93	82206408.....	45
82205993.....	227	82206237.....	186	82206315.....	93	82206410.....	50
82205994.....	171, 172	82206238.....	186	82206316.....	93	82206412.....	275
82206015.....	84	82206239.....	186	82206317.....	247	82206435.....	242
82206016.....	85	82206240.....	186	82206320.....	149	82206439.....	94
82206018.....	57	82206241.....	186	82206321.....	149	82206441.....	94
82206019.....	78	82206242.....	186	82206322.....	149	82206443.....	101
82206021.....	236	82206243.....	186	82206323.....	177	82206445.....	101
82206022.....	236	82206245.....	46	82206324.....	95	82206453.....	212
82206024.....	130	82206246.....	46	82206325.....	95	82206454.....	212
82206026.....	52	82206247.....	46	82206326.....	78	82206455.....	212
82206030.....	95	82206248.....	46	82206327.....	21	82206456.....	200
82206031.....	95	82206249.....	46	82206328.....	52	82206457.....	180
82206033.....	64	82206250.....	46	82206329.....	74	82206458.....	225
82206034.....	64	82206251.....	46	82206330.....	75	82206459.....	220
82206035.....	64	82206252.....	46	82206334.....	211	82206465.....	115
82206036.....	64	82206253.....	46	82206335.....	211	82206468.....	111
82206037.....	67	82206257.....	59	82206336.....	78	82206469.....	111
82206038.....	122	82206258.....	59	82206341.....	58	82206470.....	111
82206040.....	225	82206259.....	59	82206342.....	58	82206471.....	111
82206130.....	247	82206260.....	59	82206343.....	216	82206472.....	111
82206131.....	247	82206261.....	59	82206344.....	28	82206473.....	111
82206132.....	247	82206262.....	59	82206345.....	28	82206474.....	111
82206135.....	4	82206263.....	55	82206346.....	216	82206475.....	111
82206136.....	227	82206264.....	55	82206349.....	64	82206476.....	111

PART NUMBER INDEX (CONT.)

PART NUMBER	PAGE	PART NUMBER	PAGE	PART NUMBER	PAGE	PART NUMBER	PAGE
82206477.....	111	82206568.....	93	82206721.....	197	82206846.....	190
82206478.....	115	82206569.....	93	82206722.....	197	82206847.....	191
82206479.....	111	82206578.....	4	82206723.....	197	82206848.....	191
82206480.....	111	82206579.....	4	82206724.....	197	82206849.....	191
82206481.....	111	82206580.....	4	82206725.....	197	82206850.....	191
82206482.....	220	82206581.....	50	82206726.....	197	82206873.....	253
82206483.....	220	82206582.....	50	82206727.....	197	82206874.....	252
82206491.....	93	82206586.....	22	82206728.....	197	82206880.....	49
82206492.....	93	82206587.....	24	82206729.....	197	82206881.....	49
82206493.....	92	82206588.....	24	82206730.....	197	82206882.....	49
82206494.....	92	82206590.....	197	82206731.....	197	82206883.....	49
82206495.....	92	82206591.....	197	82206732.....	46	82206884.....	252
82206496.....	92	82206592.....	197	82206734.....	46	82206885.....	252
82206497.....	92	82206602.....	246	82206735.....	46	82206887.....	71
82206498.....	92	82206603.....	246	82206737.....	46	82206889.....	71
82206499.....	112	82206604.....	105	82206738.....	197	82206891.....	71
82206501.....	109	82206605.....	198	82206739.....	197	82206893.....	71
82206502.....	109	82206606.....	198	82206740.....	197	82206895.....	71
82206504.....	264	82206607.....	198	82206741.....	197	82206897.....	71
82206505.....	138	82206608.....	198	82206742.....	14	82206899.....	13
82206508.....	264	82206609.....	177	82206743.....	100	82206908.....	227
82206510.....	60	82206615.....	186	82206744.....	100	82206909.....	227
82206511.....	92	82206617.....	186	82206745.....	100	82206910.....	227
82206512.....	92	82206619.....	186	82206746.....	100	82206911.....	37
82206513.....	92	82206620.....	186	82206747.....	100	82206912.....	51
82206514.....	92	82206623.....	252	82206748.....	100	82206913.....	51
82206515.....	92	82206624.....	252	82206749.....	100	82206914.....	51
82206516.....	92	82206625.....	249	82206750.....	100	82206923.....	71
82206517.....	92	82206626.....	249	82206751.....	100	82206924.....	71
82206518.....	92	82206627.....	26	82206752.....	100	82206926.....	71
82206521.....	122	82206629.....	131	82206753.....	100	82206927.....	71
82206522.....	177	82206633.....	14	82206754.....	96	82206928.....	71
82206523.....	50	82206634.....	149	82206755.....	96	82206930.....	69
82206524.....	105	82206635.....	149	82206756.....	100	82206931.....	206
82206525.....	105	82206636.....	149	82206757.....	100	82206932.....	206
82206526.....	50	82206637.....	84	82206758.....	96	82206933.....	206
82206527.....	50	82206638.....	86	82206759.....	96	82206940.....	85
82206528.....	79	82206639.....	88	82206764.....	219	82206958.....	130
82206529.....	67	82206640.....	85	82206765.....	219	82206963.....	209
82206531.....	130	82206642.....	81	82206766.....	219	82206964.....	209
82206533.....	130	82206643.....	90	82206767.....	219	82206965.....	209
82206535.....	67	82206644.....	14	82206768.....	84	82206966.....	209
82206537.....	125	82206647.....	122	82206770.....	84	82206967.....	209
82206538.....	122	82206648.....	122	82206771.....	84	82206968.....	209
82206541.....	205	82206653.....	138	82206773.....	88	82206969.....	217
82206542.....	189	82206655.....	177	82206774.....	85	82206970.....	216
82206543.....	189	82206656.....	177	82206775.....	88	82206971.....	217
82206544.....	209	82206684.....	133	82206776.....	88	82206972.....	59
82206545.....	209	82206685.....	57	82206777.....	88	82206977.....	216
82206546.....	209	82206686.....	97	82206778.....	165	82206985.....	148
82206547.....	183	82206687.....	97	82206782.....	264	82206986.....	148
82206548.....	183	82206688.....	97	82206783.....	264	82206987.....	148
82206549.....	183	82206689.....	97	82206784.....	81	82206988.....	148
82206550.....	183	82206690.....	97	82206785.....	81	82206989.....	148
82206551.....	220	82206691.....	97	82206826.....	125	82206990.....	148
82206552.....	220	82206700.....	220	82206827.....	125	82206991.....	242
82206561.....	93	82206704.....	133	82206831.....	12	82206992.....	246
82206562.....	93	82206708.....	60	82206834.....	216	82207038.....	190
82206563.....	93	82206709.....	183	82206837.....	122	82207039.....	190
82206564.....	93	82206710.....	183	82206838.....	125	82207040.....	190
82206565.....	93	82206712.....	183	82206843.....	81	82207041.....	190
82206566.....	93	82206713.....	183	82206844.....	81	82207042.....	205
82206567.....	93	82206720.....	197	82206845.....	190	82207043.....	205

PART NUMBER INDEX (CONT.)

PART NUMBER	PAGE	PART NUMBER	PAGE	PART NUMBER	PAGE	PART NUMBER	PAGE
82207044.....	205	82300812.....	54	82301022.....	74	82401184.....	40
82207045.....	205	82300813.....	54	82301023.....	75	82401194.....	270
82207135.....	50	82300815.....	59	82301031.....	177	82401195.....	29
82300160.....	268	82300816.....	59	82301034.....	177	82401196.....	29
82300506.....	144	82300817.....	59	82301039.....	139	82401197.....	119, 120
82300512.....	144	82300851.....	63	82301044.....	47	82401199.....	79
82300542.....	172	82300852.....	63	82400553.....	128, 129	82401200.....	40
82300581.....	157	82300853.....	67	82400554.....	128, 129	82401201.....	40
82300585.....	162	82300865.....	46	82400594.....	137, 138	82401202.....	236
82300589.....	168	82300866.....	46	82400709.....	128, 129	82401216.....	119
82300607.....	65	82300867.....	46	82400806.....	103	82401217.....	128, 129
82300608.....	65	82300870.....	220	82400992.....	75	82401218.....	119, 120
82300727.....	92	82300871.....	219	82400999.....	43	82401219.....	119
82300728.....	92	82300875.....	261	82401002.....	145	82401227.....	217
82300731.....	92	82300877.....	144	82401051.....	136	82401228.....	217
82300732.....	92	82300878.....	144	82401052.....	136	82401291.....	220
82300749.....	81	82300879.....	46	82401053.....	136	82401293.....	209
82300755.....	54	82300880.....	46	82401054.....	136	82401294.....	209
82300756.....	67	82300881.....	46	82401071.....	64	82401295.....	209
82300776.....	81	82300887.....	144	82401072.....	67	82401315.....	43
82300777.....	81	82300901.....	54	82401074.....	67	82401316.....	43
82300778.....	80	82300904.....	9	82401075.....	65	82401325.....	34
82300780.....	50	82300905.....	64	82401102.....	119, 120	82401326.....	34
82300781.....	47	82300906.....	64	82401103.....	119, 120	82401333.....	268
82300783.....	67	82300912.....	78	82401104.....	119, 120	82401334.....	217
82300784.....	63	82300930.....	12, 13, 14	82401105.....	119, 120	82401335.....	217
82300792.....	63	82300960.....	78	82401106.....	119	82401342.....	203
82300793.....	224	82300966.....	25	82401107.....	43	82401343.....	203
82300794.....	224	82300967.....	78	82401113.....	273	82401358.....	221
82300795.....	219	82300972.....	212	82401151.....	136	82401359.....	221
82300796.....	219	82300983.....	177	82401152.....	136	82401360.....	221
82300802.....	121	82300984.....	177	82401166.....	40	82401379.....	241
82300808.....	51	82300985.....	86	82401169.....	142	82401380.....	241
82300809.....	51	82300986.....	90	82401180.....	55	82401387.....	74
82300810.....	47	82301009.....	50	82401181.....	142	MR459822.....	23
82300811.....	47	82301011.....	89	82401182.....	142		

MOPAR MERCHANDISING MATERIALS ORDER FORM

CHRYSLER/PLYMOUTH/DODGE/DODGE TRUCK/JEEP®

DESCRIPTION	CAT. NO./ PKG	COST PER PACK	PART NO.	QTY	MAX QTY
CATALOGS/BROCHURES					
Jeep Owner's Bible	Individual	22.00	00PM3361		10
2001 PT Cruiser Accessory Brochure	25	11.75	00PM3441		
2001 Chrysler/Plymouth Minivan Accessories	25	11.75	00PM3520		
2001 Chrysler/Plymouth Passenger Car Accessories	25	11.75	00PM3519		
2001 Dodge Durango Accessory Brochure	25	11.75	00PM3516		
2001 Dodge Truck Accessory Brochure	25	11.75	00PM3518		
2001 Dodge Caravan Accessory Brochure	25	11.75	00PM3517		
2001 Dodge Passenger Car Accessory Brochure	25	11.75	00PM3515		
2001 Jeep Cherokee Accessory Brochure	25	11.75	00PM3514		
2001 Jeep Grand Cherokee Accessory Brochure	25	11.75	00PM3513		
2001 Jeep Wrangler Accessory Brochure	25	11.75	00PM3512		
2000 Chrysler/Plymouth Minivan Accessories	25	9.00	00PM3199		
2000 Chrysler/Plymouth Passenger Car Accessories	25	9.00	00PM3200		
2000 Dodge Durango Accessory Brochure	25	9.00	00PM3201		
2000 Dodge Pickup Accessory Brochure	25	9.00	00PM3202		
2000 Dodge Caravan Accessory Brochure	25	9.00	00PM3203		
2000 Dodge Passenger Car Accessory Brochure	25	9.00	00PM3204		
2000 Jeep Grand Cherokee Accessory Brochure	25	9.00	00PM3205		
2000 Jeep Cherokee Accessory Brochure	25	9.00	00PM3206		
2000 Jeep Wrangler Accessory Brochure	25	9.00	00PM3207		

DESCRIPTION	CAT. NO./ PKG	COST PER PACK	PART NO.	QTY	MAX QTY
ACCESSORY DATA BOOKS					
1999-2000 Dodge Truck	Individual	.80	00PM3240		
1999-2000 Passenger Car	Individual	.80	00PM3241		
1999-2000 Jeep	Individual	.80	00PM3242		
1999-2000 Minivan	Individual	.80	00PM3243		
2000 Audio	Individual	No Charge	00PM3162		1
Trailer Hitch Application Guide	Individual	.80	00PM3009		10
2000 Truck	Individual	.75	00PM3450		
2000-2001 Passenger Car	Individual	.75	00PM3449		
2000 Jeep	Individual	.75	00PM3451		
2000 Minivan	Individual	.75	00PM3452		
2000 Fall Data Book	Individual	3.00	00PM3521		
VEHICLE SECURITY SYSTEMS					
EVS II® & Keyless Entry Brochure	25	No Charge	00PM3174		4
GOLD KEY/ MOPAR ACCESSORY RESIDUALIZATION					
Salesperson Pocket Guide	Individual	No Charge	00PM3247		10
NAVIGATION SYSTEM					
Consumer Brochure	25	No Charge	00PM3372		2
RADIOS					
Upgrade Chassis Return Tag	50	No Charge	00PM1248		2
Radio Upgrade Return Form 2000	Individual	No Charge	00PM1443		5
Audio Systems Wall Chart 2000	Individual	No Charge	00PM3568		2
MASTER SHIELD					
Master Shield Consumer Brochure	25	No Charge	00PM1231		2
Fabric Protector Demo Cards	50	No Charge	00PM1234		2
Master Shield Static Cling Decal	Individual	No Charge	00PM2858		2
AIR CONDITIONING					
2000 Mopar Acc. Svc. Parts Guide	Individual	No Charge	00PM3423		2

MOPAR MERCHANDISING MATERIALS

Available Through **DIAL**

- For speed and convenience, Mopar Merchandising Materials on this Order Form can be ordered through DIAL
- Order materials direct from Mopar as you need them. Input your order as you would a normal weekly stock order or a Daily or Special Handling parts order
- Increase sales and profits with Mopar Merchandising Support Materials

NOTE: Your parts account will be billed for any chargeable items.

Jeep, EVS II, IT-s and Master Shield are trademarks of DaimlerChrysler.

IMPRINTED TIRE COVER PROGRAM

MOPAR IMPRINTED TIRE COVER PROGRAM INSTRUCTIONS

Available in one- or three-color letter imprint
 Fits tire sizes P215/P225 X R15 GSA
 Economy cover also available to fit LT30 X 9.50

The following tire covers are available for dealership imprints, with your design

One-color design — ink color — pick one							Tire Covers with Dealer One-color Imprint					
Black	White	Yellow	Red	Magenta	Blue	Green	Tire size	Color	Vinyl Finish	Part Number	Dir Cost (per piece)	Ord Qty. (Min. 25 per Part #)
							215/225 X 15	Black	Leather	82203735	\$19.00	
							LT 30 X 9.50	Black	Leather	82203376	\$28.00	
							215/225 X 15	Black	Denim	82203736	\$28.50	
							215/225 X 15	White	Denim	82203737	\$30.00	
							215/225 X 15	Spice	Denim	82203738	\$30.00	
							215/225 X 15	Tan	Denim	82204565	\$30.00	
Three-color design — ink color — pick three							Tire Covers with Dealer Three-color Imprint					
Black	White	Yellow	Red	Magenta	Blue	Green	Tire size	Color	Vinyl Finish	Part Number	Dir Cost (per piece)	Ord Qty. (Min. 25 per Part #)
							215/225 X 15	Black	Leather	82203739	\$19.00	
							LT 30 X 9.50	Black	Leather	82203377	\$28.00	
							215/225 X 15	Black	Denim	82203740	\$28.50	
							215/225 X 15	White	Denim	82203741	\$30.00	
							215/225 X 15	Spice	Denim	82203742	\$30.00	
							215/225 X 15	Tan	Denim	82204566	\$30.00	

Prices listed are for printed tire covers only. Artwork, separation, and screen charges listed on the last page.

Dealer Instructions (Orders of 1-24 pieces in any part number will not be accepted):

- 1) Select one- or three-color Imprinting.
 - 2) Select ink color(s) for your design.
- Note: For three-color design indicate color(s) for each word and object on artwork supplied.
- 3) Fill in order quantity (minimum of 25 per part number).
 - 4) Sign this page at bottom.
 - 5) Fill in information form on the last page.
 - 6) Using part numbers listed, place order on DIAL.
 - 7) Send a copy of worksheets and any artwork or separations to:

American Stitchco, Inc.
 421 West Wade
 Mountain Home, AR 72653
 Attn: Chuck Abel
 Phone No: 1-800-903-5667 Fax No: 870-425-4900

**Call 1-800-903-5667 Regarding
 Program Questions, Delivery Time
 And Status Of Order.**

**Artwork May Be On File. Check by
 Calling Number Above.**

 DISTRICT MANAGER

 AUTHORIZED DEALER

IMPRINTED TIRE COVER PROGRAM

IMPRINTED TIRE COVER ARTWORK FORM

Please Fill Out The Tire Cover Order Form Completely.

Note: For replenishment orders, you need only place your order through DIAL. New artwork is not required unless your dealership has decided to change its tire cover design.

Dealership Name: _____ **Date:** _____

Dealer Code: _____ **Phone #:** _____

Street: _____ **Fax #:** _____

City, State, ZIP: _____ **Contact:** _____

DESIGN YOUR OWN TIRE COVER

Silkscreen Artwork Instructions:

- Create text and art in a circle (see figure at right)
- Ensure that you have included all punctuation and that your spelling and abbreviations are correct
- Place any registered logos, if desired (Chrysler, Plymouth, Jeep)
- Indicate desired color(s) for a one- or three-color silkscreen
- Only part number list on this order form can be used for the dealer tire cover program
- Send artwork on disk (with hard copy) or separations with completed copy of order form to:

American Stitchco, Inc.
421 West Wade
Mountain Home, AR 72653
Attn: Chuck Abel
Phone: 1-800-903-5667 Fax: 870-425-4900



- If you have no artwork or just an idea, just mail or fax completed order form, with sketch or description of your idea, to the address above. Let our full-service graphic arts department help in the completion of your order. For prices on artwork, separations and screens refer to the chart below. Artwork, separation, and screen charges are to be paid in advance of order completion and will be billed directly to your dealership. These are one-time charges, unless you change your design after the completion of this order

ARTWORK AND SILKSCREEN CHARGES

SERVICE	DESCRIPTION	COST	NOTE
Artwork	Artwork, if provided, must be on a 3.5-inch computer floppy disk (with a hard copy included). Acceptable file extensions are: .bmp .tif .pcx .ai .eps .cdr. Bitmaps must be of high resolution and at least 75% of final image size separations, if provided, must be right reading, emulsion up	\$20.00 per hr	Send us a fax of your idea for tire cover artwork and we will be glad to give you a quote.
Film Separations	Film positives with good resolution and density at the same size will appear on the tire cover. Multi-color separations need to have ample amount of trap on preceding orders	\$60.00 Per color	Usefulness of customer provided separations will be determined by the vendor.
Screen Rental & Exposure	Extensive variables in screen production, such as mesh count, frame size, emulsion type, and mesh tension, prohibit the usage of customer provided screens	\$20.00 per screen	This cost includes screen stretch, coating, exposure, and maintenance.

As part of the DaimlerChrysler family, Mopar makes Original Equipment parts and accessories for Chrysler, Plymouth, Dodge and Jeep vehicles. This means that the same corporate team that designed these vehicles has created the accessories featured in this Data Book — utilizing the original designs and specifications. The result? Mopar Accessories that meet a higher standard than aftermarket accessories. Accessories with not just

THE MOPAR DIFFERENCE

level of detail and thought that creates accessories with a real Mopar Difference. A difference in fit. In engineering. In testing. In materials. In safety standards. Even a difference in the way Mopar Accessories are designed to install on the vehicles.

In short, it's a Mopar Difference, in each one of the accessories featured in these pages, that you'll recognize — and appreciate — for years down the road.

an attention to detail, but a dedication to detail. It's this

Materials Testing
Design Installation
Fit Safety

Mopar **Rear Spoilers** must pass many rigorous tests to ensure that they maintain their good looks and do not adversely affect the performance of the vehicle. Testing under extreme hot and cold temperatures checks the Rear Spoilers' ability to withstand severe conditions without cracking. Weather-resistance tests ensure that the spoiler will maintain its premium finish in any climate. Pull tests help ensure that spoilers won't loosen or vibrate. Several other tests make certain that the weight of the spoiler does not affect normal deck lid operation, or compromise the integrity of the deck lid's hinges, latches and lock. Mopar Rear Spoilers, like all Mopar Accessories, are designed and tested for a seamless integration with DaimlerChrysler vehicles.



See Rear Spoilers for more information

Mopar **Brush Guards and Grille Guards** are designed using advanced engineering software that allows engineers to exactly match the front end of any Dodge truck. However, it's more than a perfect fit. Mopar Deluxe Tubular Brush Guards and Grille Guards feature injection-molded ABS plastic components that ensure sturdy construction and a blemish-free surface.

Tubular Brush and Grille Guards are fashioned from heavy-gauge steel, then formed with an advanced mandrel tube-bending technology for a wrinkle-free appearance. The chroming process then includes more nickel to help prevent rust and finish cloudiness.

Furthermore, because Mopar Brush and Grille Guards are engineered by the same corporate team as Dodge Trucks, they're designed to meet Federal Motor Vehicle Safety Standards for occupant protection as well as Federal Vehicle Lighting Requirements. Aftermarket manufacturers may not be subject to these same standards!



See Brush and Grille Guards for more information

Electronic Accessories from Mopar are designed, and thoroughly tested, to guarantee compatibility with DaimlerChrysler electrical systems. Whether you upgrade your audio system or add a security or navigation system, DaimlerChrysler testing facilities help ensure that negative effects from outside interference — such as commercial radio antennas and microwave towers — are almost non-existent.

Testing also helps ensure that Mopar Electronic Accessories will not interfere with your other electrical or computer systems.

In addition, unlike with some other accessories on the market, Mopar Electronic Accessories also meet DaimlerChrysler standards for current draw, so they won't draw down the vehicle's battery under normal conditions. You can be assured that, even with several Mopar Electronic Accessories, lamps won't dim and engines won't stumble or stall.



See Electronic Accessories for more information

Each Mopar **Running Board**, made to fit Minivans, Jeep vehicles or Dodge Trucks exactly, is constructed of a sturdy roll-formed steel substructure which passed a 650-pound static weight bench test, a 400-pound dynamic weight test and a 25-pound side-impact test. That means it'll stand up to daily use from heavy loads and minor impacts, and it'll look good for years to come.

The high-impact-resistant plastic cladding that covers Mopar Running Boards also improves durability — and won't shatter, as fiberglass designs might. In addition, the cladding guards against chipping, fading and cracking. Even the step surfaces feature a slip-resistant material. Furthermore, paint is not just a close match — it's an exact factory-matched color.

A final Mopar Difference — the available Lighted Running Boards are carefully designed so the light shines down on the stepping surface, not in the driver's or passenger's eyes, as with some other products on the market.



[See Premium Running Boards for more information](#)

Mopar **Racks and Carriers** are designed and built to strict Jeep specifications. This more demanding standard is ensured through access to DaimlerChrysler laboratories and testing sites — facilities not available to aftermarket accessory manufacturers.

All Mopar Racks and Carriers are subjected to a series of demanding tests before they are offered. Rack and carrier test tables vigorously shake the products to help ensure durability and stability. Brutal salt-spray testing helps ensure corrosion resistance. A pull test simulates aerodynamic loads that pull against the equipment on the roof rack when driving. Together with high-speed road tests and other proving grounds tests, all these procedures help ensure that racks, carriers and cargo remain securely attached.

In addition, each rack and carrier is custom designed to provide a tight, vibration-free fit — unlike many "universal fit" accessories available — which helps ensure minimal wind noise.



[See Racks and Carriers for more information](#)

Mopar **Wheels** feature tough, cast aluminum construction and are specifically designed for an exact fit on Chrysler, Plymouth, Dodge or Jeep vehicles' wheel hubs — unlike "universal fit" wheels, which mount on the wheel studs. This exact fit means wheels that turn true, which translates into less vehicle vibration and a smoother ride.

Every Mopar Wheel is also designed to be used with existing chrome lug nuts and standard wheel weights. In addition, the surface of both painted and polished wheels is glazed with a Clear Coat finish that requires only a normal washing effort — no tedious repolishing on a regular basis to maintain their like-new appearance, as with some other types of wheels.

To help ensure everyone's safety, each Mopar Wheel also undergoes stringent DaimlerChrysler testing, and must pass many other tests — including a simulated curb-impact test — to meet demanding fit, performance and durability standards.

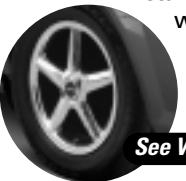

[See Wheels for more information](#)

Mopar offers several **Tubular Products** for Wrangler: Front and Rear Bumpers, Brush Guards, Side Steps and Light Bars. All are designed to blend perfectly with the unique lines of Wrangler, and are available in a variety of finishes.

Mopar tubular products are fashioned from heavy-gauge steel or aluminum, then formed with an advanced mandrel tube-bending technology for a clean, wrinkle-free appearance.

These tubular products are designed to enhance the appearance of Wrangler while resisting road debris and inclement weather conditions without chipping, corroding, pitting or scratching.

All mounting hardware meets DaimlerChrysler Materials Standards for corrosion protection.

In addition, because they're designed and engineered by the same corporate team as Jeep Wrangler, all Mopar front-end products are designed to meet Federal Motor Vehicle Safety Standards for occupant protection as well as Federal Vehicle Lighting Requirements. Aftermarket manufacturers may not be subject to these same standards!



[See Tubular Accessories for more information](#)

MOPAR PARTS & ACCESSORIES LIMITED WARRANTIES

I. WHAT IS WARRANTED

1. MOPAR PARTS BASIC 12-MONTH/12,000-MILE LIMITED WARRANTY

- a. Except as listed below, MOPAR parts sold over the counter or wholesaled are warranted against defects in workmanship or materials for 12 months/unlimited mileage for parts (exchange) only. Parts installed on a Chrysler, Plymouth, Jeep®, or Dodge vehicle by an authorized Chrysler, Plymouth, Jeep or Dodge dealer are warranted for 12 months/12,000 miles for both parts and labor, or for 12 months/unlimited mileage for parts (exchange) only, whichever is more favorable to the customer.
- b. The following MOPAR products have time and mileage limitations, for warranty coverage that differ from the general coverage described above:
 - Accessories including Air Conditioning Systems
 - Batteries
 - Catalytic Converters (if not replaced under the New Vehicle Emissions Limited Warranty)
 - MOPAR Performance Engine Assemblies
 - Master Shield® Protection Products
 - Mufflers, Shocks, Struts and Bedliners
 - MOPAR Remanufactured Parts, Engine Assemblies and ABS Brake Controllers
 - MOPAR Replacement Sheet Metal
 - MOPAR Performance Parts
- c. 12-month/12,000-mile MOPAR Basic Limited Warranty covers the cost of towing a vehicle to the nearest authorized Chrysler, Plymouth, Jeep or Dodge dealer if the failure of a covered part causes the vehicle to be inoperative.
- d. If a MOPAR part is installed in a Chrysler, Plymouth, Jeep or Dodge vehicle by an authorized Chrysler, Plymouth, Jeep or Dodge dealer, and if, while that part is still under warranty, it causes other parts to be damaged or to fail, those other parts will be repaired or replaced under warranty, regardless of whether the other parts were covered by a DaimlerChrysler Motors Corporation warranty at the time of failure. A MOPAR part used to replace a failed MOPAR part that is still under warranty is covered ONLY for the remainder of the replacement part's existing warranty.
- e. MOPAR Gaskets and Seals are sold "AS IS" without warranty of any kind.
 - f. MOPAR Performance Parts (shown by a MOPAR part number beginning with the letter "P") are sold "AS IS" without warranty of any kind by Mopar.

2. MOPAR ACCESSORIES AND AIR CONDITIONING AND AUDIO PRODUCTS SYSTEMS LIMITED WARRANTY

MOPAR Accessories, Audio Products, Electronic Accessories and Air Conditioning Systems installed on a Chrysler, Plymouth, Jeep or Dodge vehicle by an authorized Chrysler, Plymouth, Jeep or Dodge dealer are covered either by the 12-month/12,000-mile MOPAR Basic Limited Warranty above, or by the remainder of the 3-year/36,000-mile Basic New Vehicle Limited Warranty, whichever is more favorable to the customer.

3. MOPAR REPLACEMENT BATTERY 90-DAY LIMITED WARRANTY

- a. Batteries found to be defective in materials or workmanship will be replaced without charge for 90 days from the date of purchase.
- b. Batteries installed in a Chrysler, Plymouth, Jeep or Dodge vehicle covered by the Basic New Vehicle Limited Warranty (Basic Warranty) found to be defective in materials and workmanship are warranted for the remainder of the Basic New Vehicle Limited Warranty, or for the 90 days stated above, whichever is more favorable to the customer.
- c. If the vehicle is no longer covered by the Basic New Vehicle Limited Warranty, and the 90 Day Battery Warranty has expired, the owner may receive a prorated allowance toward the purchase of a new MOPAR replacement battery. This warranty is given only to the original retail purchaser. The prorated amount will be computed by dividing the number of months since the date the battery was purchased (as shown by the date on the customer repair order or parts counter ticket) by the number of months of proration shown on the battery and multiplied by the purchase price of the battery. A battery that fails under the Basic New Vehicle Limited Warranty will be replaced with a MOPAR battery of an equal or next highest amp-hour rating. Batteries that are discharged are NOT considered defective.
- d. Peak Performance Battery 84-Month Limited Warranty (Orbital Battery) — DaimlerChrysler warrants this battery to its original purchaser for 24 months free replacement and 84 months pro-rata replacement when used in private, noncommercial vehicles including up to 1½-ton pickups and vans. The 84 Peak Performance Battery is a starting battery and is not recommended for, or warranted in, non-starting applications. If this battery fails to hold a charge due to a manufacturing defect in materials or workmanship, it will be adjusted with a new battery of comparable performance upon customer payment of the percentage of 84 Peak Performance Battery suggested retail price in effect at the time of adjustment. The RETAILER PURCHASER PERCENTAGE COST used will be based on the following table shown:

Months	0-24	25-36	37-48	49-60	61-72	73-84
Percentage	FREE	43%	57%	71%	86%	98%

MOPAR PARTS & ACCESSORIES LIMITED WARRANTIES (CONT.)

Free replacement period is for 24 months from initial purchase date, regardless of any interim adjustment.

You must retain your dated bill of sale for this battery, along with the removable warranty certificate and present both intact to the adjusting 84 Peak Performance Battery dealer. This warranty does not cover batteries that are simply discharged, abused, neglected, misapplied, or otherwise incapable of vehicle starting for reasons met within that control of DaimlerChrysler Corporation. This warranty does not cover failure due to improper recharging, improper installation, or damage due to freezing, fires, explosions, floods, collisions, or the additions of unapproved materials to electrolyte.

This warranty is limited in duration for the periods identified and applied to initial purchaser and initial vehicle only. This warranty is nontransferable.

4. MOPAR REPLACEMENT CATALYTIC CONVERTER 3-YEAR/25,000-MILE LIMITED WARRANTY

MOPAR replacement Catalytic Converters are warranted against defects in materials or workmanship for three years or 25,000 miles from the date of installation, whichever comes first. The external converter shell and end bushings are warranted against defects in materials or workmanship for 5 years or 50,000 miles from the date of installation, whichever comes first. **IMPORTANT: These catalytic converters are not certified for use as replacements where the vehicle is still covered by the New Vehicle Emissions Warranty. They can only be used after the emissions warranty has expired.**

5. MASTER SHIELD® RUST PROTECTION LIMITED WARRANTY (NEW VEHICLES ONLY)

The Master Shield Rust Protection treatment is warranted for the registered lifetime of the new vehicle, provided that the:

- vehicle does not exceed 11,000-lb gross vehicle weight
- Master Shield treatment was properly applied within three months of the new vehicle's original in-service date

DaimlerChrysler Motors Corporation warrants that if any part of a new vehicle properly treated with Master Shield Rust Protection rusts through (is perforated from inside out), DaimlerChrysler will repair and/or replace the damaged part(s) at no charge, up to a cumulative limit of \$2,000 in combined parts and labor costs per vehicle.

NOTE: This warranty does NOT apply to surface or cosmetic rust; rust caused by external damage from dents, scratches, chipped paint or surface rust resulting from other internal cavity perforation; wear and tear from normal driving; vehicles not continuously registered for road use; vehicle manufacturer's defects; the vehicle's exhaust system; vehicle's floor pans load area of commercial vehicles; pickup truck bed areas; defects covered by a dealer's or manufacturer's New Vehicle Limited Warranties; or vehicles not inspected as required by Master Shield Rust Protection Procedures and Warranty book. Only the selling dealer may validate a Master Shield warranty.

6. MASTER SHIELD PAINT SEALANT LIMITED WARRANTY (NEW VEHICLES ONLY)

The Master Shield Paint Sealant treatment is warranted to the first registered owner only, for a period of three years from the date of its application to the vehicle, provided that:

- the Master Shield sealant was properly applied within 60 days of the vehicle's original in-service date
- damage to the exterior finish is reported immediately to a participating Master Shield dealer, who follows the proper claims-processing procedure

DaimlerChrysler Motors Corporation warrants to the first registered owner of a treated vehicle that if, within three years of the sealant's application on any properly-treated exterior finish, the vehicle is damaged by weather-induced discoloration, loss of gloss or fading, DaimlerChrysler Motors Corporation will repair and retreat the damaged area(s) free of charge, provided that the vehicle is first inspected by a participating Master Shield dealer and is prior authorized by DaimlerChrysler Motors Corporation. This warranty is not transferable.

NOTE: This warranty does NOT apply to damage caused by owner negligence, carelessness or failure to use prescribed maintenance steps; damage caused by collision, fire, stone, or similar objects causing a break or puncture of the sealant; damage from acid rain, smog, industrial fallout, or paints coming in contact with vehicle's surface paint; or damage caused by any modification or alteration to the vehicle's surface.

7. MASTER SHIELD® FABRIC PROTECTOR LIMITED WARRANTY (NEW VEHICLES ONLY)

The Master Shield Fabric Protector treatment is warranted to the first registered owner only, for a period of three years from the date of its application to the vehicle, provided that:

- the Master Shield treatment was properly applied within 30 days of the new vehicle's original in-service date
- the vehicle was at no time in commercial use
- any damage to the interior cloth or velour surfaces is inspected by a participating Master Shield dealer and a representative of the Warranty Record Center

DaimlerChrysler Motors Corporation warrants that if any interior cloth or velour surface treated with Master Shield Fabric Protector becomes permanently stained from water, coffee, soda, milk or similar liquids, DaimlerChrysler Motors Corporation will clean and retreat the damaged surfaces free of charge, provided that the vehicle is first inspected by a participating Master Shield dealer and is previously authorized by DaimlerChrysler Motors Corporation. This warranty is not transferable.

NOTE: This warranty does NOT apply to vehicles used for commercial purposes (except Gold Key Lease® Vehicles); to carpets or floor mats; to damage caused by defects in the material or workmanship of the cloths used; to damage caused by owner negligence, carelessness or improper maintenance; or to damage caused by acid, dye, ink, bleach, gums, paints, lubricants, or caustic or corrosive materials.

MOPAR PARTS & ACCESSORIES LIMITED WARRANTIES (CONT.)

8. MASTER SHIELD LIMITED WARRANTY (WISCONSIN)

These conditions are applicable to the Master Shield Limited Warranty issued in Wisconsin and supersede anything inconsistent in the standard warranty language found on the following pages. All other standard warranty terms and conditions herein contained apply.

The Master Shield Limited Warranty is a two-year warranty renewable for the life of the vehicle if the required free inspections are made. Registration of the warranty is not a condition precedent to your limited warranty coverage nor are manufacturer defects excluded, except for such defects that would be covered under the DaimlerChrysler Corporation new vehicle warranty.

Chrysler Insurance Company, 27777 Franklin Road, Southfield, MI 48034, provides Master Shield with product guarantee legal liability insurance. The warrantor is DaimlerChrysler Corporation, 26311 Lawrence Avenue, Center Line, MI 48015.

For warranty information, claims and adjustments, contact the selling dealer or any participating Master Shield dealer. If dealer is not available, contact 1-800-776-7556.

9. MOPAR REPLACEMENT MUFFLER, SHOCK, STRUT, AND PICKUP BEDLINER LIFETIME LIMITED WARRANTIES

MOPAR replacement Mufflers, Shocks, Struts, and Pickup Truck Bed Liners sold by an authorized Chrysler, Plymouth, Jeep®, or Dodge Dealer are warranted against defects in workmanship or materials for the lifetime of the vehicle on which they are installed. This warranty is given only to the original retail purchaser, and is not transferable.

10. MOPAR PERFORMANCE PARTS 12-MONTH LIMITED WARRANTY

• Mopar Performance Crate Engine Assemblies

MOPAR Performance Crate Engine Assemblies — Crate Engine Assemblies are warranted for “parts only” “AS DELIVERED” against defects in materials or workmanship for 90 days from date of purchase. The following covered components for Performance Engine Assemblies, which prove to be defective in materials or workmanship, will be replaced on an exchange basis for 90 days: cylinder blocks and all internal parts; cylinder head assemblies; intake manifold; core plugs; valve covers; oil pan; timing gear and/or chain and cover; water pump; gasket and seals.

• Mopar Performance Parts beginning with the letter “P”

Mopar Performance Parts (shown by a Mopar part number beginning with the letter “P”) are sold “AS IS” without warranty of any kind by Mopar Parts.

WARNING: All Mopar Performance Parts beginning with the letter “P” are sold “AS IS” without any warranty whatsoever. All express and implied warranties, including warranties of merchantability or fitness for a particular purchase, are excluded. The entire risk as to quality and performance of such parts is with the buyer. Should such parts prove defective following their purchase, the buyer, and not the manufacturer, distributor, or the retailer, assumes the entire cost of all necessary servicing and repair. Note that all Chrysler, Plymouth, Dodge, Dodge Truck and Jeep vehicle and part warranties are voided if the vehicle or part is used for competition, or if the vehicle or part fails due to modification.

11. GENUINE MOPAR REMANUFACTURED PARTS, ENGINE ASSEMBLIES AND ABX ANTILOCK BRAKE CONTROLLER

All genuine MOPAR Remanufactured Parts are identified by an “R” or “JR” prefix.

- a. MOPAR Remanufactured Parts, except powertrain parts, sold over the counter or wholesaled, are warranted for 12 months/unlimited miles for parts (exchange) only. MOPAR Remanufactured Parts, except powertrain parts, installed on a Chrysler, Plymouth, Dodge or Jeep vehicle by an authorized Chrysler, Plymouth, Dodge or Jeep dealer are warranted for 12 months/12,000 miles parts and labor, or for 12 months/unlimited miles, parts (exchange) only, whichever coverage is more favorable to the customer.
- b. Mopar Remanufactured Powertrain Parts, installed on a Chrysler, Plymouth, Dodge or Jeep vehicle by an authorized Chrysler, Plymouth, Dodge or Jeep dealer, are warranted against defects in materials and workmanship for 36 months or 36,000 miles, whichever occurs first, for parts and labor, from the original date of installation. DaimlerChrysler Motors Corporation, Mopar Parts Division, (“MOPAR”) will repair or replace, at its option, the failed assembly using new or remanufactured parts. This warranty covers the cost of parts and labor when repairs are completed by an authorized Chrysler, Plymouth, Dodge or Jeep dealer.

The 36-month or 36,000-mile Limited Warranty for Mopar remanufactured powertrain assemblies covers the following parts and components.

Gasoline Engines and Cylinder Heads: Cylinder block and all internal parts, cylinder head assemblies, timing gears and timing gear drive belts or chains, oil pumps and rear main oil seals.

Manual or Automatic Transmissions/Transaxles: Case and all internal parts, torque converter (including ring gear), front pump seals.

- c. Mopar Remanufactured Powertrain Parts, sold over the counter, are warranted against defects in materials and workmanship for 36 months or 36,000 miles, whichever occurs first, from the original date of sale by a Chrysler, Plymouth, Dodge or Jeep dealer to an independent repair facility. Repairs, including both parts and labor, can be obtained from any authorized Chrysler, Plymouth, Dodge or Jeep dealer. Alternatively, repairs, including the replacement or repair of the failed assembly and an allowance for labor, may be made by the purchasing independent repair facility. The independent repair facility must obtain authorization for any repair from MOPAR or an authorizing entity designated by MOPAR for this purpose. This repair may include the repair or replacement of the failed assembly at the option of MOPAR or the authorizing entity.

MOPAR PARTS & ACCESSORIES LIMITED WARRANTIES (CONT.)

- d. The MOPAR warranty on remanufactured powertrain parts is transferable to subsequent owners of the vehicle in which the Mopar remanufactured powertrain part was originally installed. Simply provide the original repair receipt and the Warranty Registration to the subsequent vehicle owner.
- e. Remanufactured Cummins Diesel Engine Assemblies installed on a Dodge vehicle by an authorized Chrysler, Plymouth, Dodge or Jeep® dealer are warranted against defects in materials or workmanship for 12 months or 100,000 miles, whichever comes first. Cummins Diesel Engine Assemblies will be repaired by an authorized Chrysler, Plymouth, Dodge or Jeep dealer, using genuine MOPAR remanufactured parts only. Cummins Diesel Engine Assemblies sold over the counter are warranted against defects in materials and workmanship, for 12 months/unlimited miles, for parts (exchange) only.
- f. MOPAR Remanufactured Antilock Brake Controller (ABX-4) sold over the counter or wholesaled are warranted for 12 months/unlimited mileage for parts (exchange) only. MOPAR Remanufactured Antilock Brake Controller (ABX-4) installed on a Chrysler, Plymouth, Dodge or Jeep vehicle by an authorized Chrysler, Plymouth, Dodge or Jeep dealer are warranted from date of installation, for 12 months/12,000 miles parts and labor, or for 12 months/unlimited miles, parts (exchange) only, whichever coverage is more favorable to the customer.

12. MOPAR REPLACEMENT OUTER-PANEL SHEET METAL 7-YEAR/UNLIMITED-MILE LIMITED ANTICORROSION WARRANTY

MOPAR replacement Sheet Metal Panels (outer panels) are warranted against defects in materials or workmanship which cause perforation (inside-out rust through only) for 7 years/unlimited miles. Panels, which prove defective, will be repaired or replaced at the option of DaimlerChrysler Motors Corporation. This warranty does not cover corrosion due to fire, accident, vehicle abuse, owner negligence or vehicle alteration; corrosion caused by sand, hail, airborne fallout, chemicals, salt, road hazards or stone damage; or surface paint deterioration or corrosion (other than inside-out perforation). This warranty covers the cost of both parts and labor for the replacement of outer-panel sheet metal parts, if an authorized Chrysler, Plymouth, Jeep or Dodge dealer or its authorized agent installed the part(s). Parts only are covered, if the parts were sold over the counter.

II. HOW TO OBTAIN MOPAR WARRANTY SERVICE

Where both parts and labor are covered warranty items, repairs will be made by any Chrysler, Plymouth, Jeep® or Dodge dealer at no charge. Where parts only are covered, any Chrysler, Plymouth, Jeep or Dodge dealer will provide replacement parts at no charge. It is recommended that you take your Chrysler, Plymouth, Jeep or Dodge vehicle to your selling dealer or to the dealer who sold or installed your MOPAR part or accessory. However, you may obtain replacement parts or service under warranty from any authorized Chrysler, Plymouth, Jeep or Dodge dealer. Except in an emergency, warranty service for MOPAR Panels may be obtained ONLY at an authorized Chrysler, Plymouth, Jeep or Dodge dealer.

III. WHAT IS NOT COVERED

MOPAR warranties do not cover any non-DaimlerChrysler Corporation or non-MOPAR parts, components or equipment, such as a non-MOPAR radio or speed control. These warranties also do not cover the costs of any repairs or adjustments that might be caused by or needed because of the use or installation of non-DaimlerChrysler Corporation or non-MOPAR parts, equipment, materials or additives.

MOPAR warranties do not cover the costs of repairing damage or conditions caused by fire or accident; by abuse, negligence, or misuse (for example, driving over curbs, or overloading or racing the vehicle); by improper adjustment, alteration or failure to maintain the vehicle on which they are installed; or corrosion or damage caused by the use of caustic materials.

MOPAR limited warranties do not cover parts installed on a vehicle used for racing or competition, nor do they cover the repair of any damage or conditions caused by racing or competition.

MOPAR limited warranties do not cover the costs of repairing or replacing any part due to damage caused by poor or improper maintenance, contaminated fuels, or the use of fuels, oils, lubricants or fluids of a type other than those recommended in your Owner's Manual.

MOPAR warranties do not cover the costs of damage caused by environmental factors or Acts of God. "Environmental factors" include such items as airborne fallout, chemicals, tree sap, salt, ocean spray and road hazards. "Acts of God" include such things as hail, floods, windstorms, lightning, tornadoes, sandstorms and earthquakes.

MOPAR warranties do not apply to parts installed on a vehicle, that has had its odometer or emissions systems tampered with or disconnected, or that has been declared to be a total loss by any insurance company, or is rebuilt after being declared to be a total loss; or is issued a certificate of title indicating that it is designated as "salvage," "junk," "rebuilt" or words of similar import. DaimlerChrysler Motors Corporation will deny warranty coverage without notice if it finds that a vehicle is ineligible for warranty coverage because it has been salvaged or declared a total loss as set forth in the above paragraph.

MOPAR Limited Warranties do NOT cover any incidental or consequential damages connected with the failure of the part under warranty. Such damages include lost time; inconvenience; the loss of the use of your vehicle; the cost of rental cars, gasoline, telephone, travel or lodging; the loss of personal or commercial property; or the loss of revenue. Some states do not allow the exclusion or limitation of incidental or consequential damages, so the above limitations or exclusions may not apply to you.

Your warranties can also be restricted by DaimlerChrysler Motors Corporation, as set forth in the New Vehicle Limited Warranty. If your new vehicle limited warranty is restricted by DaimlerChrysler Motors Corporation, coverage under your MOPAR Parts and Accessories Limited Warranties may also be restricted or denied.

MOPAR PARTS & ACCESSORIES LIMITED WARRANTIES (CONT.)

IV. OTHER TERMS

- a. To the extent allowed by law, any implied warranties, including any implied warranty of merchantability or fitness for a particular purpose, are limited in duration to the duration of these express warranties. To the extent allowed by law, if the parts are installed on a vehicle used primarily for business or commercial purposes, no implied warranties apply. **Some states do not allow limitations on how long an implied warranty lasts, so the above limitations may not apply to you.**
- b. These warranties are the only express warranties made by DaimlerChrysler Motors Corporation for MOPAR Parts and Accessories. Except where prohibited by law, this warranty is the sole and exclusive remedy.
- c. NO person, including a dealer or employee of DaimlerChrysler Corporation or DaimlerChrysler Motors Corporation, has the authority to vary or change these warranties.
- d. Michigan law governs this warranty to the extent allowed by law. Interpretation of the terms of this warranty must be done using Michigan law.
- e. **These limited warranties give you specific legal rights and you may also have other rights which vary from state to state.**

NOTE TO DEALER:

MOPAR WARRANTY REGISTRATION & REPLACEMENT PROCEDURES

The Dealer must notify DaimlerChrysler Corporation whenever you install a MOPAR Air Conditioning system, Radio, Speed Control unit, Master Shield, EVS[®] unit, or a MOPAR Accessory. Transmit the vehicle option update information through your DIAL Main Screen. Choose Option 14, Vehicle Information Plus (VIP), following the procedures outlined in your DIAL Dealer's Manual.

ATTENTION INTERNATIONAL DEALERS AND DISTRIBUTORS:

1. The accessories in this Data Book were designed, engineered and approved for use in the United States, Canada and Mexico and may not comply fully with regulations in your country. Before ordering these accessories, please confirm that they meet all local regulations.
2. Special discounts, display items, promotional offers and supplier ship direct (SSD) shipments apply only to the United States, Canada and Mexico.

HOW TO READ THIS MOPAR ACCESSORIES DATA BOOK

The **Alphabetical Index** is just what says – and index of accessories listed alphabetically. You do need to look under the general **name** of the part, not the **type** of part, however. For example, Molded Running Boards are not listed under “M.” Molded is the type of Running Board. They are indexed under “R,” like this: Running Boards, Molded.

The same goes for a Tubular Side Step. It is indexed under “S,” like this: Side Steps, Tubular.

The **Numerical Index** lists accessories by part number from lowest to highest.

In addition, photos, a list of Mopar features, questions to ask about aftermarket competitors and installation information add to the reader-friendly layout.

INSTALLATION TIMES

The installation times listed are average times required to install the accessory, as established by DaimlerChrysler. These installation times are a guide. Actual installation times may vary depending on the technician’s speed, skill level and product knowledge. If it is felt that the published time is not appropriate, submit a “Letter of Information or Suggested Time Schedule Review” as suggested in the back of the Labor Operations Time Schedule book.

ADD-A-TRUNK



Add-A-Trunk (shown on Wrangler)

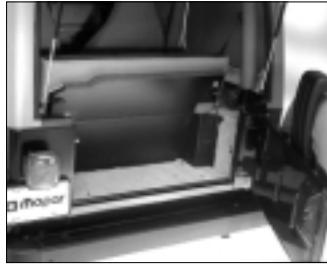

Lockable trunk space

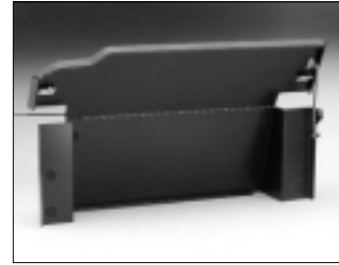

With hinged lid for easy access

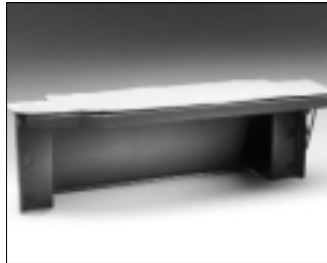

Lid down keeps valuables out of sight

MOPAR FEATURES	COMPETITORS?*
<ul style="list-style-type: none"> • Keeps your valuables out of sight and secure • Makes use of the tailgate door and lock to secure your personal possessions • Creates three cubic feet of lockable trunk space • Optional carpet cover available to match interior color • Mopar Accessories are covered by either the 3-year/36,000-mile New Vehicle Limited Warranty, or the 12-month/12,000-mile Mopar Basic Limited Warranty, whichever is more favorable to the customer 	<ul style="list-style-type: none"> • Does the warranty compare?

*Check your market for your competitive situation.

INSTALLATION:

- Fastens easily in the rear cargo area
- Does not interfere with seat belt operation

Vehicle Line	MYO	MYI	Application Remarks	Part Number	Instl Time	Group	Sugg Retail Price
ADD-A-TRUNK							
Wrangler	2001	1999	Agate, carpet kit, use w/PN 82202313	82204666	0.1	T	26.00
	2001	1999	Camel, carpet kit, use w/PN 82202313	82204667	0.1	T	26.00
	2001	1997	Hinged, OE-Style, requires carpet kit	82202313	0.4	T	195.00
	2001	2001	Agate w/White Jeep logo, vehicle must have OEM carpeting for proper fit	82206398	0.4	T	195.00
	2001	2001	Camel w/Black Jeep logo, vehicle must have OEM carpeting for proper fit	82206399	0.4	T	195.00

AIR BAG LOCKS



Air Bag Locks (driver and passenger side)

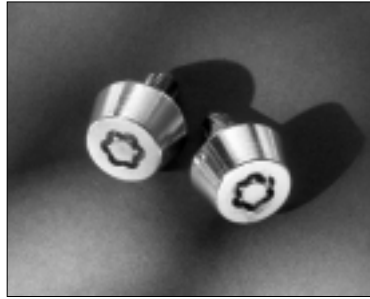

Air Bag Locks (driver's side only)

MOPAR FEATURES	COMPETITORS?*
<ul style="list-style-type: none"> • Theft-resistant puzzle-lock fasteners replace OE fasteners • Exclusive Mopar key codes ensure maximum protection and serviceability • Available on driver's side • Includes window warning label as an additional deterrent • Mopar Accessories are covered by either the 3-year/36,000-mile New Vehicle Limited Warranty, or the 12-month/12,000-mile Mopar Basic Limited Warranty, whichever is more favorable to the customer 	<ul style="list-style-type: none"> • Do fasteners meet OE specifications? • Are they "one size fits all"? • Is a window warning label included? • Does the warranty compare?

*Check your market for your competitive situation.

INSTALLATION:

- Must be installed by qualified technician
- Tool Set required for lock installation.
Call toll-free, (800) 669-8788
(Available to Dealers only)

Vehicle Line	MYO	MYI	Application Remarks	Part Number	Instl Time	Group	Sugg Retail Price
AIR BAG LOCK SETS							
Avenger, Sebring Coupe	2000	1999	Driver's side	82205167	0.5	T	21.00
Breeze, Cirrus, Stratus	2000	1999	Driver's side	82204950	0.2	T	21.00
Cherokee SE	2001	1999	Driver's side	82204946	0.2	T	21.00
Durango, Ram Pickup	2001	1998	Driver's side	82204947	0.2	T	21.00
Grand Cherokee	2001	1999	Driver's side and passenger side	82204742	1.2	T	38.00
Minivan (All)	2001	1998	Driver's side	82204947	0.2	T	21.00
Neon	2001	2000	Driver's side	82205165	0.5	T	21.00
		2000	1999	Driver's side	82204952	0.5	T
Ram Van/Wagon	2000	1999	Driver's side	82205166	0.5	T	21.00
Ram Van/Wagon, Dakota (All)	2001	1999	Driver's side	82204947	0.2	T	21.00

AIR CONDITIONING



Air Conditioning controls
(shown on Truck)



Passenger Car

MOPAR FEATURES	COMPETITORS?*
<ul style="list-style-type: none"> • Designed and tested to meet OE specifications • Original equipment controls, including “fresh air” and “blend air” settings, provide the same appearance and function as OE installations • Original equipment components are used extensively for optimum performance and serviceability • Custom designed for DaimlerChrysler Corporation vehicles • Approved by DaimlerChrysler Corporation Accessory Engineering to ensure superior performance • Interfaces with OE electronics • Uses environmentally friendly R-134a refrigerant • Mopar Accessories are covered by either the 3-year/36,000-mile New Vehicle Limited Warranty, or the 12-month/12,000-mile Mopar Basic Limited Warranty, whichever is more favorable to the customer 	<ul style="list-style-type: none"> • Does it meet OE specifications? • Are components OE quality? • Is it designed for broader vehicle coverage? • Is it an add-on or a cut-and-splice installation? • What refrigerant does it use? • Does the warranty compare?

*Check your market for your competitive situation.

INSTALLATION:

- See Service Manager for details

**NOTE: Aftermarket air conditioning not recommended for Neon.
Installation may void warranty.**

NOTE: For technical assistance, contact the Mopar A/C hot line —
(800) 258-8929, 8 a.m.-5 p.m. Eastern time.

AIR CONDITIONING (CONT.)

Vehicle Line	MY0	MY1	Application Remarks	Part Number	Instl Time	Group	Sugg Retail Price
AIR CONDITIONING — ADDITIONAL COMPONENTS**							
Dakota	2001	2001	Adapter Kit - A/C, 4.7L engine	82206578	2.0	1	
Ram Pickup (All)	2001	1996	Adapter Kit 3.9L, 5.2L, 5.9L R134a	82203121	3.0	1	
	2001	1999	Adapter Kit 3.9L, 5.2L, 5.9L R134a	82204882	1.5	1	
	2001	1999	Adapter Kit 8.0L R134a	82204883	1.5	1	
Ram Van/Wagon -	2001	1998	Camel, Duct Kit for rear air conditioning and heat	82205195	0.3	1	
All	2001	1998	Hose Kit (Rear)	82205194	0.5	1	
AIR CONDITIONING KITS†							
Dakota	2001	2001	Adapter Kit - A/C, 4.7L engine	82206578	2.0	1	
	2000	2000	Dakota 2.5L (Unit Pack) R134a	82205662	3.5	1	
	2000	2000	Dakota 3.9L, 5.2L, 5.9L R134a	82205663	3.5	1	
	2000	2000	AC Adapter Kit for 4.7L new engine belt	82206135	2.0	1	
	2001	1996	Adapter Kit 3.9L, 5.2L, 5.9L R134a	82203121	3.0	1	
	2001	2001	Dakota 3.9L, 5.2L, 5.9L	82206579	3.5	1	
	2001	2001	Dakota 2.5L	82206580	3.5	1	
Ram Pickup (All)	2001	1998	Ram Pick Up 3.9L, 5.2L, 5.9L, 8.0L	82204061	1.5	1	
	2001	1999	Ram Pick Up 5.9L Diesel Unit Pack R134a	82204884	3.0	1	
Ram Van/Wagon -	2001	1998	Air Conditioning - Vans (Rear)	82205098	5.0	1	
All ex. 1500 SWB	2001	1998	Air Conditioning - Vans (Front)	82204059	5.0	1	
Wrangler	2001	2000	2.5L, R-134a	82205666	5.0	1	
	2001	2000	4.0L, R-134a	82205667	5.0	1	

*Mopar A/C Hot Line does not have information to instruct repairs Please refer to your service manual or contact your local zone office technical adviser.

†See the Quarterly A/C Program Owner Guide for all kits and parts that may be required for a complete installation. NA = Unit Pack/No Adapter Kit required.

‡See additional equipment section.

AIR DEFLECTORS, FRONT



Wraparound Bug Deflector
(shown on Voyager)



Wraparound Bug Deflector
(shown on Wrangler)



Bug Deflector with Fender Shields
(shown on Durango)



Bug Deflector with Fender Shields
(shown on Ram Pickup)

MOPAR FEATURES	COMPETITORS?*
<ul style="list-style-type: none"> • Designed and molded to match hood contours • Molded wraparound; fender shields available • Constructed of virtually unbreakable Lexan® • Does not affect windshield wiper or washer operation; creates an airstream that helps direct bugs, grit and road spray up and away from hood and windshield • Features Ram's Head or Jeep® logo • Tested to ensure no mirror flutter • Mopar Accessories are covered by either the 3-year/36,000-mile New Vehicle Limited Warranty or the 12-month/12,000-mile Mopar Basic Limited Warranty, whichever is more favorable to the customer 	<ul style="list-style-type: none"> • Is it a noncontour fit? • Is it constructed of breakable acrylic? • Does the shield affect windshield wiper or washer performance? • Logos are exclusive to Mopar, Jeep, Dodge and DaimlerChrysler Corporation • Will shield disrupt airflow and cause mirror flutter? • Does the warranty compare?

*Check your market for your competitive situation.
Lexan is a registered trademark of General Electric Corporation.

INSTALLATION:

- Installs easily
- Requires 3/8" drill bit for attaching

AIR DEFLECTORS, FRONT (CONT.)

Vehicle Line	MY0	MY1	Application Remarks	Part Number	Instl Time	Group	Sugg Retail Price
AIR DEFLECTORS — FRONT							
Cherokee	2001	1997	Smoke, hood w/ Jeep logo	82203379	0.2	T	72.00
Dakota (All)	2001	1997	Smoke, fender shields	82204321	0.2	T	38.00
	2001	1997	Smoke, hood, w/Ram's Head logo	82202754	0.2	T	72.00
	2001	1997	Smoke, 3-piece set, hood and fender shields	82204322	0.2	T	102.00
Durango	2001	1998	Smoke, fender shields	82204321	0.2	T	38.00
	2001	1998	Smoke, hood, w/Ram's Head logo	82202754	0.2	T	72.00
	2001	1998	Smoke, 3-piece set, hood and fender shields	82204322	0.2	T	102.00
Grand Cherokee	2001	1999	Smoke, hood	82204314	0.2	T	78.00
Minivan (All)	2001	2001	Smoke, hood	82205903	0.2	T	72.00
	2000	1996	Smoke, hood	82204265	0.2	T	69.00
Ram Pickup (All)	2001	1994	Smoke, fender shields	82204323	0.2	T	38.00
	2001	1999	Smoke, wraparound	82202559*	0.2	T	72.00
	2001	1994	Smoke, 3-piece set, hood and fender shields	82204324*	0.2	T	102.00
	2001	1999	Smoke, 3-piece set, hood and fender shields	82204738	0.2	T	102.00
Wrangler	2001	1997	Smoke, fender shields	82202161	0.3	T	60.00
	2001	1997	Smoke, hood	82202160	0.2	T	72.00
DEFLECTORS, MOLDED FRONT — DISCOUNT PURCHASE QUANTITIES							
Dakota (All)	2001	1997	Smoke, wraparound, a pallet consists of 20 per PN 82202754	82204151	0.3		
Durango	2001	1998	Smoke, wraparound, a pallet consists of 20 per PN 82202754	82204151	0.3		
Grand Cherokee	2001	1999	Smoke, wraparound, a pallet consists of 15 per PN 82204314	82204940	0.2		
Ram Pickup (All)	2001	1994	Smoke, wraparound, a pallet consists of 20 per PN 82202559	82204150 [†]	0.3		
Minivan (All)	2000	1996	Smoke, wraparound, a pallet consists of 15 per PN 82204265	82202814	0.2		

*Excludes 2000/1999 Ram Sport Pickup.

[†]Excludes 1999 Ram Sport Pickup.

AIR DEFLECTORS, REAR



Rear Air Deflector (shown on Durango)



Grand Cherokee



PT Cruiser

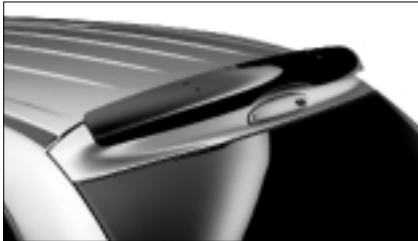

Rear Window Deflector (shown on Minivan)

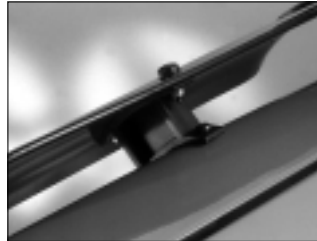

Attachment

MOPAR FEATURES

- Designed and molded to complement vehicle style
- Custom-fit hardware and brackets
- Helps keep rear window cleaner by directing a steady stream of air across the back of vehicle when vehicle is moving
- Constructed of virtually unbreakable Lexan®
- Does not interfere with OE Roof Rack
- Mounts to rear liftgate
- Mopar Accessories are covered by either the 3-year/36,000-mile New Vehicle Limited Warranty or the 12-month/12,000-mile Mopar Basic Limited Warranty, whichever is more favorable to the customer

COMPETITORS?*

- Is it a universal or multifit deflector?
- Is it a universal hardware and bracket package?
- Does it keep rear glass clean?
- Does it contact OE Roof Rack when liftgate is opened?
- Does the warranty compare?

*Check your market for your competitive situation.

INSTALLATION:

- Installs easily
- Includes mounting hardware and installation instructions
- Requires drilling in liftgate
- Dealer installation recommended

Vehicle Line	MY0	MY1	Application Remarks	Part Number	Instl Time	Group	Sugg Retail Price
AIR DEFLECTORS — REAR							
Cherokee	2001	1997	Smoke	82203380	0.3	T	93.00
Durango	2001	1998	Smoke	82203667	0.3	T	99.00
Grand Cherokee	2001	1999	Smoke	82205626	0.3	T	93.00
Minivan (All)	2000	1996	Smoke	82203405	0.5	T	84.50
	2001	2001	Smoke	82205904	0.5	T	86.00
PT Cruiser	2001	2001	Smoke	82205332	0.5	T	84.50

AIR FILTRATION, PASSENGER CABIN

MOPAR FEATURES	COMPETITORS?*
<ul style="list-style-type: none"> • Filters dust and dirt particles smaller than the human eye can see • Reduces pollen, mold and other allergens • Electrostatic process attracts pollutants, allowing for a flow of unrestricted fresh air, versus mechanically trapping particles • Heating, ventilating and air conditioning continue to function as designed • Performs quietly and efficiently • Recommended service replacement within 2 years/24,000 miles • Mopar Accessories are covered by either the 3-year/36,000-mile New Vehicle Limited Warranty, or the 12-month/12,000-mile Mopar Basic Limited Warranty, whichever is more favorable to the customer 	<ul style="list-style-type: none"> • No known comparable product on the market • Does the warranty compare?

*Check your market for your competitive situation.

Vehicle Line	MYO MYI	Application Remarks	Part Number	Instl Time	Group	Sugg Retail Price
PASSENGER CABIN AIR FILTRATION SYSTEM						
Grand Cherokee	2001 1999	Cabin Air Filter, complete assembly	82204691	0.3		32.00
Minivan (All)	2000 1998	Cabin Air Filter, complete assembly	82204434	0.6*		32.00
	2001 2001	Complete kit	82205905	0.2*		32.00

*For vehicles built after 2/19/98.

AUDIO PRODUCTS, ANTENNAS

Vehicle Line	MYO	MYI	Application Remarks	Part Number	Instl Time	Group	Sugg Retail Price
ANTENNAS							
Breeze, Cirrus, Stratus	2000	1995	Complete kit — Power Antenna	82300904	0.5		86.00
Wrangler	2001	1997	Antenna Kit, fixed w/o Mast	82202317	0.4		18.00

AUDIO PRODUCTS, CD CHANGERS



82203465/82202700



82202292



82205892

Six-Disc CD Changer

- Magazine holds six discs for hours of listening pleasure
- Viscous antivibration system prevents skipping
- Available for CD changer-controlled radios and FM-Modulated Kit for complete vehicle coverage
- FM-Modulated Kit (82202292) with credit card-size remote and wired remote provides disc select, random play, fast forward/reverse and track repeat features
- CD Changer incorporates software to interface with DaimlerChrysler Corporation CD changer-controlled radios
- Installation kits sold separately

PT Cruiser Ten-Disc CD Changer

- Complete kit for PT Cruiser equipped w/radios, w/CD controls (RBK/RBB/RBR/RBP/RBZ)
- Operates with CD Changer controls on radio faceplate
- Magazine holds 10 discs for hours of listening pleasure
- Mounts conveniently under either front seat



82204730

Twelve-Disc FM-Modulated CD Changer

- Works with any radio without CD changer controls
- Dual hybrid dampers to help prevent skipping
- Super-fast mechanism for rapid disc changing
- 150-disc programmable title memory
- Silent action for low noise
- Illuminated eject button on changer
- Complete with infrared and wired remote controllers

MOPAR FEATURES

- Mopar CD Changers are guaranteed to be compatible with DaimlerChrysler CD changer-controlled radios
- CD Changer uses viscous silicone dampeners to prevent skipping
- Four-Disc CD Changer is custom fit to existing space in instrument panel in many DaimlerChrysler vehicles, without unsightly adapters
- Custom fit brackets/consoles allow for convenience of use, keeps changer out of sight
- Mopar Accessories are covered by either the 3-year/36,000-mile New Vehicle Limited Warranty, or the 12-month/12,000-mile Mopar Basic Limited Warranty, whichever is more favorable to the customer

COMPETITORS?*

- Does the CD changer control interface with DaimlerChrysler Corporation CD changer-controlled radios?
- Does aftermarket use conventional rubber dampeners that are not as resistant to skipping?
- No known comparable aftermarket product
- Does the warranty compare?

*Check your market for your competitive situation.



Part Number: 82204094 or 82204627
Grand Cherokee Ten-Disc CD Changer

**Grand Cherokee
Ten-Disc CD Changer PN 82204627**

- Magazine holds 10 discs for hours of listening pleasure
- Viscous antivibration system prevents skipping
- CD Changer operated by controls on radio faceplate (RBN/RBR)
- Console lid "hides" changer for added security
- Custom-fit console mounts changer neatly in rear cargo area, off the floor and out of the way



Part Number: 82204094

**Grand Cherokee
Ten-Disc FM-Modulated CD
Changer PN 82204094**

- Magazine holds 10 discs for hours of listening pleasure
- Viscous antivibration system prevents skipping
- Infrared remote and wired instrument panel-mounted controllers provide disc select, random play, fast forward/reverse and track repeat features
- For Grand Cherokee vehicles without CD changer-controlled radios (RAS/RAZ)



Four-Disc Changer

NEW

Four-Disc In-Dash CD Changer

- Four-CD capacity, no magazine, single slot
- Power loading/ejecting function
- Power-disc change shuffling
- Function controlled through radio:
- Random track play function
- Track seek up/down
- Track fast forward/reverse
- Track scan unidirectional (up only)
- Disc up/down
- Available for 2001 model year Neon, Stratus/Sebring Sedan, Sebring Convertible, 300M and Minivan

AUDIO PRODUCTS, CD CHANGERS (CONT.)

Vehicle Line	MYO	MYI	Application Remarks	Part Number	Instl Time	Group	Sugg Retail Price
CD CHANGER INSTALLATION AND CONSOLE KITS							
Avenger, Sebring Coupe	2000	1995	CD Changer Installation Kit for Trunk or underseat mount location. Use with PN 82202700 and radios with CD Controls	82300930	0.6		35.00
	2000	1995	FM Modulated Kit w/credit card-size I/R remote and wired instrument panel controllers, requires 6-Disc CD Changer PN 82202700, works w/any FM radio w/o CD changer controls	82202292*	0.8		55.00
Breeze, Cirrus, Stratus	2000	1999	CD Changer Installation Kit for instrument panel mount, use w/PN 82202700 for radios w/CD controls. For radios w/o CD Controls also order 82202292	82204692	0.5		49.00
Breeze, Cirrus, Stratus, Neon	2000	1995	FM Modulated Kit w/credit card-size I/R remote and wired instrument panel controllers, requires 6-Disc CD Changer PN 82202700, works w/any FM radio w/o CD changer controls	82202292*	0.8		55.00
Cherokee 4-Door	2001	1999	Agate, CD Changer Rear Console Kit, used w/PN 82202700 CD changer, for use with CD control radios, for radios without CD changer controls also order FM-Modulator Kit PN 82202292	82204715	0.4		80.00
	2001	1999	Dark Tan, CD Changer Rear Console Kit, used w/PN 82202700 CD Changer, for use with CD control radios, for radios without CD Changer controls also order FM-Modulator Kit PN 82202292	82204716	0.4		80.00
Cherokee, Wrangler	2001	1997	CD Changer Installation Kit for Trunk or underseat mount location. Use with PN 82202700 and radios with CD Controls	82300930	0.6		35.00
	2001	1997	FM Modulated Kit w/credit card-size I/R remote and wired instrument panel controllers, requires 6-Disc CD Changer PN 82202700, works w/any FM radio w/o CD changer controls	82202292*	0.8		55.00
Concorde, Intrepid, LHS, 300M	2001	1998	CD Changer Installation Kit for Trunk Mount or rear seat location use w/CD Changer PN 82203465 and flush-mount radios w/CD changer controls	82205307	0.5		35.00
	2001	1993	FM Modulated Kit w/credit card-size I/R remote and wired instrument panel controllers, requires 6-Disc CD Changer PN 82202700, works w/any FM radio w/o CD changer controls	82202292*	0.8		55.00
Dakota (All)	2001	2001	CD Changer Installation Kit for Center Console mount use w/6 Disc CD Changer. Also order Din Cord 82205307. Bucket seat vehicles only	82206831	0.6		35.00
	2001	2001	CD Changer Installation Kit for Trunk Mount or rear seat location use w/CD Changer PN 82203465 and flush-mount radios w/CD changer controls	82205307	0.5		35.00
	2001	1986	FM Modulated Kit w/credit card-size I/R remote and wired instrument panel controllers, requires 6-Disc CD Changer PN 82202700, works w/any FM radio w/o CD changer controls	82202292*	0.8		55.00
Durango	2001	2001	CD Changer Installation Kit for Center Console mount use w/6 Disc CD Changer. Also order Din Cord 82205307. Bucket seat vehicles only	82206831	0.6		35.00
	2001	2001	CD Changer Installation Kit for Trunk Mount location use w/PN 82203465 and flush-mount radios w/CD controls	82205307	0.5		35.00
	2001	1998	CD Changer Installation Kit for Center Console mount use w/6-Disc CD Changer. Also order Din Cord PN 82205307). Bucket seat vehicles only	82202292*	0.8		55.00
Grand Cherokee	2001	1999	CD Changer Installation Kit for 10-Disc FM Modulated CD Changer If vehicle has open bin, also order rear CD changer console	82204864	0.8		35.00
	2001	1999	Agate — Rear console for Ten-Disc CD Changers, for radios w/CD controls order PN 82204094 changer, for radios w/o CD controls order CD Changer PN 82204094 and PN 82204864 bracket	82204624	0.2		66.00

*DIN cables are not interchangeable with 82300930 kit.

AUDIO PRODUCTS, CD CHANGERS (CONT.)

Vehicle Line	MYO	MYI	Application Remarks	Part Number	Instl Time	Group	Sugg Retail Price
CD CHANGER INSTALLATION AND CONSOLE KITS (CONT.)							
Grand Cherokee	2001	1999	Camel — Rear console for Ten-Disc CD Changers, for radios w/CD controls order PN 82204094 changer, for radios w/o CD controls order CD Changer PN 82204094 and PN 82204864 bracket	82204625	0.2		66.00
	2001	1999	Taupe — Rear console for Ten-Disc CD Changers, for radios w/CD controls order PN 82204094 changer, for radios w/o CD controls order CD Changer PN 82204094 and PN 82204864 bracket	82204626	0.2		66.00
	2001	2001	Sandstone — Rear console for Ten-Disc CD Changers, for radios w/CD controls order PN 82204094 changer, for radios w/o CD controls order PN 82204094 and PN 82204864 bracket.	82206899	0.2		66.00
Minivan (All)	2000	1996	CD Changer Installation Kit for Trunk or underseat mount location. Use with PN 82202700 and radios with CD Controls	82300930	0.6		35.00
	2000	1996	Camel CD Changer Lower Forward Console Kit, used w/PN 82202700 6-Disc CD changer, for use w/ CD control radios also order Cable 4865035AA, for radios w/o CD changer controls also order FM-Modulated Kit PN 82202292	82204445	0.6		38.00
	2000	1996	Taupe CD Changer Lower Forward Console Kit, used w/PN 82202700 6-Disc CD changer, for use w/ CD control radios also order Cable 4865035AA, for radios w/o CD changer controls also order FM-Modulated Kit PN 82202292	82204839	0.6		38.00
	2000	1996	Mist Gray CD Changer Lower Forward Console Kit, used w/PN 82202700 6-Disc CD changer, for use w/ CD control radios also order Cable 4865035AA, for radios w/o CD changer controls also order FM-Modulated Kit PN 82202292	82204443	0.6		38.00
	2000	1996	Silver Fern CD Changer Lower Forward Console Kit, used w/PN 82202700 6-Disc CD changer, for use w/ CD control radios also order Cable 4865035AA, for radios w/o CD changer controls also order FM-Modulated Kit PN 82202292	82204444	0.6		38.00
	2001	1996	FM Modulated Kit w/credit card-size I/R remote and wired instrument panel controllers, requires 6-Disc CD Changer PN 82202700, works w/any FM radio w/o CD changer controls	82202292*	0.8		55.00
Neon	2001	2000	CD Changer Installation Kit for Trunk Mount or Rear Seat location use w/CD Changer PN 82203465 and flush-mount radios w/CD Changer controls	82205307	0.5		35.00
PT Cruiser	2001	2001	For PT Cruisers w/RAZ radio, use w/CD Changer PN 82202700 and FM Modulator Kit PN 82202292	82205891	0.5		35.00
	2001	2001	FM Modulated Kit w/credit card-size I/R remote and wired instrument panel controllers, requires 6-Disc CD Changer PN 82202700, works w/any FM radio w/o CD changer controls	82202292*	0.8		55.00
Ram Pickup (All)	2001	1994	CD Changer Installation Kit for Trunk or underseat mount location. Use with PN 82202700 and radios with CD Controls	82300930	0.6		35.00
	2001	1994	FM Modulated Kit w/credit card-size I/R remote and wired instrument panel controllers, requires 6-Disc CD Changer PN 82202700, works w/any FM radio w/o CD changer controls	82202292*	0.8		55.00
Ram Van/Wagon	2001	1987	CD Changer Installation Kit for Trunk or underseat mount location. Use with PN 82202700 and radios with CD Controls	82300930	0.6		35.00
	2001	1987	FM Modulated Kit w/credit card-size I/R remote and wired instrument panel controllers, requires 6-Disc CD Changer PN 82202700, works w/any FM radio w/o CD changer controls	82202292*	0.8		55.00
Sebring Convertible	2000	1996	FM Modulated Kit w/credit card-size I/R remote and wired instrument panel controllers, requires 6-Disc CD Changer PN 82202700, works w/any FM radio w/o CD changer controls	82202292*	0.8		55.00

*DIN cables are not interchangeable with 82300930 kit.

AUDIO PRODUCTS, CD CHANGERS (CONT.)

Vehicle Line	MY0	MY1	Application Remarks	Part Number	Instl Time	Group	Sugg Retail Price
CD CHANGER INSTALLATION AND CONSOLE KITS (CONT.)							
Sebring Convertible	2000	1997	CD Changer Installation Kit for instrument panel, use w/PN 82202700 and radios w/CD controls	82203197	0.8		68.00
Sebring Coupe, Stratus Coupe	2001	2001	CD Changer Installation Kit for Trunk Mount or Rear Seat location use w/CD Changer PN 82203465 and flush-mount radios w/CD changer controls	82205307	0.5		35.00
	2001	2001	FM Modulated Kit w/credit card-size I/R remote and wired instrument panel controllers, requires 6-Disc CD Changer PN 82202700, works w/any FM radio w/o CD changer controls	82202292*	0.8		55.00
Viper	2000	1992	CD Changer Installation Kit for Trunk or underseat mount location. Use with PN 82202700 and radios with CD Controls	82300930	0.6		35.00
	2000	1992	FM Modulated Kit w/credit card-size I/R remote and wired instrument panel controllers, requires 6-Disc CD Changer PN 82202700, works w/any FM radio w/o CD changer controls	82202292*	0.8		55.00
CD CHANGERS — 4 DISC							
Concorde, Intrepid, LHS, 300M	2001	2000	Dash Mount 4 Disc CD changer. For use with radios with CD controls. Complete kit	82205893	0.4	6	470.00
Minivan (All)	2001	2001	Dash Mount 4 Disc CD changer. For use with radios with CD controls	82206633	0.4	6	470.00
Neon	2000	2000	Dash Mount 4 Disc CD changer. For use with radios with CD controls. Complete kit	82205811	0.4	6	470.00
	2001	2000	Dash Mount 4 Disc CD changer. For use with radios with CD controls. Complete kit	82206742	0.4	6	470.00
Sebring Sedan & Conv., Stratus Sedan	2001	2001	4 disc CD changer bezel (Black interior)	0SZ19XTMAB	D.I.Y.		6.00
	2001	2001	4 disc CD changer bezel (Blue interior)	0SZ19YBPAB	D.I.Y.		6.00
	2001	2001	4 disc CD changer bezel (Dark Brown interior)	0SZ19WL8AB	D.I.Y.		6.00
	2001	2001	4 disc CD changer bezel (Dark Quartz interior)	0SZ19XDVAB	D.I.Y.		6.00
	2001	2001	Dash Mount 4-Disc CD changer. For use with radios w/CD controls. Also order bezel	82206644	0.4	6	470.00
CD CHANGERS — 6 DISC							
Avenger, Sebring Coupe, Breeze, Cirrus, Stratus, Neon	2000	1995	Compact 6-Disc Changer (CCD Protocol), for use w/conventional mount radios w/CD controls or radios w/o CD controls, use FM-Modulated Kit PN 82202292 on radios w/o CD controls, additional Installation Kit may be required	82202700	D.I.Y.†	6	345.00
Cherokee, Wrangler	2001	1997	Compact 6-Disc Changer (CCD Protocol), for use w/conventional mount radios w/CD controls or radios w/o CD controls, use FM-Modulated Kit PN 82202292 on radios w/o CD controls, additional Installation Kit may be required	82202700	D.I.Y.†	6	345.00
Concorde, Intrepid, LHS, 300M	2000	1998	Compact 6-Disc Changer (J1850 Protocol), for use w/flush-mount radios w/CD changer controls, also order Installation Kit PN 82205307	82203465	D.I.Y.†	6	345.00
	2001	1993	Compact 6-Disc Changer (CCD Protocol), for use w/conventional mount radios w/CD controls or radios w/o CD controls, use FM-Modulated Kit PN 82202292 on radios w/o CD controls, additional Installation Kit may be required	82202700	D.I.Y.†	6	345.00
Dakota (All)	2001	2001	Compact 6-Disc Changer (J1850 Protocol), for use w/flush-mount radios w/CD changer controls, also order Installation Kit PN 82205307	82203465	D.I.Y.†	6	345.00

*DIN cables are not interchangeable with 82300930 kit.

† See installation kit for install times.

AUDIO PRODUCTS, CD CHANGERS (CONT.)

Vehicle Line	MYO	MYI	Application Remarks	Part Number	Instl Time	Group	Sugg Retail Price
CD CHANGERS — 6 DISC (CONT.)							
Dakota (All)	2001	1986	Compact 6-Disc Changer (CCD Protocol), for use w/conventional mount radios w/CD controls or radios w/o CD controls, use FM-Modulated Kit PN 82202292 on radios w/o CD controls, additional Installation Kit may be required	82202700	D.I.Y.*	6	345.00
Durango	2001	2001	Compact 6-Disc Changer (J1850 Protocol), for use w/flush-mount radios w/CD changer controls, also order Installation Kit PN 82205307	82203465	D.I.Y.*	6	345.00
Minivan (All)	2001	1996	Compact 6-Disc Changer (CCD Protocol), for use w/conventional mount radios w/CD controls or radios w/o CD controls, use FM-Modulated Kit PN 82202292 on radios w/o CD controls, additional Installation Kit may be required	82202700	D.I.Y.*	6	345.00
Neon	2001	2001	Compact 6-Disc Changer (J1850 Protocol), for use w/flush-mount radios w/CD changer controls, also order Installation Kit PN 82205307	82203465	D.I.Y.*	6	345.00
PT Cruiser	2001	2001	Compact 6-Disc Changer (CCD Protocol), for use w/conventional mount radios w/CD controls or radios w/o CD controls, use FM-Modulated Kit PN 82202292 on radios w/o CD controls, additional Installation Kit may be required	82202700	D.I.Y.*	6	345.00
Ram Pickup (All)	2001	1994	Compact 6-Disc Changer (CCD Protocol), for use w/conventional mount radios w/CD controls or radios w/o CD controls, use FM-Modulated Kit PN 82202292 on radios w/o CD controls, additional Installation Kit may be required	82202700	D.I.Y.*	6	345.00
Ram Van/Wagon	2001	1987	Compact 6-Disc Changer (CCD Protocol), for use with Conventional mount radios w/CD controls or radios w/o CD controls, use FM-Modulated Kit PN 82202292 on radios w/o CD controls, additional Installation Kit may be required	82202700	D.I.Y.*	6	345.00
Sebring Convertible	2000	1996	Compact 6-Disc Changer (CCD Protocol), for use w/conventional mount radios w/CD controls or radios w/o CD controls, use FM-Modulated Kit PN 82202292 on radios w/o CD controls, additional Installation Kit may be required	82202700	D.I.Y.*	6	345.00
Sebring Coupe, Stratus Coupe	2001	2001	Compact 6-Disc Changer (J1850 Protocol), for use w/flush-mount radios w/CD changer controls, also order Installation Kit PN 82205307	82203465	D.I.Y.*	6	345.00
	2001	2001	Compact 6-Disc Changer (CCD Protocol), for use Conventional mount radios w/CD controls or radios w/o CD controls, use FM-Modulated Kit PN 82202292 on radios w/o CD controls, additional Installation Kit may be required	82202700	D.I.Y.*	6	345.00
Viper	2001	1992	Compact 6-Disc Changer (CCD Protocol), for use w/conventional mount radios w/CD controls or radios w/o CD controls, use FM-Modulated Kit PN 82202292 on radios w/o CD controls, additional Installation Kit may be required	82202700	D.I.Y.*	6	345.00
CD CHANGERS — 10 DISC							
Grand Cherokee	2001	1999	Compact 10-Disc CD Changer (FM-Modulated), for use with radios w/o CD controls, includes wired credit-card sized remote controller. Install bracket (82204864) required. If vehicle has open bin order rear CD changer console	82204094 [†]	1.0	6	410.00
	2001	1999	Compact Disc 10-Disc (J1850 Protocol) for use w/CD controls radios, includes DIN cable and installation kit, if vehicle has open bin, also order rear CD Changer Console PN 82204624 Agate, PN 82204625 Camel, PN 82204626 Taupe	82204627	0.6	6	410.00
PT Cruiser	2001	2001	Underseat mount 10-Disc Changer - For use with CD Changer Control radios	82205892	0.6	6	410.00

*See installation kit for install times.

[†] NOTE: Warranty repairs on Ten-disc FM-Modulated CD Changer (PN82202636) or (PN82204094) are handled by calling (800) 529-1082.

AUDIO PRODUCTS, CD CHANGERS (CONT.)

Vehicle Line	MYO	MYI	Application Remarks	Part Number	Instl Time	Group	Sugg Retail Price
CD CHANGERS — 12 DISC							
Avenger, Sebring Coupe	2000	1998	Compact 12-Disc Changer (FM-Modulated), works w/any FM radio w/o CD changer controls, kit is complete w/mounting and installation hardware plus wired and infrared remote controllers	82204730	1.0	6	435.00
Breeze, Cirrus, Stratus, Neon	2000	1995	Compact 12-Disc Changer (FM-Modulated), works w/any FM radio w/o CD changer controls, kit is complete w/mounting and installation hardware plus wired and infrared remote controllers	82204730	1.0	6	435.00
Cherokee, Wrangler	2001	1997	Compact 12-Disc Changer (FM-Modulated), works w/any FM radio w/o CD changer controls, kit is complete w/mounting and installation hardware plus wired and infrared remote controllers	82204730	1.0	6	435.00
Concorde, Intrepid, LHS, 300M	2001	1993	Compact 12-Disc Changer (FM-Modulated), works w/any FM radio w/o CD changer controls, kit is complete w/mounting and installation hardware plus wired and infrared remote controllers	82204730	1.0	6	435.00
Durango	2001	1998	Compact 12-Disc Changer (FM-Modulated), works w/any FM radio w/o CD changer controls, kit is complete w/mounting and installation hardware plus wired and infrared remote controllers	82204730	1.0	6	435.00
Minivan (All)	2001	1996	Compact 12-Disc Changer (FM-Modulated), works w/any FM radio w/o CD changer controls, kit is complete w/mounting and installation hardware plus wired and infrared remote controllers	82204730	1.0	6	435.00
Ram Pickup (All)	2001	1994	Compact 12-Disc Changer (FM-Modulated), works w/any FM radio w/o CD changer controls, kit is complete w/mounting and installation hardware plus wired and infrared remote controllers	82204730	1.0	6	435.00
Ram Van/Wagon	2001	1987	Compact 12-Disc Changer (FM-Modulated), works w/any FM radio w/o CD changer controls, kit is complete w/mounting and installation hardware plus wired and infrared remote controllers	82204730	1.0	6	435.00
Sebring Convertible	2000	1996	Compact 12-Disc Changer (FM-Modulated), works w/any FM radio w/o CD changer controls, kit is complete w/mounting and installation hardware plus wired and infrared remote controllers	82204730	1.0	6	435.00

AUDIO PRODUCTS, RADIOS

RADIO MOUNTING APPLICATION

Year	Vehicle Line
2001/1997	Cherokee, Wrangler, B-Van, Ram

RADIO MOUNTING APPLICATION

Year	Vehicle Line
2000/1996	Avenger, Sebring

RADIO MOUNTING APPLICATION

Year	Vehicle Line
2000/1996	Breeze, Cirrus, Stratus, Sebring Convertible

RADIO MOUNTING APPLICATION

Year	Vehicle Line
2001/1998	Concorde, Intrepid, LHS, 300M
2001/1999	Grand Cherokee
2001/2001	Neon, PT Cruiser, Sebring/Stratus Coupe and Sedan, Sebring Convertible, Minivan, Durango, Dakota, Grand Cherokee

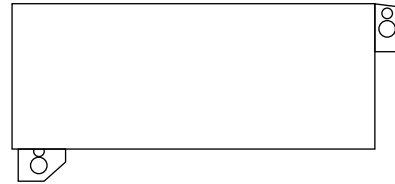

Mount Style 1

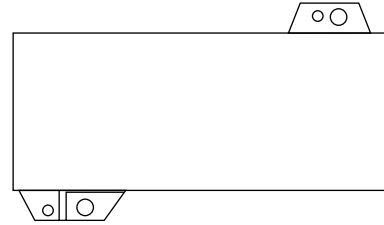

Conventional Mount Style 2

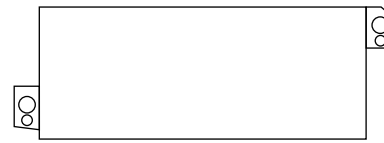

Conventional Mount Style 3

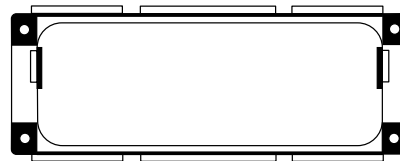

Flush Mount Style 4

MOPAR FEATURES

- Large radio makes controls easier to see and use
- "Perfect-fit mounting" eliminates squeaks and rattles
- Backlighting and vacuum fluorescent display match instrument panel exactly
- Electronically filtered to prevent damage to radio from voltage extremes and spikes
- Radio frequency emissions are kept at safe levels to avoid interference with vehicle electronic components
- Mopar Accessories are covered by either the 3-year/36,000-mile New Vehicle Limited Warranty, or the 12-month/12,000-mile Mopar Basic Limited Warranty, whichever is more favorable to the customer

COMPETITORS?*

- Does it have tiny, hard-to-see controls?
- Does it require an adapter plate, which may cause squeaks and rattles?
- Does the radio display match vehicle lighting? Is the LCD display hard to read?
- Will the radio become damaged from voltage extremes and spikes?
- Will the radio adversely affect vehicle's electronic controllers?
- Does the warranty compare?

*Check your market for your competitive situation.

AUDIO PRODUCTS, RADIOS (CONT.)



Sales Code (RAS)

AM/FM Stereo with Cassette Player (RAS)

- 40 watts of total power @ 3% THD*
- Separate bass/treble controls
- 10 AM/10 FM station presets
- Dolby B® Noise Reduction on tape
- Soft-touch electronic cassette with auto reverse
- Fast forward/rewind
- Bi-directional seek



Sales Code (RBS)

AM/FM Stereo with Cassette and Integrated CD Changer Controls (RBS)

- 66 watts of total power @ 3% THD*
- 12 AM/12 FM station presets
- Joystick balance/fader speaker control
- Dolby B® Noise Reduction on tape
- Soft-touch tape deck features automatic tape head cleaning, auto reverse, fast forward/rewind and music search
- Changer controls are on the radio face, featuring direct disc selection, fast forward/reverse and bi-directional seek



Sales Code (RBN) Flush-Mount

AM/FM Stereo with Cassette, Three-Band Graphic Equalizer and Integrated CD Changer Controls (RBN)

- 66 watts of total power @ 3% THD*
- 10 AM/10 FM station presets
- Seek-and-scan
- Soft-touch controls
- Cassette auto reverse
- Dolby B® Noise Reduction on tape
- Fast forward/rewind
- Music search
- Integrated changer controls on the radio face



Sales Code (RBN), Conventional Mount

AM/FM Stereo with Cassette, Five-Band Graphic Equalizer and Integrated CD Changer Controls (RBN)

- 66 watts of total power at 3% THD*
- 10 AM/10 FM station presets
- Seek-and-scan
- Joystick balance/fader speaker control
- Five-band graphic equalizer
- Soft-touch cassette controls
- Cassette auto reverse
- Dolby B Noise Reduction on tape
- Fast forward/rewind
- Music search
- Integrated CD changer controls on the radio face
- CD port



Sales Code (RBB)

AM/FM Stereo with Cassette, Three-Band Graphic Equalizer and Integrated CD Changer Controls (RBB)

- 66 watts of total power @ 3% THD*
- 10 AM/10 FM station presets
- Bi-directional seek
- Soft-touch controls
- Cassette auto reverse
- True fast forward/rewind
- Push in fader and balance controls
- Integrated changer controls on the radio face

*THD — Total Harmonic Distortion.

Dolby B is a registered trademark of Dolby Laboratories Licensing Corporation.

NOTE: All Mopar Radios are electronically tuned.

NOTE: Power ratings are commonly used rating standards. Ensure all comparisons are made on an equal basis.



Sales Code (RBR) Conventional-Mount

AM/FM Stereo with Integrated CD Player and Three-Band Graphic Equalizer (RBR)

- 66 watts of total power @ 3% THD*
- 10 AM/10 FM station presets
- Seek-and-scan
- Joystick balance/fader speaker control
- Three-band graphic equalizer
- CD Player features fast forward/reverse (scan), track access (skip), pause and elapsed time display



Sales Code (RBR) Flush-Mount

AM/FM Stereo with Integrated CD Player and Three-Band Graphic Equalizer and Integrated CD Changer Controls (RBR)

- 66 watts of total power @ 3% THD*
- 10 AM/10 FM station presets
- Seek-and-scan
- Balance/fader speaker control
- Three-band graphic equalizer
- CD Player features fast forward/reverse (scan), track access (skip), pause and elapsed time display



Sales Code (RBP) Flush-Mount



AM/FM Stereo with Cassette, CD and Integrated CD Changer Controls (RBP)

- 66 watts of total power @ 3% THD*
- 10 AM/10 FM station presets
- Seek-and-scan
- Balance/fader speaker control
- CD random play
- CD fast forward/reverse
- Cassette auto reverse
- Cassette fast forward/rewind



Sales Code (RAZ) Conventional-Mount

AM/FM Stereo with Cassette, CD Player and Three-Band Graphic Equalizer (RAZ)

- 62 watts of total power @ 3% THD*
- 10 AM/10 FM station presets
- Seek-and-scan
- Joystick balance/fader speaker control
- Three-band graphic equalizer
- Soft-touch cassette controls
- Cassette auto reverse, fast forward/rewind
- Dolby B® Noise Reduction on tape
- Music search
- CD player has optical sensing mechanism instead of mechanical to draw CD in
- CD playback features bi-directional track access (skip), fast forward/reverse, random play



Sales Code (RAZ) Flush-Mount

AM Stereo[†]/FM Stereo with Cassette, CD Player and Three-Band Graphic Equalizer (RAZ)

- 62 watts of total power @ 3% THD*
- 10 AM/10 FM station presets
- Seek-and-scan
- Balance/fader speaker control
- Three-band graphic equalizer
- Soft-touch cassette controls
- Cassette auto reverse, fast forward/rewind
- Dolby B® Noise Reduction on tape
- Music search
- CD player has optical sensing mechanism instead of mechanical to draw CD in
- CD playback features bi-directional track access (skip), fast forward/reverse, random play

* THD — Total Harmonic Distortion.

[†] Some AM stereo broadcasting may not be compatible with this radio.

Dolby B is a registered trademark of Dolby Laboratories Licensing Corporation.

NOTE: All Mopar Radios are electronically tuned.

NOTE: Power ratings are commonly used rating standards. Ensure all comparisons are made on an equal basis.



Sales Code (RBK)

AM/FM Stereo with Integrated CD Player and Two-Band Graphic Equalizer and CD Changer Controls (RBK)

- 66 watts of total power @ 3% THD*
- 10 AM/10 FM station presets
- Seek-and-scan
- Balance/fader speaker control
- Digital clock
- CD fast forward/reverse
- CD Seek-and-scan
- Elapsed time display



Sales Code (RBV)



AM/FM Stereo Radio with Two-Band Equalizer, Four-Disc CD Player and Integrated CD Changer Controls (RBV)

- 66 watts of total power @ 3% THD*
- 10 AM/10 FM station presets
- Single-load four-disc CD player
- Auto loudness
- Amber/Green lighting
- Flush-mount

* THD — Total Harmonic Distortion.

Dolby B is a registered trademark of Dolby Laboratories Licensing Corporation.

NOTE: All Mopar Radios are electronically tuned.

NOTE: Power ratings are commonly used rating standards. Ensure all comparisons are made on an equal basis.



Sales Code (RBZ)



AM/FM Stereo Four-Disc CD Radio with Integrated CD Changer controls (RBZ)

- Mopar exclusive flush-mount three-disc radio
- 66 watts of total power @ 3% THD*
- 10 AM/10 FM station presets
- Seek-and-scan
- Shuttle type changer
- Includes two Three-Disc magazines
- Random track selection/track scan-up
- Includes CD Changer controls

AUDIO PRODUCTS, RADIOS (CONT.)

Vehicle Line	MY0	MY1	Application Remarks	Part Number	Instl Time	Group	Sugg Retail Price
RAS — AM/FM STEREO WITH CASSETTE							
Breeze, Cirrus, Stratus	2000	1995	RAS AM/FM Stereo Radio with Cassette	56038937AB	0.3	2	315.00
	2000	1997	RAS AM/FM Stereo Radio with Cassette	04858558AE	0.3	2	315.00
Cherokee, Wrangler	2001	1997	RAS AM/FM Stereo Radio with Cassette	56038933AB*	0.3	2	315.00
Concorde, Intrepid, LHS, 300M	2001	1998	RAS AM/FM Stereo Cassette	56038931AB	0.3	2	315.00
Dakota (All)	2001	2001	RAS AM/FM Stereo Cassette	56038931AB	0.3	2	315.00
	2000	1987	RAS AM/FM Stereo Radio with Cassette	56038933AB	0.3	2	315.00
Durango	2000	1994	RAS AM/FM Stereo Radio with Cassette	56038933AB	0.3	2	315.00
Grand Cherokee	2001	1999	RAS AM/FM Stereo Cassette	56038931AB	0.3	2	315.00
Minivan (All)	2001	2001	RAS AM/FM Stereo Cassette	56038931AB	0.3	2	315.00
	2000	1996	RAS AM/FM Stereo Radio with Cassette	56038933AB	0.3	2	315.00
Neon	2001	2000	RAS AM/FM Stereo Cassette	56038931AB	0.3	2	315.00
	2000	2000	RAS AM/FM Stereo Radio with Cassette	04858583AF	0.3	2	315.00
Ram Pickup (All)	2001	1994	RAS AM/FM Stereo Radio with Cassette	56038933AB	0.3	2	315.00
Ram Van/Wagon	2001	1987	RAS AM/FM Stereo Radio with Cassette	56038933AB	0.3	2	315.00
RAZ — AM/FM STEREO WITH CASSETTE, CD & 3-BAND EQUALIZER							
Avenger, Sebring Coupe	2000	1996	RAZ AM Stereo/FM Stereo Radio w/Cassette, CD Player and 3-Band Graphic Equalizer; Premium	04704385AE [†]	0.3	2	695.00
Breeze, Cirrus, Stratus	2000	1995	RAZ AM Stereo/FM Stereo w/Cassette, CD, 3-Band Graphic Equalizer, Premium	82204878 [†]	0.3	2	695.00
	2000	1995	RAZ AM Stereo/FM Stereo Radio with Cassette and Compact Disc (Dual Media)	82206327 [†]	0.3	2	695.00
Cherokee	2001	1997	RAZ AM Stereo/FM Stereo w/Cassette, CD, w/3-Band Graphic Equalizer, Premium	04704383AH [†]	0.3	2	695.00
Concorde, Intrepid, LHS, 300M	2001	1998	RAZ — AM/FM Cassette and CD	04858540AH	0.3	2	695.00
	2000	1998	RAZ AM Stereo/FM Stereo w/Cassette, CD and 3-Band Graphic Equalizer, Premium, Flush Mount (J1850 Protocol)	04858540AG [†]	0.3	2	695.00
Dakota (All)	2001	2001	RAZ — AM/FM Cassette and CD	04858540AH	0.3	2	695.00
Dakota/Durango	2000	1986	RAZ AM Stereo/FM Stereo w/Cassette, CD, w/3-Band Graphic Equalizer, Premium	04704383AH [†]	0.3	2	695.00
Durango	2001	2001	RAZ — AM/FM Cassette and CD	04858540AH	0.3	2	695.00
Grand Cherokee	2001	1999	RAZ — AM/FM Cassette and CD	04858540AH	0.3	2	695.00
	2000	1999	RAZ AM Stereo/FM Stereo w/Cassette, CD and 3-Band Graphic Equalizer, Premium, Flush Mount (J1850 Protocol)	04858540AG [†]	0.3	2	695.00
Minivan (All)	2001	2001	RAZ — AM/FM Cassette and CD	04858540AH	0.3	2	695.00
	2000	1996	RAZ AM Stereo/FM Stereo w/Cassette, CD, w/3-Band Graphic Equalizer, Premium	04704383AH [†]	0.3	2	695.00
Neon	2001	2000	RAZ — AM/FM Cassette and CD	04858540AH	0.3	2	695.00
	2000	2000	RAZ AM Stereo/FM Stereo w/Cassette, CD and 3-Band Graphic Equalizer, Premium, Flush Mount (J1850 Protocol)	04858540AG [†]	0.3	2	695.00
PT Cruiser	2001	2001	RAZ — AM/FM Cassette and CD	04858540AH	0.3	2	695.00
	2001	2001	RAZ AM Stereo/FM Stereo w/Cassette, CD and 3-Band Graphic Equalizer, Premium, Flush Mount (J1850 Protocol)	04858540AG [†]	0.3	2	695.00

*Wrangler requires a four-speaker system with this audio system. Order optional Sound Bar or Sound Deck.

[†] Some AM stereo broadcasting may not be compatible with this radio.

AUDIO PRODUCTS, RADIOS (CONT.)

Vehicle Line	MY0	MY1	Application Remarks	Part Number	Instl Time	Group	Sugg Retail Price
RAZ — AM/FM STEREO WITH CASSETTE, CD & 3-BAND EQUALIZER (CONT.)							
Ram Pickup (All)	2001	1994	RAZ AM Stereo/FM Stereo w/Cassette, CD, w/3-Band Graphic Equalizer, Premium	04704383AH*	0.3	2	695.00
Ram Van/Wagon	2001	1986	RAZ AM Stereo/FM Stereo w/Cassette, CD, w/3-Band Graphic Equalizer, Premium	04704383AH*	0.3	2	695.00
Sebring Convertible	2000	1996	AM Stereo/FM Stereo Radio w/Cassette, CD Player and 3-Band Equalizer; Premium	04704384AE*	0.3	2	695.00
Sebring Coupe, Stratus Coupe	2001	2001	RAZ-AM/FM Radio w/Cassette and CD Player, 3-Band Equalizer	82206586*	0.3	2	695.00
Sebring Sedan & Conv., Stratus Sedan	2001	2001	RAZ — AM/FM Cassette and CD	04858540AH	0.3	2	695.00
RBB — AM/FM STEREO CASSETTE WITH INTEGRATED CD CHANGER CONTROLS							
Concorde, Intrepid, LHS, 300M	2001	1998	RBB AM/FM Stereo Radio w/Cassette and CD changer controls, Premium, flush-Mount (J1850 Protocol).	56038518AH	0.3	2	390.00
Dakota (All)	2001	2001	RBB AM/FM Stereo Radio w/Cassette and CD changer controls, Premium, flush-Mount (J1850 Protocol).	56038518AH	0.3	2	390.00
Durango	2001	2001	RBB AM/FM Stereo Radio w/Cassette and CD changer controls, Premium, flush-Mount (J1850 Protocol).	56038518AH	0.3	2	390.00
Grand Cherokee	2001	1999	RBB AM/FM Stereo Radio w/Cassette and CD changer controls, Premium, flush-Mount (J1850 Protocol).	56038518AH	0.3	2	390.00
Minivan (All)	2001	2001	RBB AM/FM Stereo Radio w/Cassette and CD changer controls, Premium, flush-Mount (J1850 Protocol).	56038518AH	0.3	2	390.00
Neon	2001	2000	RBB AM/FM Stereo Radio w/Cassette and CD changer controls, Premium, flush-Mount (J1850 Protocol).	56038518AH	0.3	2	390.00
PT Cruiser	2001	2001	RBB AM/FM Stereo Radio w/Cassette and CD changer controls, Premium, flush-mount(J1850) Protocol)	56038518AF	0.3	2	390.00
	2001	2001	RBB AM/FM Stereo Radio w/Cassette and CD changer controls, Premium, flush-Mount (J1850 Protocol).	56038518AH	0.3	2	390.00
Sebring Sedan & Conv., Stratus Sedan	2001	2001	RBB AM/FM Stereo Radio w/Cassette and CD changer controls, Premium, flush-Mount (J1850 Protocol).	56038518AH	0.3	2	390.00
RBK — AM/FM STEREO WITH CD & GRAPHIC EQUALIZER							
Concorde, Intrepid, LHS, 300M	2001	1993	RBK AM/FM Stereo w/CD Player, 2-Band Equalizer w/integrated CD Changer controls (flush style only)	56038567AF	0.3	2	460.00
Dakota (All)	2001	2001	RBK AM/FM Stereo w/CD Player, 2-Band Equalizer w/integrated CD Changer controls (flush style only)	56038567AF	0.3	2	460.00
Durango	2001	2001	RBK AM/FM Stereo w/CD Player, 2-Band Equalizer w/integrated CD Changer controls (flush style only)	56038567AF	0.3	2	460.00
Grand Cherokee	2001	1999	RBK AM/FM Stereo w/CD Player, 2-Band Equalizer w/integrated CD Changer controls (flush style only)	56038567AF	0.3	2	460.00
Minivan (All)	2001	2001	RBK AM/FM Stereo w/CD Player, 2-Band Equalizer w/integrated CD Changer controls (flush style only)	56038567AF	0.3	2	460.00
Neon	2001	1995	RBK AM/FM Stereo w/CD Player, 2-Band Equalizer w/integrated CD Changer controls (flush style only)	56038567AF	0.3	2	460.00
Sebring Sedan & Conv., Stratus Sedan, PT Cruiser	2001	2001	RBK AM/FM Stereo w/CD Player, 2-Band Equalizer w/integrated CD Changer controls (flush style only)	56038567AF	0.3	2	460.00

*Some AM stereo broadcasting may not be compatible with this radio.

AUDIO PRODUCTS, RADIOS (CONT.)

Vehicle Line	MY0	MY1	Application Remarks	Part Number	Instl Time	Group	Sugg Retail Price
RBN — AM/FM STEREO WITH CASSETTE & INTEGRATED CD CHANGER CONTROLS							
Avenger, Sebring Coupe	2000	1996	RBN AM/FM Stereo Radio w/Cassette, 5-Band Equalizer, CD changer controls, Premium	82204229	0.3	2	420.00
Cherokee, Wrangler	2001	1997	RBN AM/FM Stereo Radio with Cassette, 5-Band Equalizer and CD Changer Controls	04704386AD*	0.3	2	420.00
Concorde, Intrepid, LHS, 300M	2000	1998	RBN AM/FM Stereo w/Cassette, 3-Band Graphic Equalizer and CD changer controls, Premium, Flush-Mount (J1850 Protocol)	04858584AH	0.3	2	420.00
Dakota/Durango	2000	1986	RBN AM/FM Stereo Radio w/Cassette, 5-Band Equalizer and CD Changer Controls	04704386AD	0.3	2	420.00
Grand Cherokee	2000	1999	RBN AM/FM Stereo w/Cassette, 3-Band Graphic Equalizer and CD changer controls, Premium, Flush-Mount (J1850 Protocol)	04858584AH	0.3	2	420.00
Minivan (All)	2000	1996	RBN AM/FM Stereo Radio with Cassette, 5-Band Equalizer and CD Changer Controls	04704386AE	0.3	2	420.00
Neon	2000	2000	RBN AM/FM Stereo w/Cassette, 3-Band Graphic Equalizer and CD changer controls, Premium, Flush-Mount (J1850 Protocol)	04858584AH	0.3	2	420.00
PT Cruiser	2001	2001	RBN AM/FM Stereo w/Cassette, 3-Band Graphic Equalizer and CD changer controls, Premium, Flush-Mount (J1850 Protocol)	04858584AH	0.3	2	420.00
Ram Pickup (All)	2001	1994	RBN AM/FM Stereo Radio with Cassette, 5-Band Equalizer and CD Changer Controls	04704386AD	0.3	2	420.00
Ram Van/Wagon, Dakota (All)	2001	1986	RBN AM/FM Stereo Radio with Cassette, 5-Band Equalizer and CD Changer Controls	04704386AD	0.3	2	420.00
Sebring Coupe, Stratus Coupe	2001	2001	RBN AM/FM Radio w/Cassette and CD Changer controls	MR459822	0.3		420.00
RBP — AM/FM STEREO WITH CASSETTE, CD AND INTEGRATED CD CHANGER CONTROLS							
Concorde, Intrepid, LHS, 300M	2000	1998	RBP AM/FM Stereo w/Cassette, CD and CD changer controls, Flush Mount	82205787	0.3	2	650.00
	2001	1998	AM/FM Stereo Radio w/Cassette, CD Player and CD changer controls, Flush Mount	56038623AF	0.3	2	650.00
Dakota (All)	2001	2001	AM/FM Stereo Radio w/Cassette, CD Player and CD changer controls, Flush Mount	56038623AF	0.3	2	650.00
Durango	2001	2001	AM/FM Stereo Radio w/Cassette, CD Player and CD changer controls, Flush Mount	56038623AF	0.3	2	650.00
Grand Cherokee	2000	1999	RBP AM/FM Stereo w/Cassette, CD and CD changer controls, Flush Mount	82205787	0.3	2	650.00
	2001	1999	AM/FM Stereo Radio w/Cassette, CD Player and CD changer controls, Flush Mount	56038623AF	0.3	2	650.00
Minivan (All)	2001	2001	AM/FM Stereo Radio w/Cassette, CD Player and CD changer controls, Flush Mount	56038623AF	0.3	2	650.00
Neon	2000	2000	RBP AM/FM Stereo w/Cassette, CD and CD changer controls, Flush Mount	82205787	0.3	2	650.00
	2001	2000	AM/FM Stereo Radio w/Cassette, CD Player and CD changer controls, Flush Mount	56038623AF	0.3	2	650.00
PT Cruiser	2001	2001	RBP AM/FM Stereo w/Cassette, CD and CD changer controls, Flush Mount	82205787	0.3	2	650.00
	2001	2001	AM/FM Stereo Radio w/Cassette, CD Player and CD changer controls, Flush Mount	56038623AF	0.3	2	650.00
Sebring Sedan & Conv., Stratus Sedan	2001	2001	AM/FM Stereo Radio w/Cassette, CD Player and CD changer controls, Flush Mount	56038623AF	0.3	2	650.00

*Wrangler requires a four-speaker system with this audio system. Order optional Sound Bar or Sound Deck.

AUDIO PRODUCTS, RADIOS (CONT.)

Vehicle Line	MY0	MY1	Application Remarks	Part Number	Instl Time	Group	Sugg Retail Price
RBR — AM/FM STEREO WITH CD & GRAPHIC EQUALIZER							
Breeze, Cirrus, Stratus	2000	1996	RBR AM/FM Premium Stereo Radio w/CD Player and 3-Band Equalizer	04858555AE	0.3	2	640.00
Cherokee, Wrangler	2001	1997	RBR AM/FM Premium Stereo Radio w/CD Player and 3-Band Equalizer	04704373AE*	0.3	2	640.00
Concorde, Intrepid, LHS, 300M	2000	1998	RBR AM/FM Stereo Radio w/CD Player and 3-Band Equalizer, Premium, Flush-Mount (J1850 Protocol), includes integrated CD changer controls	04858585AG	0.3	2	640.00
Dakota (All)	2000	1986	RBR AM/FM Premium Stereo Radio w/CD Player and 3-Band Equalizer	04704373AE	0.3	2	640.00
Durango	2000	1986	RBR AM/FM Premium Stereo Radio w/CD Player and 3-Band Equalizer	04704373AE	0.3	2	640.00
Grand Cherokee	2000	1999	RBR AM/FM Stereo Radio w/CD Player and 3-Band Equalizer, Premium, Flush-Mount (J1850 Protocol), includes integrated CD changer controls	04858585AG	0.3	2	640.00
Minivan (All)	2000	1996	RBR AM/FM Premium Stereo Radio w/CD Player and 3-Band Equalizer	04704373AE	0.3	2	640.00
Neon	2000	2000	RBR AM/FM Stereo Radio w/CD Player and 3-Band Equalizer, Premium, Flush-Mount (J1850 Protocol), includes integrated CD changer controls	04858585AG	0.3	2	640.00
PT Cruiser	2001	2001	AM/FM Stereo w/ CD changer controls, 3-Band Equalizer	04858585AF	0.3		640.00
	2001	2001	RBR AM/FM Stereo Radio w/CD Player and 3-Band Equalizer, Premium, Flush-Mount (J1850 Protocol), includes integrated CD changer controls	04858585AG	0.3	2	640.00
Ram Pickup (All)	2001	1994	RBR AM/FM Premium Stereo Radio w/CD Player and 3-Band Equalizer	04704373AE	0.3	2	640.00
Ram Van/Wagon	2001	1986	RBR AM/FM Premium Stereo Radio w/CD Player and 3-Band Equalizer	04704373AE	0.3	2	640.00
Sebring Convertible	2000	1996	RBR AM/FM Stereo Radio w/CD Player and 3-Band Equalizer, Premium, Flush-Mount (J1850 Protocol), includes integrated CD changer controls	04704376AC	0.3	2	640.00
RBS — AM/FM STEREO WITH CASSETTE AND CD CHANGER CONTROLS							
Breeze, Cirrus, Stratus	2000	2000	RBS AM/FM Stereo Radio w/Cassette, CD changer controls	04704377AE	0.3	2	420.00
Sebring Convertible	2000	1999	RBS AM/FM Stereo Radio with Cassette and Integrated CD Changer Controls	04704380AE	0.3	2	420.00
RBV — AM/FM STEREO WITH 4-DISC CD CHANGER							
Dakota (All)	2001	2001	RBV AM/FM Stereo, 3 band Equalizer with a single load 4-disc CD changer and CD changer controls	82206588	0.3	2	650.00
Durango	2001	2001	RBV AM/FM Stereo, 3 band Equalizer with a single load 4-disc CD changer and CD changer controls	82206588	0.3	2	650.00
Minivan (All)	2001	2001	RBV AM/FM Stereo, 3 band Equalizer with a single load 4-disc CD changer and CD changer controls	82206588	0.3	2	650.00
Sebring Sedan & Conv., Stratus Sedan, Concorde, Intrepid, LHS, 300M	2001	2001	RBV AM/FM Stereo, 3 band Equalizer with a single load 4-disc CD changer and CD changer controls	82206588	0.3	2	650.00
Sebring Coupe, Stratus Coupe	2001	2001	RBV AM/FM Stereo, 3 band Equalizer with a single load 4-disc CD changer and CD changer controls	82206587	0.3	2	650.00

*Wrangler requires a four-speaker system with this audio system. Order optional Sound Bar or Sound Deck.

AUDIO PRODUCTS, RADIOS (CONT.)

Vehicle Line	MYO	MYI	Application Remarks	Part Number	Instl Time	Group	Sugg Retail Price
RBZ — AM/FM STEREO WITH 3-DISC CD CHANGER							
Concorde, Intrepid, LHS, 300M	2001	1998	RBZ AM/FM Stereo 3-Disc Radio w/CD changer controls, Includes two 3-disc magazines	82204810*	0.3	2	650.00
Dakota (All)	2001	2001	RBZ AM/FM Stereo 3-Disc Radio w/CD changer controls, Includes two 3-disc magazines	82204810*	0.3	2	650.00
Durango	2001	2001	RBZ AM/FM Stereo 3-Disc Radio w/CD changer controls, Includes two 3-disc magazines	82204810*	0.3	2	650.00
Minivan (All)	2001	2001	RBZ AM/FM Stereo 3-Disc Radio w/CD changer controls, Includes two 3-disc magazines	82204810*	0.3	2	650.00
Sebring Sedan & Conv., Stratus Sedan, PT Cruiser	2001	2001	RBZ AM/FM Stereo 3-Disc Radio w/CD changer controls, Includes two 3-disc magazines	82204810*	0.3	2	650.00
REPLACEMENT PARTS							
Avenger, Sebring Coupe, Breeze, Cirrus, Stratus, Sebring Convertible, Viper	2001	1992	Radio Mounting Hardware, includes 2 mounting screws, 1 ground clip w/screws	82300966	D.I.Y.		1.25
	2001	1992	Radio Databus Connector Package (CCD), 2-way connect or connector plugs directly into radio	82202908	0.2		11.25
Cherokee, Grand Cherokee, Wrangler	2001	1987	Radio Databus Connector Package, includes 2 7-way radio connectors (1 black, 1 gray) w/unterminated vehicle side wiring	04720928	0.3		19.00
Cherokee, Wrangler	2001	1997	Radio Mounting Hardware, includes 2 mounting screws, 1 ground clip w/screws	82300966	D.I.Y.		1.25
	2001	1997	Radio Databus Connector Package (CCD), 2-way connect or connector plugs directly into radio	82202908	0.2		11.25
Durango, Ram Pickup	2001	1994	Radio Mounting Hardware, includes 2 mounting screws, 1 ground clip w/screws	82300966	D.I.Y.		1.25
	2001	1994	Radio Databus Connector Package (CCD), 2-way connect or connector plugs directly into radio	82202908	0.2		11.25
	2001	1987	Radio Databus Connector Package, includes 2 7-way radio connectors (1 black, 1 gray) w/unterminated vehicle side wiring	04720928	0.3		19.00
Minivan (All)	2000	1996	Radio Mounting Hardware, includes 2 mounting screws, 1 ground clip w/screws	82300966	D.I.Y.		1.25
	2000	1996	Radio Databus Connector Package (CCD), 2-way connect or connector plugs directly into radio	82202908	0.2		11.25
	2001	1987	Radio Databus Connector Package, includes 2 7-way radio connectors (1 black, 1 gray) w/unterminated vehicle side wiring	04720928	0.3		19.00
Passenger Cars (All)	2001	1987	Radio Databus Connector Package, includes 2 7-way radio connectors (1 black, 1 gray) w/unterminated vehicle side wiring	04720928	0.3		19.00
Ram Van/Wagon	2000	1987	Radio Mounting Hardware, includes 2 mounting screws, 1 ground clip w/screws	82300966	D.I.Y.		1.25
Ram Van/Wagon, Dakota (All)	2001	1987	Radio Databus Connector Package (CCD), 2-way connect or connector plugs directly into radio	82202908	0.2		11.25
	2001	1987	Radio Databus Connector Package, includes 2 7-way radio connectors (1 black, 1 gray) w/unterminated vehicle side wiring	04720928	0.3		19.00

*Not for use with audio sales code "RCE"/Infiniti System, or vehicles with steering wheel radio controls.

AUDIO PRODUCTS, SOUND BARS



Wrangler Sound Bar



Use with Soft Top or Hardtop

MOPAR FEATURES	COMPETITORS?*
<ul style="list-style-type: none"> • Sound-balanced crossover network system with premium speakers for superior sound • Contains two dual-cone speakers for high-fidelity sound reproduction • Includes center dome light • Available for use on soft top and hardtop models • Available in colors to match vehicle interiors • Won't interfere with seat belt operation • Entire speaker system is water-resistant and covered with the same vinyl material as the Sports Bar • Mopar Accessories are covered by either the 3-year/36,000-mile New Vehicle Limited Warranty, or the 12-month/12,000-mile Mopar Basic Limited Warranty, whichever is more favorable to the customer 	<ul style="list-style-type: none"> • Is the crossover network system balanced? Is the sound quality compromised? • Do their sound bars come only in one color? • Are speakers permanently mounted? Will they interfere with seat belts? • Does the warranty compare?

*Check your market for your competitive situation.

Vehicle Line	MYO	MYI	Application Remarks	Part Number	Instl Time	Group	Sugg Retail Price
SOUND BARS							
Wrangler	2001	1997	Speaker Kit pair, mounts to instrument panel	82206627	0.3	2	45.00
	2001	1997	Sound Bar, Black w/map light	82204646*	0.5	2	260.00
	2001	1999	Sound Bar, Camel Tan w/map light	82204647*	0.5	2	260.00

*Overhead speaker system requires upgraded system from two speakers RAL (front or rear fader control needed).

AUDIO PRODUCTS, SUBWOOFER



Wrangler Subwoofer



Wrangler Subwoofer (from front)



PT Cruiser Subwoofer



Cherokee Subwoofer



Grand Cherokee Subwoofer

MOPAR FEATURES

- Exclusive Jeep® logo on Wrangler
- Stylish speaker enclosure matches interior trim color and graining
- Upgraded instrument panel midrange speakers for stereo imaging (Wrangler only)
- Custom plug-in wiring matched to harness (Wrangler only)
- Easy listening, even with top down at freeway speeds
- Fold down (Wrangler) or removable (Grand Cherokee) for more cargo room
- Tuned acoustical enclosure for superior sound performance
- Includes two tweeters to ensure bright, crisp sound
- 50-watt amp powers 8" subwoofer for added bass response
- Mopar Accessories are covered by either the 3-year/36,000-mile New Vehicle Limited Warranty, or the 12-month/12,000-mile Mopar Basic Limited Warranty, whichever is more favorable to the customer

COMPETITORS?*

- Jeep logo is exclusive to Mopar, Jeep and DaimlerChrysler Corporation
- Does it match the interior?
- Is it easy to hear the music with the top down?
- Does it take up rear cargo area space?
- Does it have tuned acoustical enclosure for superior sound performance?
- Does the warranty compare?

*Check your market for your competitive situation.

AUDIO PRODUCTS, SUBWOOFER (CONT.)

Vehicle Line	MY0	MY1	Application Remarks	Part Number	Instl Time	Group	Sugg Retail Price
SUBWOOFERS							
Cherokee	2001	1997	Mounted in rear cargo spare tire hub under spare tire cover, 8" woofer and 50-watt amplifier	82204834	0.5		275.00
Grand Cherokee	2001	1999	Agate, subwoofer/storage custom enclosure contains an 8" woofer and a 50-watt amplifier, mounts in rear cargo behind rear seat and contains a netted storage compartment	82205263	0.5		400.00
	2001	1999	Camel, subwoofer/storage custom enclosure contains an 8" woofer and a 50-watt amplifier, mounts in rear cargo behind rear seat and contains a netted storage compartment	82205264	0.5		400.00
	2001	1999	Dark Taupe, subwoofer/storage customer enclosure contains an 8" woofer and a 50-watt amplifier, mounts in rear cargo behind rear seat and contains a netted storage compartment	82205265	0.5		400.00
PT Cruiser	2001	2001	50-watt amplifier powers 8.0" subwoofer, housed in left-rear trim panel, complete kit, compatible w/any radio	82205894	0.5		400.00
Wrangler	2000	1997	Wiring Adapter Subwoofer for vehicles with 2-speaker radio, no fader control	82204653	D.I.Y.		17.00
	2001	2001	Console, Agate, w/lock, w/Subwoofer speaker and wiring	82206345	1.0		315.00
	2001	2001	Console, Camel, w/lock, w/Subwoofer speaker and wiring	82206344	1.0		315.00
	2001	1999	Agate, 50-watt amplified 8" woofer enclosed in attractive enclosure with two tweeters. Also includes replacement instrument panel mid-range speakers	82204808*	1.0		345.00
	2001	1999	Camel Tan, 50-watt amplified 8" woofer enclosed in attractive enclosure with two tweeters. Also includes replacement instrument panel mid-range speakers	82204809*	1.0		345.00

*NOTE: Wrangler subwoofer cannot be installed with an Add-A-Trunk (either Mopar or OE style).

AUXILIARY TRANSMISSION COOLERS

MOPAR FEATURES	COMPETITORS?*
<ul style="list-style-type: none"> • Greatly extend the life of the transmission by reducing high temperatures associated with off-road or heavy-duty operations • Required for snowplowing and heavy-duty trailer towing • Complete kit • Mopar Accessories are covered by either the 3-year/36,000-mile New Vehicle Limited Warranty or the 12-month/12,000-mile Mopar Basic Limited Warranty, whichever is more favorable to the customer 	<ul style="list-style-type: none"> • Does the warranty compare?

*Check your market for your competitive situation.

INSTALLATION:

Same as original equipment

Vehicle Line	MYO	MYI	Application Remarks	Part Number	Instl Time	Group	Sugg Retail Price
AUXILIARY TRANSMISSION COOLERS							
Cherokee	2001	1996	Use w/4.0L (Power Tech I-6 cyl) engine	82204191	1.0	T	60.00
Dakota (All)	2001	2000	Use w/3.9L engine	82205677	0.6	T	183.00
	2001	2000	Use w/4.7L, 5.2L, and 5.9L engines - includes HD radiator	82205678	3.0	T	375.00
Durango	2001	2000	Use w/4.7L, 5.2L, and 5.9L engines - includes HD radiator	82205678	3.0	T	375.00
Grand Cherokee	2000	1999	Power Steering Cooler, Required for Trailer Towing if vehicle is not equipped with OE Trailer Tow Package	82204498	0.5	T	45.00
Minivan (All)	2000	1996	Transmission Oil Cooler Kit	05003119AA	1.3	T	95.00
Ram Pickup (All)	2001	1994	5.2L gas engine, automatic transmission	82401195	1.0	T	129.00
	2001	1994	5.9L gas engine, automatic transmission	82401196	1.0	T	198.00

BED EXTENDER



Bed Extender (shown on Dakota)

MOPAR FEATURES	COMPETITORS?*
<ul style="list-style-type: none"> • Helps secure cargo inside the bed • Flips over to increase cargo carrying capacity • Grocery/storage bag hooks are built in for added convenience • Easily installed • No tools required for removal • "Push lock" design locks organizer to tailgate, helps prevent rattling over bumps • Mopar Accessories are covered by either the 3-year/36,000-mile New Vehicle Limited Warranty or the 12-month/12,000-mile Mopar Basic Limited Warranty, whichever is more favorable to the customer 	<ul style="list-style-type: none"> • Does it have grocery/storage bag hooks? • Does it require tools to remove? • Are straps required to hold extender in place? • Does it have a lock-down mechanism, or can it rattle over bumps? • Does the warranty compare?

*Check your market for your competitive situation.

Vehicle Line	MYO	MYI	Application Remarks	Part Number	Instl Time	Group	Sugg Retail Price
BED EXTENDER							
Dakota (All)	2001	1997	Bed Extender attaches to the rear of the bed and pivots in or out of the bed	82205461	0.8		235.00
Ram (All)	2001	1994	Bed Extender attaches to the rear of the bed and pivots in or out of the bed	82205461*	0.8		235.00

*Available 1/1/01.

BED LIGHTS & POWER OUTLET



MOPAR FEATURES

- Weather resistant light and power outlet
- Neatly fits in premolded spot in bedliners
- Mopar Accessories are covered by either the 3-year/36,000-mile New Vehicle Limited Warranty or the 12-month/12,000-mile Mopar Basic Limited Warranty, whichever is more favorable to the customer

COMPETITORS?*

- Does it have a weather resistant light and power outlet?
- Does it fit easily into bedliner?
- Does the warranty compare?

*Check your market for your competitive situation.

Vehicle Line	MYO	MYI	Application Remarks	Part Number	Instl Time	Group	Sugg Retail Price
BEDLINERS — BED LIGHTS & POWER OUTLET							
Dakota (All)	2001	1998	Bed Light and Power Outlet	82203237	0.8		118.00
Ram Pickup (All)	2001	1998	Bed Light and Power Outlet	82203237	0.8		118.00

BEDLINERS

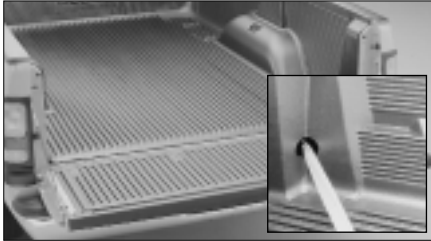

Over-The-Rail Bedliner (shown on Ram Pickup)
Inset: Tie-down access



Under-The-Rail Bedliner
(shown on Ram Pickup)

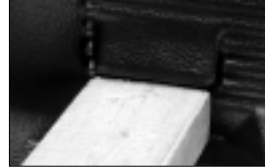

2 x 4 holder



Over-The-Rail Bedliner
(shown on Dakota)



Under-The-Rail Bedliner
(shown on Dakota)

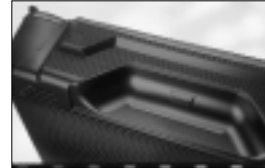

New Adhesive Strip to
Reduce Noise



Includes Tailgate Cover

MOPAR FEATURES

- Dodge logo (exclusive)
- Ribbed for easier drainage
- Skid-resistant material (under-the-rail)
- No-drill installation
- Wraps over the bulkhead and resists warping
- Access to tie-downs
- Foam tape reduces noise and unique floor design prevents floor lift; helps seal out dirt and rocks
- Vertical and horizontal board supports for dividing loads; board supports are fully supported by the truck box
- Convenient cup holders in tailgate cover
- Protect the truck bed from scratches, dents and chips; impact-resistant
- Made of a blend of rubber and high-density polyethylene (under-the-rail)
- Personal-use buyers prefer the under-the-rail design for its skid-resistant feature
- Work-use buyers like the over-the-rail style for rail protection and sliding ease when loading and unloading
- Heavy-duty liners are 30 percent thicker, feature anti-skid on both sides and provisions to cut out for a fifth-wheel hitch
- Light and power outlet weather resistant
- Included shielded cable
- Excellent for Tonneau Cover
- Mopar Accessories are covered by either the 3-year/36,000-mile New Vehicle Limited Warranty or the 12-month/12,000-mile Mopar Basic Limited Warranty, whichever is more favorable to the customer

COMPETITORS?*

- Dodge logo is exclusive to Mopar, Dodge and DaimlerChrysler
- Is it a flat construction that may trap moisture?
- Mopar's skid-resistant formula is patented
- Does it require drilling?
- Does it have screw-in fasteners at the bulkhead? Will it warp?
- Are tie-downs covered?
- Does it have cup holders?
- Does it trap air at highway speeds?
- Does it collect dirt or rocks and consequently rattles?
- Are board supports available? If yes, are they supported by the truck box?
- Does the floor design trap water?
- Is the Bedliner as thick as Mopar's?
- Does the warranty compare?

*Check your market for your competitive situation.

To order, please call (800) OE LINER.

INSTALLATION:

No drilling required

BEDLINERS (CONT.)

Vehicle Line	MYO	MYI	Application Remarks	Part Number	Instl Time	Group	Sugg Retail Price
BED LINERS — HD COMMERCIAL*							
Ram Pickup w/6.5 Ft. Bed	2001	1995	Heavy-Duty, Under-The-Rail, 6.5 ft. Bed	82205008	0.3	J	300.00
Ram Pickup w/8.0 Ft. Bed	2001	1995	Heavy-Duty, Under-The-Rail, 8.0 ft. Bed	82205009	0.3	J	300.00
BED LINERS — OVER RAIL*							
Dakota Regular & Club Cab	2001	1998	Over-The-Rail, 6.5 ft. Bed	82203896	0.3	J	250.00
Ram Pickup w/6.5 Ft. Bed	2001	1995	Over-The-Rail, 6.5 ft. Bed	82206365	0.3	J	250.00
Ram Pickup w/8.0 Ft. Bed	2001	1995	Over-The-Rail, 8.0 ft. Bed	82206366	0.3	J	250.00
BED LINERS — UNDER RAIL*							
Dakota Quad Cab	2001	2000	Under-The-Rail, Quad Cab, 5.3 ft. Bed	82205028	0.3	J	250.00
Ram Pickup w/6.5 Ft. Bed	2001	1995	Under-The-Rail, 6.5 ft. Bed	82203890	0.3	J	250.00
	2001	1995	Under-The-Rail, 6.5 ft. Bed	82206363	0.3	J	250.00
Ram Pickup w/8.0 Ft. Bed	2001	1995	Under-The-Rail, 8.0 ft. Bed	82206364	0.3	J	250.00

*To order, please call 1-800-OE Liner to place an order.

BED MATS/BED TRAYS



Bed Mat (shown on Ram Pickup)



Bed Mat (shown on Dakota)



Exclusive Dodge logo

MOPAR FEATURES

Bed Tray

- Made of a blend of rubber and high-density polyethylene
- Bottom surface is specially designed to help prevent mildew and corrosion; oil- and grease-resistant
- Raised Dodge logo adds personalized style
- Easily removed for cleaning
- Precut to truck bed
- Molded, raised ribs help reduce cargo shifting
- Makes loading and unloading easier
- Aid drainage
- Cover the full length of the bed and tailgate to help guard against scratches and dents
- Insulate the bed from vibration and noise

Bed Mat

- Made of half-inch thick, nylon-reinforced rubber, mat protects truck bed floor and tailgate from scratches
- Mat is easy to remove for cleaning and features a molded-in Dodge logo
- Includes tailgate cover
- Mopar Accessories are covered by either the 3-year/36,000-mile New Vehicle Limited Warranty or the 12-month/12,000-mile Mopar Basic Limited Warranty, whichever is more favorable to the customer

COMPETITORS?*

- Is it made of compression-molded rubber, which may crack or tear?
- Is it a flat construction that may trap moisture?
- Dodge logo is exclusive to Mopar, Dodge and DaimlerChrysler Corporation
- Is it a universal fit? Does it require cutting?
- Does the warranty compare?

*Check your market for your competitive situation.

INSTALLATION:

Installs in minutes

Vehicle Line	MYO	MYI	Application Remarks	Part Number	Instl Time	Group	Sugg Retail Price
BED MATS							
Dakota Quad Cab	2001	2000	5.3 ft. bed, Quad Cab, includes Tailgate Cover	82204607	0.3	T	155.00
Dakota Regular & Club Cab	2001	1988	6.5 ft. bed, includes Tailgate Cover	82204301	0.3	T	155.00
Ram Pickup (All)	2001	1994	6.5 ft. bed, includes Tailgate Cover	82401325	0.3	T	155.00
	2001	1994	8.0 ft. bed, includes Tailgate Cover	82401326	0.3	T	169.00

BED MATS/BED TRAYS (CONT.)

Vehicle Line	MYO	MYI	Application Remarks	Part Number	Instl Time	Group	Sugg Retail Price
BED TRAYS							
Dakota Regular & Club Cab	2001	1997	6.5 ft. bed, includes Tailgate Cover	82205003	D.I.Y.	T	188.00
Ram Pickup w/8.0 ft Bed	2001	1994	8.0 ft. bed, includes Tailgate Cover	82205006	D.I.Y.	T	188.00
Ram Pickup w/6.5 Ft. Bed	2001	1994	6.5 ft. bed, includes Tailgate Cover	82205005	D.I.Y.	T	188.00

BED RAIL PROTECTORS

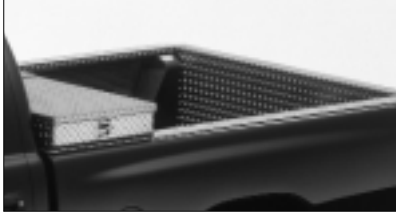

Bed Rail Protectors (shown on Ram Pickup)



Bed Rail Protectors (shown on Dakota)

MOPAR FEATURES	COMPETITORS?*
<ul style="list-style-type: none"> • Anodized aluminum resists corrosion, pitting, peeling and is scratch resistant • Adhesive gaskets between Bed Rail Protector and vehicle protects bed from damage and rust • Specifically designed to match other Mopar Accessories • Trimmed to match contour of truck bed • Mopar Accessories are covered by either the 3-year/36,000-mile New Vehicle Limited Warranty or the 12-month/12,000-mile Mopar Basic Limited Warranty, whichever is more favorable to the customer 	<ul style="list-style-type: none"> • Is it anodized? Will it pit or corrode? • Are gaskets included? • Do they provide a uniform look when used with other accessories? • Does the warranty compare?

*Check your market for your competitive situation.

INSTALLATION:

Features rust-resistant self-drilling/sealing screws for easy assembly

BED RAIL PROTECTORS (CONT.)

Vehicle Line	MYO	MYI	Application Remarks	Part Number	Instl Time	Group	Sugg Retail Price
BED RAIL PROTECTORS*							
Dakota Regular & Club Cab	2001	1997	Aluminum, diamond plate bed front rail, top edge, use w/o bedliner	82203250	0.2	T	49.00
	2001	1997	Aluminum, diamond plate tailgate top edge, use w/o bedliner	82203157	0.2	T	49.00
	2001	1997	Aluminum, diamond plate tailgate front face, use w/o bedliner	82203251	0.2	T	162.00
	2001	1997	Aluminum, diamond plate 6.5' side rail, top edge, 1 pair, use w/o bedliner	82203248	0.2	T	158.00
	2000	1997	Bright Aluminum, smooth surface, 4 piece top edge set (front rail top edge, tailgate top edge, pair of side rails) 6.5' bed, use w/o bedliner	82204106	0.5	T	230.00
	2000	1997	Black Aluminum, smooth finish, 4 piece top edge set (front rail top edge, tailgate top edge, pair of side rails) 6.5' bed, use w/o bedliner	82204111	0.5	T	250.00
Dakota Quad Cab	2001	2000	Aluminum, diamond plate, 5.3' side rail, top edge, 1 pair, use w/o bedliner	82206911	0.2	T	158.00
Ram Pickup w/6.5' Bed	2001	1994	Aluminum, diamond plate bed front rail, top edge, use w/o bedliner	82203595	0.2	T	49.00
	2001	1994	Aluminum, diamond plate tailgate top edge, use w/o bedliner	82203596	0.3	T	49.00
	2001	1994	Aluminum, diamond plate tailgate front face, use w/o bedliner	82203597	0.2	T	162.00
	2001	1994	Aluminum, diamond plate 6.5' side rail, top edge, 1 pair, use w/o bedliner	82203598	0.2	T	158.00
	2001	1994	Bright Aluminum, smooth finish, 4 piece top edge set 6.5' bed (front rail top edge, tailgate top edge, pair of side rails) 6.5' bed, use w/o bedliner	82204107	0.5	T	235.00
	2001	1994	Black Aluminum, smooth finish, 4 piece top edge set 6.5' bed (front rail top edge, tailgate top edge, pair of side rails) 6.5' bed, use w/o bedliner	82204112	0.5	T	250.00
Ram Pickup w/8.0 Bed	2001	1994	Aluminum, diamond plate bed front rail, top edge, use w/o bedliner	82203595	0.2	T	49.00
	2001	1994	Aluminum, diamond plate tailgate top edge, use w/o bedliner	82203596	0.3	T	49.00
	2001	1994	Aluminum, diamond plate tailgate front face, use w/o bedliner	82203597	0.2	T	162.00
	2001	1994	Aluminum, diamond plate 8.0' side rail, top edge, 1 pair, use w/o bedliner	82203599	0.2	T	184.00
	2001	1994	Bright Aluminum, smooth finish, 4 piece top edge set (front rail top edge, tailgate top edge, pair of side rails) 8.0' bed, use w/o bedliner	82204109	0.5	T	255.00
	2001	1994	Black Aluminum, smooth finish, 4 piece top edge set 8.0' bed (front rail top edge, tailgate top edge, pair of side rails) 8.0' bed, use w/o bedliner	82204114	0.5	T	275.00

*NOTE: Not for use with Over-the-Rail Bedliners.

BED SIDE RAILS

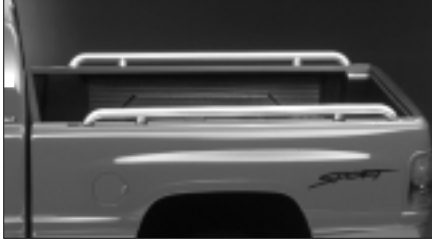

Chrome Bed Rail (shown on Ram Pickup)



Steel Bed Rail (shown on Dakota)



Gasket protection



Additional support legs for stability



Kit and hardware

MOPAR FEATURES	COMPETITORS?*
<ul style="list-style-type: none"> • Large 2.0" tubular diameter brace support for added strength • Gaskets between rail and sheet metal help prevent corrosion • Anodized aluminum resists corrosion, pitting, peeling and is scratch resistant • Chrome is designed to meet 44-hour Copper Accelerated Salt Spray (CASS) test • Should not be used for tie-downs (decoration only) • Mopar Accessories are covered by either the 3-year/36,000-mile New Vehicle Limited Warranty or the 12-month/12,000-mile Mopar Basic Limited Warranty, whichever is more favorable to the customer 	<ul style="list-style-type: none"> • Does it have a smaller tube diameter? • Will it rust? • Are gaskets included to help prevent corrosion? • Is it anodized aluminum? Will it pit or corrode? • Does the chrome finish meet Mopar's standards for durability? • Does it have an E-coat/powder-coat finish, or an enamel finish, which may chip, scratch and rust easily? • Does the warranty compare?

*Check your market for your competitive situation.

INSTALLATION:

- Easily installed
- Some drilling required

BED SIDE RAILS (CONT.)

Vehicle Line	MYO	MYI	Application Remarks	Part Number	Instl Time	Group	Sugg Retail Price
BED SIDE RAILS*							
Dakota Quad Cab	2001	1997	Black steel	82204994	0.5	T	162.00
	2001	1997	Black aluminum	82204992	0.5	T	180.00
	2001	1997	Bright aluminum	82204990	0.5	T	180.00
	2001	1997	Chrome steel	82204986	0.5	T	270.00
Dakota Regular & Club Cab	2001	1997	Black aluminum	82204992	0.5	T	180.00
	2000	1997	Black aluminum	82202778	0.5	T	162.00
	2001	1997	Bright aluminum	82204990	0.5	T	180.00
	2001	1997	Chrome steel	82204986	0.5	T	270.00
	2000	1997	Bright aluminum	82202776	0.5	T	162.00
	2000	1997	Black steel	82202780	0.5	T	154.00
	2000	1997	Chrome steel	82202782	0.5	T	255.00
Ram Pickup w/6.5 Ft. Bed	2001	1994	Black steel	82204994	0.5	T	162.00
	2001	1994	Black aluminum	82204992	0.5	T	180.00
	2001	1994	Bright aluminum	82204990	0.5	T	180.00
	2001	1994	Chrome steel	82204986	0.5	T	270.00
	2000	1994	Black steel	82202780	0.5	T	154.00
	2000	1994	Black aluminum	82202778	0.5	T	162.00
	2000	1994	Bright aluminum	82202776	0.5	T	162.00
	2000	1998	Bright White	82202968	0.5	T	154.00
	2000	1994	Chrome steel	82202782	0.5	T	255.00
	2000	1998	Flame Red	82202966	0.5	T	154.00
Ram Pickup w/8.0 Ft. Bed	2001	1994	Black steel	82202781	0.5	T	175.00
	2001	1994	Black aluminum	82202779	0.5	T	194.00
	2001	1994	Bright aluminum	82202777	0.5	T	194.00
	2001	1994	Chrome steel	82202783	0.5	T	280.00

*NOTE: These products are designed to enhance the appearance of the vehicle. Since their safety characteristics are limited, they are not intended to prevent injury or damage in the event of an accident.

BED WEB NET



Bed Web Net (shown on Ram Pickup)



Bed Web Net (shown on Ram Pickup)

MOPAR FEATURES

- Helps keep cargo in place, and helps prevent lightweight cargo from being thrown out
- Stores easily
- Comes in assorted colors to personalize your Dodge Ram Pickup, made from tough, durable and fade-resistant material
- Mopar Accessories are covered by either the 3-year/36,000-mile New Vehicle Limited Warranty or the 12-month/12,000-mile Mopar Basic Limited Warranty, whichever is more favorable to the customer

COMPETITORS?*

- Are assorted colors available?
- Will material stand up to the elements?
- Does the warranty compare?

*Check your market for your competitive situation.

INSTALLATION:

- Easy installation
- Includes hook attachment

NOTE: Use Mopar Bed Tie-Downs (82202227) to secure net in place (optional).

Vehicle Line	MY0	MY1	Application Remarks	Part Number	Instl Time	Group	Sugg Retail Price
BED WEB NETS*							
Dakota Regular & Club Cab	2001	1997	Black Web Net, for 6.5 ft. bed	82401166	0.3	T	63.00
	2001	1994	Blue Web Net, for 6.5 ft. bed	82202230	0.3	T	63.00
	2001	1994	Red Web Net, for 6.5 ft. bed	82202232	0.3	T	63.00
	2001	1989	Yellow Web Net, for 6.5 ft. bed	82401200	0.3	T	63.00
Ram Pickup w/6.5 Ft. Bed	2001	1994	Red Web Net, for 6.5 ft. bed	82202232	0.3	T	63.00
	2001	1994	Yellow Web Net, for 6.5 ft. bed	82401200	0.3	T	63.00
Ram Pickup w/8.0 Ft. Bed	2001	1994	Blue Web Net, for 8.0 ft. bed	82202231	0.3	T	63.00
	2001	1994	Red Web Net, for 8.0 ft. bed	82202233	0.3	T	63.00
	2001	1994	Yellow Web Net, for 8.0 ft. bed	82401201	0.3	T	63.00
Ram Regular Cab w/6.5' Bed	2001	1994	Black Web Net, for 6.5 ft. bed	82401166	0.3	T	63.00
	2001	1994	Blue Web Net, for 6.5 ft. bed	82202230	0.3	T	63.00
Ram Regular Cab w/8.0' Bed	2001	1994	Black Web Net, for 8.0 ft. bed	82401184	0.3	T	63.00
BED WEB NETS — QUANTITY PURCHASE*							
Dakota (All)	2001	1994	Web Net, color assortment of 12 nets	82202234	0.3		
Ram Pickup (All)	2001	1994	Web Net, color assortment of 12 nets	82202234	0.3		

*Optional: Use bed Tie-Downs on Mopar stake pocket. Tie-Downs to secure net.

BUMPERS



Front Bumper, chrome finish with optional Fog Light brackets (shown on Wrangler)



Rear Bumper, painted finish (shown on Wrangler)

MOPAR FEATURES	COMPETITORS?*
<ul style="list-style-type: none"> • Black or Silver anodized aluminum resists corrosion, pitting, peeling, and is scratch resistant • E-coat primer and powder-coat paint provide a durable finish and match factory colors • Chrome is designed to meet 44-hour CASS (Chrome Accelerated Salt Spray) test, a DaimlerChrysler standard • Bright hexavalent chrome finish • The chrome finish consists of .001-ductile nickel base coating for strength, covered by .0005-semi-bright nickel seal coat and topped with hexavalent chrome plating that provides a bright, rust-resistant product • Mopar uses stainless steel fasteners • 3.0" twin Tubular Bumpers with curved outer ends • Fog Light mounting bracket and front license plate bracket optional • Matches other Mopar tubular accessories • Will not adversely restrict airflow or affect cooling • Designed to meet Federal Motor Vehicle Safety Standards (FMVSS) for occupant protection • Aligns to vehicle frame without drilling • Designed to meet FMVSS lighting requirements • Mandrel tube bending provides a clean appearance without wrinkles in finish • Authentic Jeep® design • Product designed by the creators of the Jeep Wrangler • Mopar Accessories are covered by either the 3-year/36,000-mile New Vehicle Limited Warranty, or the 12-month/12,000-mile Mopar Basic Limited Warranty, whichever is more favorable to the customer 	<ul style="list-style-type: none"> • Is it anodized aluminum? Will it pit or corrode? • Does it have an E-coat/powder-coat finish, or an enamel finish, which may chip, scratch and rust easily? • Does it match factory colors? • Does the chrome finish meet Mopar's standards for finish and durability? • Is it a "duller" cadmium chrome finish? • Are plain steel fasteners used, which may rust? • Is all hardware stainless steel? • Is it a universal fit? • Is it a hang-on design? • Does it restrict airflow and affect cooling? • Has it been designed to meet government occupant protection requirements? • Is drilling required for frame attachment? • Does it restrict the headlight lighting pattern? • Are tubes bent without mandrel, resulting in a flat, unsightly appearance? • Does the warranty compare?

*Check your market for your competitive situation.

INSTALLATION:

- Mounts to existing frame
- All stainless steel hardware included

NOTE: This product is designed solely to enhance the appearance of the vehicle. Since the safety characteristics are limited, it is not intended to prevent injury or damage in the event of an accident.

BUMPERS (CONT.)

Vehicle Line	MYO	MYI	Application Remarks	Part Number	Instl Time	Group	Sugg Retail Price
BUMPER EXTENSIONS*							
Wrangler	2001	1997	Bumper Extensions	82202378	0.3		39.00
BUMPERS, TUBULAR*							
Wrangler	2001	1997	License Plate Bracket for Tubular Front Bumper	82202894	0.2		29.00
	2001	1997	Black steel, rear	82203290	0.4	T	290.00
	2001	1997	Black aluminum, rear	82203294	0.4	T	315.00
	2001	1997	Silver aluminum, rear	82203293	0.4	T	315.00
	2001	1997	Black steel, front	82202173	0.3	T	330.00
	2001	1997	Black Aluminum, front	82202175	0.3	T	340.00
	2001	1997	Silver aluminum, front	82202174	0.3	T	340.00
	2001	1997	Chrome steel, rear	82203295	0.4	T	405.00
	2001	1997	Chrome steel, front	82204269	0.3	T	425.00

*NOTE: These products are designed to enhance the appearance of the vehicle. Since their safety characteristics are limited, they are not intended to prevent injury or damage in the event of an accident.

BUMPERS, REAR STEP (OE STYLE)



Drop-style Step Bumper with Hitch Ball
(shown on Ram Pickup)

MOPAR FEATURES	COMPETITORS?*
<ul style="list-style-type: none"> • Anodized aluminum resists corrosion, pitting, peeling and is scratch resistant • Adhesive gaskets between bed rail protector and vehicle protect bed from damage and rust • Specifically designed to match other Mopar Accessories • Trimmed to match contour of truck bed • Mopar Accessories are covered by either the 3-year/36,000-mile New Vehicle Limited Warranty or the 12-month/12,000-mile Mopar Basic Limited Warranty, whichever is more favorable to the customer 	<ul style="list-style-type: none"> • Is it anodized? Will it pit or corrode? • Are gaskets included? • Do they provide a uniform look when used with other accessories? • Does the warranty compare?

*Check your market for your competitive situation.

INSTALLATION:

- Features rust-resistant self-drilling/sealing screws for easy assembly

Vehicle Line	MYO	MYI	Application Remarks	Part Number	Instl Time	Group	Sugg Retail Price
BUMPERS, REAR STEP (OE STYLE)							
Ram Pickup (All)	2001	1994	License plate housing w/lamps	82401107	0.8	T	14.00
	2001	1995	Argent, w/step pad, 5,000-lb tow rating	82401315	0.8	T	270.00
	2001	1995	Bright, w/step pad, 5,000-lb tow rating	82401316	0.8	T	355.00
BUMPER, DROP STYLE							
Ram Pickup (All)	2000	1994	10 inch drop, 5,000-lb tow rating w/500-lb max tongue load (not for use w/dual-rear wheels or OEM trailer hitch)	82400999	0.8	T	250.00

CARGO AREA LINER



Second- and third-row seat down (shown on Durango)



Hook and loop attachment to seatbacks

MOPAR FEATURES	COMPETITORS?*
<ul style="list-style-type: none"> • Provides protection when carrying messy items • 14-ounce heavy-duty vinyl material • No-drill installation • Custom fit to cover floor and back of seats • Accommodates head restraints without modifications to Cargo Liner; two-piece design accommodates folded second and third seat configurations • Mopar Accessories are covered by either the 3-year/36,000-mile New Vehicle Limited Warranty or the 12-month/12,000-mile Mopar Basic Limited Warranty, whichever is more favorable to the customer 	<ul style="list-style-type: none"> • Is it a lightweight or easily damaged material? • Does it require snaps/drilling? • Does it cover the entire rear cargo surface area? • Does Cargo Liner have to be cut to fit between head restraints? • Does the warranty compare?

*Check your market for your competitive situation.

INSTALLATION:

- Installs and removes easily
- Straps to floor and attaches to seatback with hook and loop fastener

Vehicle Line	MYO	MYI	Application Remarks	Part Number	Instl Time	Group	Sugg Retail Price
CARGO AREA LINER							
Durango	2000	1998	Camel	82203978	D.I.Y.	T	103.00
	2000	1998	Mist Gray	82203979	D.I.Y.	T	103.00
	2001	1998	Black	82203980	D.I.Y.	T	106.00

*Vans with cargo side doors, the Bed Mat must be trimmed.

CARGO AREA MAT



Folding Cargo Mat (shown in Grand Cherokee)



Third-row seat down (shown on Durango)



Second- and third-row seats down (shown on Durango)

MOPAR FEATURES	COMPETITORS?*
<ul style="list-style-type: none"> • Custom fit to interior • Conveniently protects interior • Constructed of high-density polyethylene/rubber blend • No-drill installation • Folding design conveniently covers cargo area as seats are folded down • Folds neatly for storage • Offers protection for the back of bench seats • Unique Mopar product • Patent pending • Heavy construction resists puncture and abrasions from rough and heavy cargo • Skid-resistant surface helps reduce cargo movement • Mopar Accessories are covered by either the 3-year/36,000-mile New Vehicle Limited Warranty, or the 12-month/12,000-mile Mopar Basic Limited Warranty, whichever is more favorable to the customer 	<ul style="list-style-type: none"> • Is it one size fits all? • Does it require snaps/drilling? • Is it a bulky, roll-out design? • Does the warranty compare?

*Check your market for your competitive situation.

INSTALLATION:

Installs and removes easily

Vehicle Line	MYO	MYI	Application Remarks	Part Number	Instl Time	Group	Sugg Retail Price
CARGO AREA MATS							
Cherokee	2001	1997	Black, Mat kit, folding style	82204534	D.I.Y.	T	115.00
Durango	2000	1999	Black, w/2nd seat configuration, 5-passenger	82204799	D.I.Y.	T	112.00
	2000	1999	Black, w/3rd seat configuration, 7/8-passenger	82203795	D.I.Y.	T	112.00
	2001	2001	Black, w/3rd seat configuration, 7/8-passenger	82206408	D.I.Y.	T	112.00
Grand Cherokee	2000	1999	Black, Mat kit, folding style	82204307	D.I.Y.	T	112.00
	2001	1999	Black, Mat kit, folding style	82205985	D.I.Y.	T	115.00

CARGO AREA SECURITY COVER



Cargo Security Cover (shown in Durango)



Without removing headrests



Headrest Attachment



Rear Attachment

MOPAR FEATURES

- Blocks damaging UV rays and hides valuables/clutter from view
- Made of tough, long-lasting original equipment fabric
- High-quality fabrics match vehicle's interior and resist fading
- Custom fit for Durango and Minivan
- Covers rear cargo area behind second-row seat; not retractable
- Mopar Accessories are covered by either the 3-year/36,000-mile New Vehicle Limited Warranty or the 12-month/12,000-mile Mopar Basic Limited Warranty, whichever is more favorable to the customer

COMPETITORS?*

- Does the color match? Will it fade excessively over time?
- Is it a universal item?
- Does the warranty compare?

*Check your market for your competitive situation.

INSTALLATION:

Installs easily

Vehicle Line	MYO	MYI	Application Remarks	Part Number	Instl Time	Group	Sugg Retail Price
CARGO AREA SECURITY COVERS							
Durango	2000	1998	Agate, w/3rd seat	82204126	0.4	T	91.50
	2000	1998	Camel, w/3rd seat	82204124	0.4	T	91.50
	2001	2001	Dark Slate Vinyl, w/3rd seat	82206735	0.4	T	93.00
	2001	2001	Dark Slate Vinyl, w/o 3rd seat	82206732	0.4	T	93.00
	2001	2001	Sandstone, Vinyl, w/3rd Seat	82206737	0.4	T	93.00
	2001	2001	Sandstone, Vinyl, w/o 3rd seat	82206734	0.4	T	93.00
	2000	1998	Agate, w/o 3rd seat	82205146	0.4	T	97.00
	2000	1998	Camel, w/o 3rd seat	82205145	0.4	T	97.00
Minivan (LWB Only)	2001	2001	Navy Blue w/o rear air	82206250*	D.I.Y.	T	130.00
	2001	2001	Sandstone w/o rear air	82206249*	D.I.Y.	T	130.00
	2001	2001	Taupe w/o rear air	82206248*	D.I.Y.	T	130.00
	2001	2001	Navy Blue w/ rear air	82206247*	D.I.Y.	T	150.00
	2001	2001	Sandstone w/ rear air	82206246*	D.I.Y.	T	150.00
	2001	2001	Taupe w/ rear air	82206245*	D.I.Y.	T	150.00
	2000	1996	Camel	82300881	0.2	T	48.00
	2000	1996	Medium Silver Fern	82300880	0.2	T	48.00
	2000	1996	Mist Gray	82300879	0.2	T	48.00
	2000	1996	Taupe	82204970	0.2	T	48.00
Minivan (SWB Only)	2001	2001	Navy Blue	82206253*	D.I.Y.	T	126.00
	2001	2001	Sandstone	82206252*	D.I.Y.	T	126.00
	2001	2001	Taupe	82206251*	D.I.Y.	T	126.00
	2000	1996	Camel	82300865	0.2	T	48.00
	2000	1996	Medium Silver Fern	82300866	0.2	T	48.00
	2000	1996	Mist Gray	82300867	0.2	T	48.00

*Available 1/1/01.

CARGO AREA TRAY, ADJUSTABLE



Molded Cargo Tray (shown in 300M)



Molded Cargo Tray (Stratus)



Adjustable Cargo Tray (shown in Neon)



Adjustable Cargo Organizer
(shown in PT Cruiser)

MOPAR FEATURES	COMPETITORS?*
<ul style="list-style-type: none"> • Molded of thermoplastic rubber for long-lasting wear • Protects and covers full trunk floor • Removes easily for cleaning • Custom molded to protect trunk area • Adjustable Cargo Tray has two easily adjustable dividers, keeping cargo firmly in place • Tray coating and raised area reduce sliding of objects and help protect carpet against spills and stains • Exclusive Mopar logo • Mopar Accessories are covered by either the 3-year/36,000-mile New Vehicle Limited Warranty, or the 12-month/12,000-mile Mopar Basic Limited Warranty, whichever is more favorable to the customer 	<ul style="list-style-type: none"> • Does it cover the entire rear cargo surface area? • Does the tray have a coating or raised area to reduce sliding? • Mopar logo is exclusive to DaimlerChrysler Corporation and Mopar • Does the warranty compare?

*Check your market for your competitive situation.

INSTALLATION:

No tools or special hardware needed

Vehicle Line	MY0	MY1	Application Remarks	Part Number	Instl Time	Group	Sugg Retail Price
CARGO AREA TRAYS — ADJUSTABLE							
Breeze, Cirrus, Stratus	2000	1995	Cargo Area Tray- Adjustable	82300781	D.I.Y.	T	45.00
Minivan (All)	2000	1996	Adjustable Cargo Area Tray	82301044	D.I.Y.	T	34.00
Minivan (LWB Only)	2000	1996	Adjustable Cargo Area Tray	82300811	D.I.Y.	T	48.00
Minivan (SWB Only)	2000	1996	Adjustable Cargo Area Tray	82300810	D.I.Y.	T	45.00
Neon	2001	2000	Black, w/3 separators	82205067	D.I.Y.	T	90.00
PT Cruiser	2001	2001	Black, w/3 separators	82205707	D.I.Y.	T	107.00
Wrangler	2001	1997	Black, molded, use in rear cargo area	82202392	D.I.Y.	T	46.00

CARGO AREA TRAY, CARPET



Molded Carpet Cargo Tray

MOPAR FEATURES

- Custom-molded to fit precisely and protect cargo area and even wheelhouses
- Molded with four raised areas for Cargo Net; use with cargo tie-down loops
- Molded edges and rubber backing keep tray firmly in place
- Color-matched to vehicle interior for a custom look
- Exclusive Jeep® and Mopar Parts embroidered logos
- Stain and moisture resistant surface for easy cleaning, all weather protection and long lasting beauty
- Raised sidewall edges help protect carpet against spills and stains
- Removes easily for cleaning
- Cargo-Loks help prevent items from moving around the cargo tray
- Cargo-Loks are made from high impact rigid thermoplastic with velcro® hooks to grip securely to the surface of the cargo tray
- Mopar Accessories are covered by either the 3-year/36,000-mile New Vehicle Limited Warranty, or the 12-month/12,000-mile Mopar Basic Limited Warranty, whichever is more favorable to the customer

COMPETITORS?*

- Does it cover the entire rear cargo surface area?
- Is it rubber backed?
- Will tray rattle or slide out of position?
- Is it color-matched or a universal black color?
- Jeep and Mopar logos are registered trademarks of Jeep, Mopar and DaimlerChrysler Motors Corporation
- Is it stain and moisture resistant for easy cleaning?
- Does the warranty compare?

*Check your market for your competitive situation.

INSTALLATION:

No tools or special hardware needed

Vehicle Line	MY0	MY1	Application Remarks	Part Number	Instl Time	Group	Sugg Retail Price
CARGO AREA TRAYS — CARPET							
Grand Cherokee	2001	2001	Sandstone	82206880	D.I.Y.	T	105.00
	2001	1999	Agate	82204467	D.I.Y.	T	105.00
	2000	1999	Dark Tan	82204468	D.I.Y.	T	105.00
	2001	1999	Taupe	82204469	D.I.Y.	T	105.00
Minivan (All)	2001	2001	Dark Taupe	82206881	D.I.Y.	T	105.00
	2001	2001	Sandstone	82206882	D.I.Y.	T	105.00
	2001	2001	Navy Blue	82206883	D.I.Y.	T	105.00

CARGO AREA TRAY, MOLDED



Molded Cargo Tray
(shown in Grand Cherokee)



Molded Cargo Tray (shown in Cherokee)



Molded Cargo Tray (shown in Voyager)



Molded Cargo Tray (shown in Durango)



Molded Cargo Tray (shown in PT Cruiser)

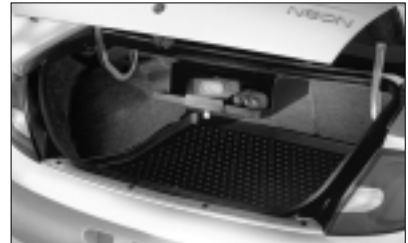

Molded Cargo Tray (shown in Neon)



Cargo Organizer Tray (shown in Durango)

MOPAR FEATURES

- Custom-fit Vy-ram flexible, non-skid rubber tray with 2" walls to protect cargo area
- Protects cargo area carpet from grease, dirt, grime and spills
- Easily installed and removed
- No attachments required; allows easy access to cargo tie-downs
- Exclusive Jeep®, Dodge or Mopar logo
- Mopar Accessories are covered by either the 3-year/36,000-mile New Vehicle Limited Warranty, or the 12-month/12,000-mile Mopar Basic Limited Warranty, whichever is more favorable to the customer

COMPETITORS?*

- Is it a universal or multifit tray with no walls to protect against spills?
- Jeep and Mopar logos are exclusive to DaimlerChrysler Corporation, Jeep, Dodge and Mopar
- Does the warranty compare?

*Check your market for your competitive situation.

INSTALLATION:

- Installs in minutes
- No tools required

CARGO AREA TRAY, MOLDED (CONT.)

Vehicle Line	MY0	MY1	Application Remarks	Part Number	Instl Time	Group	Sugg Retail Price
CARGO AREA TRAYS — MOLDED							
300M	2001	1998	Black	82203624	D.I.Y.	T	62.00
Avenger, Sebring Coupe	2000	1995	Black	82301009	D.I.Y.	T	52.00
Breeze, Cirrus, Stratus	2000	1995	Black	82300780	D.I.Y.	T	52.00
Cherokee	2001	1984	Agate	82206581	D.I.Y.	T	79.00
	2001	1999	Camel	82206582	D.I.Y.	T	79.00
Concorde, LHS	2001	1998	Black	82203622	D.I.Y.	T	55.00
Dakota Quad Cab	2000	2000	Mist Gray, rear seat floor area	82205246	D.I.Y.	T	100.00
	2001	2000	Agate, rear seat floor area	82205245	D.I.Y.	T	103.00
	2001	2001	Dark Taupe	82207135	D.I.Y.	T	103.00
Durango	2000	1998	Agate w/3rd seat	82203983	D.I.Y.	T	60.00
	2000	1998	Camel w/3rd seat	82203981	D.I.Y.	T	60.00
	2001	2001	Sandstone w/3rd seat	82205456	D.I.Y.	T	60.00
	2001	2001	Taupe w/3rd seat	82205457	D.I.Y.	T	60.00
	2001	2001	Dark Slate Gray w/3rd seat	82205455	D.I.Y.	T	60.00
	2000	1998	Mist Gray w/3rd seat	82203982	D.I.Y.	T	60.00
	2000	1999	Agate w/o 3rd seat	82204806	D.I.Y.	T	79.00
	2000	1999	Camel w/o 3rd seat	82204805	D.I.Y.	T	79.00
	2001	2001	Sandstone w/o 3rd seat	82206523	D.I.Y.	T	79.00
	2001	2001	Taupe w/o 3rd seat	82206526	D.I.Y.	T	79.00
	2001	2001	Dark Slate w/o 3rd seat	82206527	D.I.Y.	T	79.00
	2000	1999	Mist Gray w/o 3rd Seat	82204807	D.I.Y.	T	79.00
Grand Cherokee	2000	1999	Camel	82204440	D.I.Y.	T	79.00
	2001	1999	Agate	82204439	D.I.Y.	T	82.00
	2001	1999	Taupe	82204311	D.I.Y.	T	82.00
	2001	2001	Sandstone	82206410	D.I.Y.	T	82.00
Intrepid	2001	1998	Black	82203623	D.I.Y.	T	55.00
Minivan (All)	2001	2001	Navy Blue, LWB, w/o rear A/C	82206913	D.I.Y.	T	46.00
	2001	2001	Sandstone, LWB, w/o rear A/C	82206914	D.I.Y.	T	46.00
	2001	2001	Taupe, LWB, w/o rear A/C	82206912	D.I.Y.	T	46.00
	2001	2001	Navy Blue, LWB, w/rear A/C	82205911	D.I.Y.	T	46.00
	2001	2001	Sandstone, LWB, w/rear A/C	82205912	D.I.Y.	T	46.00
	2001	2001	Taupe, LWB, w/rear A/C	82205910	D.I.Y.	T	46.00
	2001	2001	Dark Taupe, SWB	82205907	D.I.Y.	T	46.00
	2001	2001	Sandstone, SWB	82205909	D.I.Y.	T	46.00
2001	2001	Navy Blue, SWB	82205908	D.I.Y.	T	46.00	

CARGO AREA TRAY, MOLDED (CONT.)

Vehicle Line	MYO	MYI		Application Remarks	Part Number	Instl Time	Group	Sugg Retail Price
CARGO AREA TRAYS — MOLDED (CONT.)								
Minivan (LWB Only)	2000	1996	1200	Black	82300809	D.I.Y.	T	56.00
	2000	1996	3125	Camel	82202352	D.I.Y.	T	60.00
	2000	1996	2200	Medium Silver Fern	82202356	D.I.Y.	T	60.00
	2000	1996	3125	Mist Gray	82202354	D.I.Y.	T	60.00
	2000	1996	3125	Taupe	82204889	D.I.Y.	T	60.00
	2000	1996	3500	Camel, vinyl	82203286	D.I.Y.	T	100.00
	2000	1996	3500	Mist Gray, vinyl	82203287	D.I.Y.	T	100.00
	2000	1996	3500	Silver Fern, vinyl	82203285	D.I.Y.	T	100.00
Minivan (SWB Only)	2000	1996	1300	Black	82300808	D.I.Y.	T	52.00
	2000	1996	1400	Camel	82202351	D.I.Y.	T	60.00
	2000	1996	2200	Medium Silver Fern	82202355	D.I.Y.	T	60.00
	2000	1996	2200	Mist Gray	82202353	D.I.Y.	T	60.00
Neon	2001	2000		Black	82204787	D.I.Y.	T	55.00
PT Cruiser	2001	2001	4800	Dark Taupe w/logo	82205459	D.I.Y.	T	67.00
Sebring Convertible	2000	1996		Black	82202056	D.I.Y.	T	52.00
	2001	2001		Flexible	82205965	D.I.Y.	T	79.00
Sebring Coupe, Stratus Coupe	2001	2001		Black, in trunk	82206026	D.I.Y.	T	79.00
Sebring Sedan, Stratus Sedan	2001	2001		Molded	82205964	D.I.Y.	T	79.00

CARGO BARRIER



MOPAR FEATURES

- Custom fit cargo barrier is constructed from steel
- Keeps cargo secure in the cargo area and prevents it from entering the passenger compartment
- Grid construction modular design allows for a custom fit barrier
- Upper section to be used with rear seat in up position. Lower section to be used when rear seat is down in conjunction with upper section
- Mopar Accessories are covered by either the 3-year/36,000-mile New Vehicle Limited Warranty, or the 12-month/12,000-mile Mopar Basic Limited Warranty, whichever is more favorable to the customer

COMPETITORS?*

- Is it constructed from steel?
- Does it keep cargo secure and prevent it from entering the passenger compartment?
- Does it have a custom fit grid construction modular design?
- Does the warranty compare?

*Check your market for your competitive situation.

INSTALLATION:

Vehicle Line	MY0	MY1	Application Remarks	Part Number	Instl Time	Group	Sugg Retail Price
CARGO BARRIER							
Grand Cherokee	2001	2001	Upper	82206328	1.5		173.00
	2001	2001	Lower	82205441	D.I.Y.		86.00

CARGO NET



Envelope Cargo Net (shown in Grand Cherokee)



Vertical Barrier Net (shown in Grand Cherokee)



Envelope Cargo Net (shown in Neon)



Vertical Cargo Net (shown in Durango)



"T" hooks

MOPAR FEATURES

- Custom designed to fit cargo area
- Helps hold cargo in place
- Easily removable
- Unique hooks allow for strong retention and easy net removal
- Netting mounts at tailgate (Envelope)
- Netting mounts to existing vehicle tie-downs and installed mounting anchors in roof (Vertical Barrier)
- Made of black elastic netting
- Meets OE testing standards for flammability and durability
- Mopar Accessories are covered by either the 3-year/36,000-mile New Vehicle Limited Warranty, or the 12-month/12,000-mile Mopar Basic Limited Warranty, whichever is more favorable to the customer

COMPETITORS?*

- Is it a universal fit?
- Do hooks remove easily?
- Does net meet OE testing standards?
- Does the warranty compare?

*Check your market for your competitive situation.

INSTALLATION:

- Easily installed
- Includes black nylon net, four hooks and draw straps; use with cargo tie-down loops on vehicle (Envelope)
- Can be used with or without a Cargo Tray (Envelope)
- Hand tools required

CARGO NET (CONT.)

Vehicle Line	MYO	MYI	Application Remarks	Part Number	Instl Time	Group	Sugg Retail Price
CARGO NETS							
Avenger, Sebring Coupe	2000	1995	Envelope Net, w/hardware, provides a pocket to hold cargo in trunk	82300755	0.3	T	26.00
Breeze, Cirrus, Stratus	2000	1995	Vertical Net, w/hardware, same as OE	04698120	0.2	T	29.25
	2000	1995	Envelope Net, w/hardware, provides a pocket to hold cargo in trunk	82300901	0.2	T	26.00
Cherokee	2001	1984	Vertical Barrier Net, attaches to floor and ceiling	82204057	0.3	T	43.00
Durango	2001	1998	Vertical Barrier Net, attaches to floor and ceiling	82204518	0.3	T	43.00
Grand Cherokee	2001	1999	Envelope Net, w/hardware	82204619	0.2	T	23.00
	2001	1999	Vertical Barrier Net, attaches to floor and walls	82204310	0.3	T	43.00
Minivan (All)	2000	1996	Underseat Cargo Net	82300813	0.2	T	21.00
	2001	1996	Envelope Net, w/hardware, some drilling required	82300812	0.4	T	38.00
Neon	2001	2000	Envelope Net, w/hardware, provides a pocket to hold cargo in trunk	82204838	0.2	T	27.00
Ram Pickup - Regular Cab (All)	2000	1994	Net, large size, for storage tray	82401180	D.I.Y.	T	24.00
Sebring Convertible	2000	1996	Envelope Net, w/hardware, provides a pocket to hold cargo in trunk	82202045	0.2	T	27.00
Sebring Sedan & Conv., Stratus Sedan, Concorde, Intrepid, LHS, 300M	2001	1998	Envelope Net, w/hardware	04787493AA	0.2	T	54.00
Wrangler	2001	1997	Rear Cargo Net, attaches to floor using existing "D" rings	55217379	0.2	T	33.00

CARGO ORGANIZER™ MINIVAN



Molded Carpet Cargo Tray
(shown in Minivan)

MOPAR FEATURES	COMPETITORS?*
<ul style="list-style-type: none"> • Mounted higher, creates an additional shelf for more storage • When folded flat, it can be used as a security cover to hide items stored below. • Mopar Accessories are covered by either the 3-year/36,000-mile New Vehicle Limited Warranty, or the 12-month/12,000-mile Mopar Basic Limited Warranty, whichever is more favorable to the customer 	<ul style="list-style-type: none"> • Does it mount higher to create more storage space? • Can it be used as a security cover? • Does the warranty compare?

*Check your market for your competitive situation.

INSTALLATION:

- Easily installed

Vehicle Line	MYO	MYI	Application Remarks	Part Number	Instl Time	Group	Sugg Retail Price
CARGO AREA TRAYS, CARGO ORGANIZER™							
Minivan (LWB)	2001	2001	Navy Blue, OE-style	82206265*†	0.7		TBD
	2001	2001	Sandstone, OE-style	82206264*†	0.7		TBD
	2001	2001	Taupe, OE-style	82206263*†	0.7		TBD

*Available 1/1/01.

† Only available for long wheelbase vehicles with rear A/C.

CELLULAR PHONE HOLDER



Dakota



Jeep



Sebring

MOPAR FEATURES

- The arms of this electronic instrument panel-mounted phone holder grasp your phone gently and secure it firmly in an easy to reach position
- Adjustable rubber feet offer added phone support while the one-touch-release feature allows for quick phone removal
- The holder includes a branched cord that plugs into your vehicle's power outlet, allowing simultaneous connection to other accessories
- Installs in minutes without drilling using radio mounting screws and accommodates any cellular phone, PCS phone or accessory
- Engineered to not interfere with SRS (air bag) deployment
- Mopar Accessories are covered by either the 3-year/36,000-mile New Vehicle Limited Warranty, or the 12-month/12,000-mile Mopar Basic Limited Warranty, whichever is more favorable to the customer

COMPETITORS?*

- Will it obstruct SRS or other safety systems?
- Does the warranty compare?

*Check your market for your competitive situation.

INSTALLATION:

Installs to the vehicle instrument panel, uses radio mounting screws, requires no drilling for installation.

CELLULAR PHONE HOLDER (CONT.)

Vehicle Line	MYO	MYI	Application Remarks	Part Number	Instl Time	Group	Sugg Retail Price
CELLULAR PHONE HOLDER, ELECTRONIC							
Breeze, Cirrus, Stratus, Sebring Convertible	2000	1995	Cellular Phone Holder, Electronic One (1) kit, black w/Mopar logo	82205273	0.2		50.00
Sebring Sedan & Conv., Stratus Sedan	2001	2001	Cellular Phone Holder, Electronic One (1) kit, black w/Mopar logo	82206018	0.2		50.00
Cherokee	2001	1999	Cellular Phone Holder, Electronic One (1) kit, black w/Jeep logo	82205274	0.2		50.00
Concorde, Intrepid, LHS, 300M	2001	1998	Cellular Phone Holder, Electronic (25) kit units,	82205709	0.2		
	2001	1998	Cellular Phone Holder, Electronic One (1) kit, black w/Mopar logo	82205270	0.2		50.00
Dakota, Durango	2000	1997	Cellular Phone Holder, Electronic (25) kit units, black w/Dodge logo	82205477	0.3		
	2000	1997	Cellular Phone Holder, Electronic One (1) kit, black w/Dodge logo	82205268	0.3		50.00
	2001	2001	Cellular Phone Holder, Electronic One (1) kit, black w/Dodge logo	82206685	0.3		50.00
Grand Cherokee	2001	1999	Cellular Phone Holder, Electronic (25) kit units, black w/Jeep logo	82205443	0.2		
	2001	1999	Cellular Phone Holder, Electronic One (1) kit, black w/Jeep logo	82204332	0.2		50.00
Neon	2001	2000	Cellular Phone Holder, Electronic One (1) kit, black w/Mopar logo	82205276	0.2		50.00
PT Cruiser	2001	2001	Cellular Phone Holder, Electronic One (1) kit, black w/Mopar logo	82205729	0.2		50.00
Ram Pickup (All)	2001	1998	Cellular Phone Holder, Electronic (25) kit units, black w/Dodge logo	82205478*	0.3		
	2001	1998	Cellular Phone Holder, Electronic One (1) kit, black w/Dodge logo	82205269	0.3		50.00

*Fits bucket seats only.

CONSOLES, CENTER



Premium Console (shown in Wrangler)



Minivan Console

MOPAR FEATURES	COMPETITORS?*
<ul style="list-style-type: none"> • Color/material match interior • Same as OE • Includes two cup holders • Includes key lock • Lid opens easily for quick access to contents • Lockable storage for cassettes, glasses and other valuables • High enough to rest arm comfortably • Provision for air bag switch • Mopar Accessories are covered by either the 3-year/36,000-mile New Vehicle Limited Warranty, or the 12-month/12,000-mile Mopar Basic Limited Warranty, whichever is more favorable to the customer 	<ul style="list-style-type: none"> • Is it a universal color or a true match? • Is it a universal fit? • Is it lockable? • Is it too low to be comfortable? • Does the warranty compare?

*Check your market for your competitive situation.

INSTALLATION:

- Mounts to floor
- Comes complete with installation hardware and instructions

Vehicle Line	MY0	MY1	Application Remarks	Part Number	Instl Time	Group	Sugg Retail Price
CONSOLES, CENTER							
Wrangler	2000	1999	Console, Agate, same as OE, lockable	82204774*	0.5	T	118.00
	2000	1999	Console, Camel, same as OE, lockable	82204775*	0.5	T	118.00
	2001	2001	Console, Agate, w/lock, w/o speaker	82206342	0.5	T	140.00
	2001	2001	Console, Camel, w/lock, w/o speaker	82206341	0.5	T	140.00

*Dealer will need to add Lock Tumbler to match ignition.

CONSOLES, MINIVAN

Vehicle Line	MYO	MYI	Application Remarks	Part Number	Instl Time	Group	Sugg Retail Price
CONSOLES, CENTER — MINIVAN							
Caravan (All), Grand Caravan (All), Voyager (All), Grand Voyager (All), Town & Country LXi FWD	2000	1996	Camel	82203260	0.7	T	180.00
	2000	1996	Mist Gray	82203259	0.7	T	180.00
	2000	1996	Silver Fern	82203261	0.7	T	180.00
Minivan (All)	2001	2001	Navy Blue, center console mounting kit	82206260	0.6	T	125.00
	2001	2001	Navy Blue, OE-style	82206257*	D.I.Y.	T	125.00
	2001	2001	Sandstone, center console mounting kit	82206261	0.6	T	125.00
	2001	2001	Sandstone, OE-style	82206258*	D.I.Y.	T	125.00
	2001	2001	Taupe, center console mounting kit	82206262	0.6	T	125.00
	2001	2001	Taupe, OE-style	82206259*	D.I.Y.	T	125.00
	2001	2001	Wiring kit for console power outlet and light	82206972	TBD		TBD
CONSOLES, FRONT — MINIVAN							
Minivan (All)	2000	1996	Camel, w/closed storage, OE-style	82300815	0.3	T	53.00
	2000	1996	Medium Silver Fern, w/closed storage, OE-style	82300816	0.3	T	53.00
	2000	1996	Mist Gray, w/closed storage, OE-style	82300817	0.3	T	53.00
CONSOLES, PASSENGER SEAT MOUNT — MINIVAN							
Minivan (All)	2000	1999	Camel, w/lockable door	82205062	0.6	T	113.00
	2000	1999	Mist Gray, w/lockable door	82205061	0.6	T	113.00
	2000	1999	Silver Fern, w/lockable door	82205064	0.6	T	113.00

*Can only be installed in front position for short wheelbase vehicles. Available for both front and rear positions in long wheelbase vehicles.

COOLER INSERT



Removable Console



Cooler Insert

MOPAR FEATURES

- Custom made to fit center-floor console
- Has a handle for easy portability
- Available with Dodge or Chrysler logos
- Mopar Accessories are covered by either the 3-year/36,000-mile New Vehicle Limited Warranty, or the 12-month/12,000-mile Mopar Basic Limited Warranty, whichever is more favorable to the customer

COMPETITORS?*

- Is it custom fit for the console?
- Is it portable?
- Logos are exclusive to DaimlerChrysler, Dodge, Chrysler and Mopar
- Does the warranty compare?

*Check your market for your competitive situation.

Vehicle Line	MYO	MYI	Application Remarks	Part Number	Instl Time	Group	Sugg Retail Price
COOLER INSERTS							
Minivan (All)	2001	2001	Cooler Insert, w/Chrysler Logo	82206510	D.I.Y.		34.00
	2001	2001	Cooler Insert, w/Dodge Logo	82206708	D.I.Y.		34.00

COVERS, COCKPIT & LUGGAGE



Cockpit Cover (shown on Viper)



Luggage Carrier (shown on Viper)

MOPAR FEATURES

- Helps protect vehicle interior
- Constructed of lightweight, breathable Ultralon material that is heat repellent which helps keep the interior cool
- Easy to install and east to store once removed
- Features the Viper RT/10 logo
- Mopar Accessories are covered by either the 3-year/36,000-mile New Vehicle Limited Warranty, or the 12-month/12,000-mile Mopar Basic Limited Warranty, whichever is more favorable to the customer

COMPETITORS?*

- Is it constructed of lightweight material?
- Is it heat repellent to keep the interior cool?
- Is it easy to install and easy to store after removal?
- Viper logo is a registered trademark of Dodge and DaimlerChrysler Corporation
- Does the warranty compare?

*Check your market for your competitive situation.

Vehicle Line	MYO	MYI	Application Remarks	Part Number	Instl Time	Group	Sugg Retail Price
COVERS, COCKPIT							
Viper RT/10	2001	1993	Gray, Ultralon material w/embroidered Red Viper Logo, covers passenger compartment only when top is removed	82202276	0.3	T	96.00
COVERS, LUGGAGE CARRIER							
Viper RT/10	2001	1992	Use w/Viper Deck Lid Mounted Luggage Carrier	82204450	0.5	T	190.00

COVERS, FRONT-END



Prowler



Wrangler



Grand Cherokee Laredo



Town & Country



PT Cruiser



300M



Intrepid



Cold-Weather Cover
(shown on Ram Pickup)



Front-End Cover
(shown on Ram Pickup)



Hood attachment with
elastic hood fasteners
(some applications)



Fender snaps for Front-End
Cover (some applications)



Plastic strip for wheel well
attachment



Fender J-hook attachment
(some applications)



Underhood adjuster strap
with J-hook

INSTALLATION:

- Various fastener styles provide tighter fit and facilitate installation and removal
- Adjustable J-hooks for hood; padded plastic strips and J-clips for fascia/fenders and bumpers. Snaps are used for some fender applications
- Hand tools required for initial installation of snaps



J-hook on elastic strap



Underhood adjuster strap



Screen net over grille

MOPAR FEATURES

- Durable and breathable black vinyl fabric
- Nylon screen protects grille and fascia openings
- Designed to fit tight and match front-end contours
- Custom fasteners facilitate installation and removal
- Unique two-piece design allows the hood to open without removing the cover
- Embroidered silver vehicle logo
- Custom "turned-under and sewn" edges for finished, stylish appearance
- 22-ounce foss backing on specific models helps protect paint surface
- DaimlerChrysler-tested to ensure limited degradation of cooling system performance
- Mopar Accessories are covered by either the 3-year/36,000-mile New Vehicle Limited Warranty, or the 12-month/12,000-mile Mopar Basic Limited Warranty, whichever is more favorable to the customer

COMPETITORS?*

- Is it cloth or vinyl?
- Does it have a screen to protect openings?
- Is the netting fiberglass, which may scratch paint?
- Is it a custom fit?
- Does it have fewer attachment points, causing a poorer fit?
- Do you have to remove the cover to open the hood?
- Logos are exclusive to DaimlerChrysler Corporation and Mopar
- Are the edges turned under?
- Does it have an unfinished appearance?
- Does it have backing?
- Has it been tested to ensure it does not degrade cooling system performance?
- Does the warranty compare?

*Check your market for your competitive situation.

COVERS, FRONT-END (CONT.)

Vehicle Line	MY0	MY1	Application Remarks	Part Number	Instl Time	Group	Sugg Retail Price
COVERS, FRONT END							
300M	2001	1998	Black, w/300M logo, w/license plate opening	82203629*	0.3	T	126.00
	2001	1998	Black, w/300M logo, w/o license plate opening	82203630*	0.3	T	126.00
Avenger	2000	1997	Black, w/Avenger logo, w/ or w/o license plate opening	82203266*	0.3	T	101.00
Breeze	2000	1996	Black, w/silver Breeze logo, w/front license plate opening	82202082*	0.3	T	101.00
	2000	1996	Black, w/silver Breeze logo, w/o front license plate opening	82202081*	0.3	T	101.00
Caravan, Grand Caravan - All ex. SE & Sport	2000	1999	Black, w/Ram's Head logo, w/license plate opening, ES, LE, Sport	82204959	0.3	T	101.00
	2000	1999	Black, w/Ram's Head logo, w/o license plate opening ES, LE, Sport	82204960	0.3	T	101.00
Caravan, Grand Caravan - SE & Sport Only	2000	1999	Black, w/Ram's Head logo, w/license plate opening, Base, SE	82300851	0.3	T	101.00
	2000	1999	Black, w/Ram's Head logo, w/o license plate opening, Base, SE	82300852	0.3	T	101.00
Cherokee	2001	1997	Black, w/Jeep logo, w/o front license plate opening	82203169	0.3	T	110.00
Cirrus LXi	2000	1995	Black, w/silver Cirrus logo, w/front license plate opening	82300784*	0.3	T	101.00
	2000	1995	Black, w/silver Cirrus logo, w/o front license plate opening	82300792*	0.3	T	101.00
Concorde, LHS	2001	1998	Black, w/Concorde logo, w/license plate opening	82203628*	0.3	T	126.00
	2001	1998	Black, w/Concorde logo, w/o license plate opening	82203627*	0.3	T	126.00
Dakota (All)	2001	1997	Black, w/Ram's Head logo, w/ or w/o fog light openings, w/license plate opening	82202955	0.3	T	143.00
Durango	2001	1998	Black, w/Ram's Head logo, w/ or w/o fog light openings, w/license plate opening	82202955	0.3	T	143.00
Grand Caravan ES (FWD & AWD)	2001	2001	Black, w/ Ram's Head Logo	82206380	0.3	T	126.00
	2001	2001	Black, w/ Ram's Head logo, w/o license plate opening	82206381	0.3	T	126.00
Grand Cherokee	2001	1999	Black, w/Jeep logo, w/license plate opening, Laredo	82205244	0.3	T	139.00
	2001	1999	Black, w/Jeep logo, w/o license plate opening, Laredo	82205243	0.3	T	139.00
	2001	1999	Black, w/Jeep logo, w/o license plate opening, Limited	82204528	0.3	T	139.00
	2001	1999	Black, w/Jeep logo, w/o license plate opening, Limited	82204663	0.3	T	139.00

*Not recommended for use with Ground Effects Package.

COVERS, FRONT-END (CONT.)

Vehicle Line	MY0	MY1	Application Remarks	Part Number	Instl Time	Group	Sugg Retail Price
COVERS, FRONT END (CONT.)							
Intrepid	2001	1998	Black, w/Intrepid logo, w/fog light openings, w/license plate opening	82203625*	0.3	T	126.00
	2001	1998	Black, w/Intrepid logo, w/fog light openings, w/o license plate opening	82203626*	0.3	T	126.00
Intrepid SE	2001	1998	Black, w/Intrepid logo, w/license plate opening	82204010*	0.3	T	126.00
	2001	1998	Black, w/Intrepid logo, w/o license plate opening	82204014*	0.3	T	126.00
LHS	2001	1998	Black, w/LHS logo, w/license plate opening	82203632*	0.3	T	126.00
	2001	1998	Black, w/LHS logo, w/o license plate opening	82203631*	0.3	T	126.00
Neon	2001	2000	Black, w/silver Neon logo, w/front license plate opening	82204535*	0.3	T	105.00
	2001	2000	Black, w/silver Neon logo, w/o front license plate opening	82204536	0.3	T	105.00
Prowler	2001	1998	Black, for trailer	82203789*	0.3	T	155.00
	2001	1998	Black, w/embroidered Plymouth logo	82203786*	0.3	T	200.00
PT Cruiser	2001	2001	Black, w/PT Cruiser logo, w/license plate opening	82205447	0.3	T	143.00
	2001	2001	Black, w/PT Cruiser logo, w/o license plate opening	82205448	0.3	T	143.00
Ram Pickup (All)	2001	1999	Black, Ram Sport, full cover, includes hood, fender and bumper covering, w/Bug Screen, w/o license plate opening	82204422	0.3	T	162.00
	2001	1999	Black, w/Ram's head logo, w/ license plate opening	82205820	0.3	T	162.00
	2001	1994	Black, full cover, includes hood, fender and bumper covering, w/Bug Screen	82401071 [†]	0.3	T	186.00
Sebring Convertible	2000	1996	Black, w/silver Sebring logo, w/front license plate opening	82202047*	0.3	T	101.00
	2000	1996	Black, w/silver Sebring logo, w/o front license plate opening	82202046*	0.3	T	101.00
	2001	2001	Black, w/ Chrysler logo, w/license plate opening	82206389*	0.3	T	122.00
	2001	2001	Black, w/Chrysler logo, w/o license plate opening,	82206390*	0.3	T	122.00
Sebring Coupe	2000	1997	Black, w/Sebring logo, w/license plate opening	82203265*	0.3	T	101.00
	2000	1997	Black, w/Sebring logo, w/o license plate opening	82203264*	0.3	T	101.00
	2001	2001	Black, w/o license plate opening, w/Sebring logo	82206352*	0.3	T	138.00
	2001	2001	Front End Cover, Black w/license plate opening, w/Sebring logo	82206351*	0.3	T	138.00
Sebring Sedan	2001	2001	Black, w/Chrysler logo, w/ license plate opening	82206035*	0.3	T	122.00
	2001	2001	Black, w/Chrysler logo, w/o license plate opening	82206036*	0.3	T	122.00
Stratus	2000	1995	Black, w/silver Stratus logo, w/front license plate opening	82300905*	0.3	T	101.00
	2000	1995	Black, w/silver Stratus logo, w/o front license plate opening	82300906*	0.3	T	101.00
Stratus Coupe	2001	2001	Black, w/o license plate opening, w/ Stratus logo	82206350	0.3	T	138.00
	2001	2001	Black, w/license plate opening, w/ Stratus logo	82206349	0.3	T	138.00
Stratus Sedan	2001	2001	Black, w/Stratus logo, w/ license plate opening	82206033	0.3	T	122.00
	2001	2001	Black, w/Stratus logo, w/o license plate opening	82206034	0.3	T	122.00
Town & Country (All)	2000	1998	Black, w/Chrysler logo, w/license plate opening	82204055	0.3	T	101.00
	2000	1998	Black, w/Chrysler logo, w/o license plate opening	82204015	0.3	T	101.00

*Not recommended for use with Ground Effects Package.

[†]Excludes 2000/1999 Ram Pickup.

COVERS, FRONT-END (CONT.)

Vehicle Line	MYO	MYI	Application Remarks	Part Number	Instl Time	Group	Sugg Retail Price
COVERS, FRONT END (CONT.)							
Town & Country AWD	2001	2001	Black w/ Chrysler Logo	82206384	0.3	T	126.00
	2001	2001	Black w/Chrysler logo	82206385	0.3	T	126.00
Viper Coupe	2001	1997	Black, w/embroidered Blue Viper logo	82202819	0.3	T	148.00
Viper RT/10	2001	1998	Front End Cover - w/Silver Viper Logo	82204631	0.3	T	148.00
Voyager (FWD)	2001	2001	Black, w/Chrysler logo	82206382	0.3	T	126.00
	2001	2001	Black, w/Chrysler logo	82206383	0.3	T	126.00
Voyager, Grand Voyager (All FWD)	2000	1996	Black, w/Voyager logo, w/license plate opening	82300607*	0.3	T	97.00
	2000	1996	Black, w/Voyager logo, w/o license plate opening	82300608*	0.3	T	97.00
Wrangler - Sport & SE	2001	1997	Black, w/Jeep logo, w/black flares, SE and Sport	82204176	0.3	T T	110.00
Wrangler Sahara	2001	1997	Black, w/Jeep logo, w/painted flares, Sahara	82204177 [†]	0.3	T	110.00
COVERS, FRONT END — COLD WEATHER							
Ram Pickup - Regular Cab (All)	2001	1994	Black, w/zipper opening, diesel only	82401075	0.3	T	96.00

*Not recommended for use with Ground Effects Package.

[†]Fits vehicles built after 1/1/97.

[†]Fits Wranglers with rubber fender flares that are flush with top front fender.

COVERS, HOOD



Hood Cover (shown on Ram Pickup)



Durango/Dakota



Town & Country



Concorde



T-style Hood Cover (shown on Wrangler)



Caravan



Intrepid



Sebring Sedan

MOPAR FEATURES

- Custom “turned-under” edges for improved, finished appearance
- Embroidered logo
- Black vinyl cover with 22-ounce foss backing
- Mopar Accessories are covered by either the 3-year/36,000-mile New Vehicle Limited Warranty, or the 12-month/12,000-mile Mopar Basic Limited Warranty, whichever is more favorable to the customer

COMPETITORS?*

- Are the edges turned under? Does it have an unfinished appearance?
- Logos are exclusive to DaimlerChrysler Corporation and Mopar
- Does it have backing?
- Does the warranty compare?

*Check your market for your competitive situation.

INSTALLATION:

- No tools required
- Uses existing holes in hood for attachment
- Same design attachments as the Front-End Cover

COVERS, HOOD (CONT.)

Vehicle Line	MYO	MYI	Application Remarks	Part Number	Instl Time	Group	Sugg Retail Price
COVERS, HOOD							
300M	2001	1998	Black, w/300M logo	82204504	D.I.Y.	T	49.00
Avenger, Sebring Coupe	2000	1995	Black	82300756	D.I.Y.	T	47.00
Breeze, Cirrus, Stratus	2000	1995	Black	82300783	D.I.Y.	T	47.00
Caravan, Grand Caravan (FWD & AWD)	2000	1996	Black, w/Ram's Head logo	82202048	D.I.Y.	T	47.00
Grand Caravan	2001	2001	Black	82206387	0.3	T	49.00
Concorde, LHS	2001	1998	Black, w/Concorde logo	82204317	D.I.Y.	T	49.00
Dakota (All)	2001	1997	Black, w/Ram's Head logo, w/Bug Screen	82202721	0.2	T	49.00
Durango	2001	1998	Black, w/Ram's Head logo, w/Bug Screen	82202721	0.2	T	49.00
Grand Cherokee	2001	1999	Black, w/embroidered Jeep logo	82204313	0.2	T	49.00
Intrepid	2001	1998	Black, w/Intrepid logo	82204316	D.I.Y.	T	49.00
LHS	2001	1998	Black, w/LHS logo	82204505	D.I.Y.	T	49.00
Minivan (All)	2000	1996	Black	82300853	D.I.Y.	T	47.00
Neon	2001	2000	Black, w/Neon logo	82204537	0.2	T	49.00
PT Cruiser	2001	2001	Black, w/PT Cruiser logo	82205449	0.3	T	50.00
Ram Pickup (All)	2001	1999	Black, hood only, w/Bug Screen	82401074	0.3	T	75.00
	2001	1999	Black, Ram Sport, hood and fenders, w/Bug Screen	82204424	0.3	T	103.00
	2001	1999	Black, hood and fenders, w/Bug Screen	82401072	0.3	T	123.00
Sebring (Sedan & Conv)	2001	2001	Black, w/Chrysler logo	82206391	0.3	T	49.00
Sebring Convertible	2000	1996	Black, w/embroidered silver Sebring logo	82202054	D.I.Y.	T	47.00
Sebring Coupe	2001	2001	Black, w/Sebring logo	82206535	0.3	T	49.00
Stratus Coupe	2001	2001	Black, w/Stratus logo	82206353	0.3	T	49.00
Stratus Sedan	2001	2001	Black, with logo, for all 4-door cars	82206037	0.3	T	49.00
Town & Country AWD	2001	2001	Black, w/Chrysler logo	82206529	0.3	T	49.00
Wrangler	2001	1997	Black, T-style, w/large Jeep logo	82204175* [†]	0.2	T	49.00
	2001	1997	Black, w/Jeep logo	82204174* [†]	0.2	T	49.00

*Fits vehicles built after 1/1/97.

[†]Fits Wranglers with rubber fender flares that are flush with top front fender.

COVERS, SPARE TIRE, DELUXE ANTITHEFT



Deluxe Tire Cover with White logo (shown on Wrangler)



Zippered closure



Molded plastic mounting

MOPAR FEATURES

- Custom fit to tire size
- Available in Black Denim and Dark Tan to match soft top
- Plastic molding center provides tight fit, a Mopar exclusive
- Plastic housing attachment secures behind the tire and carrier to prevent theft, if wheel is equipped with lock
- Jeep® logo
- High-quality YKK zippers, made of long-lasting acetyl resin, have a greater number of teeth and meet alignment and tolerance requirements
- Can be removed in minutes
- Flame-retardant fabric with backing
- Cover is made of a tough, vinyl-coated cotton/polyester blend and uses heavy-duty reinforced stitching
- Has been tested to withstand a variety of weather conditions
- Mopar Accessories are covered by either the 3-year/36,000-mile New Vehicle Limited Warranty, or the 12-month/12,000-mile Mopar Basic Limited Warranty, whichever is more favorable to the customer

COMPETITORS?*

- Is it a universal fit?
- Is it a loose or sloppy fit?
- Can it be easily stolen?
- Jeep logo is exclusive to DaimlerChrysler Corporation, Jeep and Mopar
- Are the zippers made of nylon?
- Do they have fewer teeth, enabling easier misalignment after repeated use?
- Does it take a long time to remove?
- Is the fabric flame retardant?
- Does it have a backing?
- Does the warranty compare?

*Check your market for your competitive situation.

INSTALLATION:

- Slips easily over spare tire
- Held in place with plastic anchor between tire and mount

COVERS, SPARE TIRE, DELUXE ANTITHEFT (CONT.)

Vehicle Line	MYO	MYI	Application Remarks	Part Number	Instl Time	Group	Sugg Retail Price
COVERS, SPARE TIRE — DELUXE ANTI-THEFT							
Wrangler	2001	1997	Tire Cover, Zippered Fabric for P235/70R16 or LT30x9.5x15	82206930	D.I.Y.	T	99.00
	2001	1997	Black Denim, for P205/75R15 tires, w/Black logo	82203430	D.I.Y.	T	76.00
	2001	1997	Black Denim, for P205/75R15 tires, w/White logo	82201692	D.I.Y.	T	76.00
	2001	1999	Tan, for P205/75R15 tires, w/Black logo	82204560	D.I.Y.	T	76.00
	2001	1999	Tan, for P215/75R15, tire, w/Black logo	82204561	D.I.Y.	T	76.00
	2001	1999	Tan, for P225/75R15, w/Black logo	82205492	D.I.Y.	T	76.00
	2001	1997	Black Denim, for P225/75R15 tires, w/Black logo	82203604	D.I.Y.	T	78.00
	2001	1999	Black Denim, for P225/70R16 tires	82205684	D.I.Y.	T	89.00
	2001	1999	Dark Tan, for P225/70R16 tires	82205685	D.I.Y.	T	89.00
	2001	1997	Black Denim, for LT30x9.5x15 tires, w/Black logo	82203433	D.I.Y.	T	99.00
	2001	1997	Black Denim, for LT30x9.5x15 tires, w/Silver logo	82202963	D.I.Y.	T	99.00
	2001	1997	Black Denim, for LT30x9.5x15 tires, w/White logo	82202341	D.I.Y.	T	99.00
	2001	1999	Tan, for LT30x9.5x15, w/Black logo	82204562	D.I.Y.	T	106.00

COVERS, CUSTOM DEALER IMPRINTED



Spare Tire Cover — Imprint available

Please see the Custom Dealer Imprinted Tire Cover order form in the front of the book.

Vehicle Line	MYO	MYI	Application Remarks	Part Number	Instl Time	Group	Sugg Retail Price
COVERS, SPARE TIRE, DEALER IMPRINT — ONE COLOR							
Wrangler	2001	1997	Black, economy fabric, P215/75R16 or P225/75R15	82203735	D.I.Y.	T	29.00
	2001	1997	Black Denim, P225/75R15	82203736	D.I.Y.	T	43.00
	2001	1997	Black economy fabric, LT30x9.5x15	82203376	D.I.Y.	T	43.00
	2001	1999	Tan Denim, P225/75R15	82204565	D.I.Y.	T	43.00
COVERS, SPARE TIRE, DEALER IMPRINT — THREE COLOR							
Wrangler	2001	1997	Black, economy fabric, P215/75R16 or P225/75R15	82203739	D.I.Y.	T	38.00
	2001	1997	Black Denim, P225/75R15	82203740	D.I.Y.	T	49.00
	2001	1997	Black, economy fabric, LT30x9.5x15	82203377	D.I.Y.	T	49.00
	2001	1999	Tan Denim, P225/75R15	82204566	D.I.Y.	T	49.00

COVERS, SPARE TIRE, FABRIC



Fabric Tire Cover

Please see the Custom Dealer Imprinted Tire Cover order form in the front of the book.

MOPAR FEATURES	COMPETITORS?*
<ul style="list-style-type: none"> • Fabric is the same as OE soft tops and is color matched • Available in Black Denim and Dark Tan • Available with or without Jeep® logo • Elastic band is sewn into the fabric, custom fit to tire size • Provides tight fit • Has been tested to withstand a variety of weather conditions • High-quality YKK zippers, made of long-lasting acetyl resin, have a greater number of teeth and meet alignment and tolerance requirements • Can be removed in minutes • Flame-retardant fabric with backing • Mopar Accessories are covered by either the 3-year/36,000-mile New Vehicle Limited Warranty, or the 12-month/12,000-mile Mopar Basic Limited Warranty, whichever is more favorable to the customer 	<ul style="list-style-type: none"> • Does the fabric meet DaimlerChrysler's standards for durability and color? • Jeep logo is exclusive to DaimlerChrysler Corporation, Jeep and Mopar • Does it flop around in the wind? • Are the zippers made of nylon? • Do they have fewer teeth, enabling easier misalignment after repeated use? • Does it take a long time to remove? • Is the fabric flame retardant? • Does it have a backing? • Does the warranty compare?

*Check your market for your competitive situation.

COVERS, SPARE TIRE, FABRIC (CONT.)

Vehicle Line	MYO	MYI	Application Remarks	Part Number	Instl Time	Group	Sugg Retail Price
COVERS, SPARE TIRE — FABRIC*							
Wrangler	2001	2000	Black Denim, for P225/75R15 tires, w/Smiley Face Logo	82206887	D.I.Y.	T	54.00
	2001	2000	Black, for LT30x9.5x15 or P225/70R16 tires w/Smiley Face Logo	82206893	D.I.Y.	T	54.00
	2001	2000	Spice Denim, for LT30x9.5x15 or P225/70R16 tire, w/Smiley Face Logo	82206897	D.I.Y.	T	54.00
	2001	2000	Spice Denim, for P225/75R15 tires, w/Spice Smiley Face Logo	82206891	D.I.Y.	T	54.00
	2001	2000	Tan Denim, for LT30x9.5R15 or P225/70R16 tires, w/Smiley Face Logo	82206895	D.I.Y.	T	54.00
	2001	2000	Tan Denim, for P225/75R15 tires - Tan w/Smiley Face Logo	82206889	D.I.Y.	T	54.00
	2001	1999	Tire Cover, Fabric, with Black Jeep logo, fits LT30x9.5x15 or 15LT or P225/70R16 tires	82206924	0.3	T	46.00
	2001	1999	Dark Grey Tire Cover, Fabric, with Black Jeep logo, fits P215/75R16 and P225/75R15	82206923	0.3	T	46.00
	2001	1997	Black Denim Tire Cover, Fabric with Grey Jeep logo, P235/70R16 and LT30x9.5x15	82206928	D.I.Y.	T	46.00
	2001	1997	Black Denim Tire Cover, Fabric, with Grey Jeep logo, P215/75R16 and P225/75R15	82206927	D.I.Y.	T	46.00
	2001	1997	Black Denim Tire Cover, Fabric, with White Jeep logo, P235/70R16 and LT30x9.5x15	82206926	D.I.Y.	T	46.00
	2000	1997	Black, fits LT30x9.5x15	82204516	D.I.Y.	T	41.25
	2001	1997	Black, fits P215 or P225/75R15	82203729	D.I.Y.	T	42.00
	2001	1999	Tan, fits P215 or P225/75R15	82204563	D.I.Y.	T	42.00
	2001	1997	Black, fits P215 or P225/75R15	82204514	D.I.Y.	T	44.25
	2001	1999	Tan, fits P215 or P225/75R15	82204568	D.I.Y.	T	44.25
	2001	1997	Black, fits P215 or P225/75R15	82203732	D.I.Y.	T	46.00
	2001	1999	Tan, fit P215 or P225/75R15	82204564	D.I.Y.	T	46.00
	2000	1999	Tan, fits LT30x9.5x15	82204569	D.I.Y.	T	50.00
	2001	1999	Tan, fits LT30x9.5x15	82204567	D.I.Y.	T	52.00

*NOTE: These tire covers are tailored to be a tight fit, if a customer desires a slightly looser and easier installation, order next largest tire size cover.

COVERS, SPARE TIRE, PREMIUM HARD COVER



Premium Hard Cover
(shown on Wrangler)

MOPAR FEATURES	COMPETITORS?*
<ul style="list-style-type: none"> • Offered for all Wrangler tire sizes • Constructed of high-impact weatherable thermoplastic and vinyl • Resistant to road chemicals, sunlight and temperature extremes, it can survive even the harshest of conditions • Includes a provision for a lock and cable to help prevent theft • Mopar Accessories are covered by either the 3-year/36,000-mile New Vehicle Limited Warranty, or the 12-month/12,000-mile Mopar Basic Limited Warranty, whichever is more favorable to the customer 	<ul style="list-style-type: none"> • Is it a universal fit? • Does the warranty compare?

*Check your market for your competitive situation.

INSTALLATION:

- Installs quickly and easily
- No tools required

Vehicle Line	MYO	MYI	Application Remarks	Part Number	Instl Time	Group	Sugg Retail Price
COVERS, SPARE TIRE — PREMIUM HARD COVER							
Wrangler	2001	1997	Black, fits LT30x9.5x15	82204862	0.3	T	129.00
	2001	1997	Black, fits P205/75R15	82204935	0.3	T	129.00
	2001	1997	Black, fits P215/75R15	82204858	0.3	T	129.00
	2001	1997	Black, fits P225/75R15	82204860	0.3	T	129.00
	2001	1999	Dark Tan w/Black Jeep logo, fits P215/75R15	82204859	0.3	T	129.00
	2001	1999	Tan, fits LT30x9.5x15	82204863	0.3	T	129.00
	2001	1999	Tan, fits P205/75R15	82204936	0.3	T	129.00
	2001	1999	Tan, fits P225/75R15	82204861	0.3	T	129.00

COVERS, VEHICLE



Full Vehicle Cover (shown on Ram Pickup)



Cherokee



Voyager



Cab Cover (shown on Ram Pickup)



PT Cruiser



Prowler



Viper



Neon

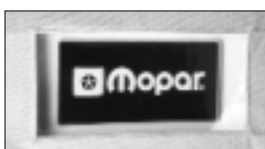

With license plate window

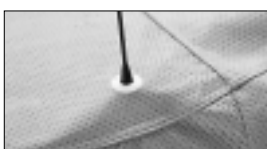

Antenna grommet



Mirror Pocket



Ram's Head logo

MOPAR FEATURES

- Custom designed for vehicle's unique shape
- Double stitched with an elastic bottom
- Includes custom-fit mirror pockets
- Includes antenna and tie-down grommets, and clear license plate window
- Premium quality Block-IT™ material is tough, lightweight and water resistant
- Protects finish from sun, dirt, pollutants and acid rain
- Cleans easily
- Silk-screened Mopar or vehicle logo
- Mopar Accessories are covered by either the 3-year/36,000-mile New Vehicle Limited Warranty, or the 12-month/12,000-mile Mopar Basic Limited Warranty, whichever is more favorable to the customer

COMPETITORS?*

- Is it a custom fit?
- Is it water resistant?
- Does it have fitted mirror pockets?
- Does it have license plate window, or antenna and tie-down grommets?
- Is it a poly-cotton or nylon material?
- Mopar logo is exclusive to DaimlerChrysler Corporation and Mopar
- Does the warranty compare?

*Check your market for your competitive situation. Block-IT is a trademark of Kimberly-Clark Corporation.

INSTALLATION:

Easily installed or removed

COVERS, VEHICLE (CONT.)

Vehicle Line	MYO	MYI	Application Remarks	Part Number	Instl Time	Group	Sugg Retail Price
COVERS, VEHICLE							
Avenger, Sebring Coupe	2000	1997	Gray, Block-IT™ material w/license plate window and mirror pockets, custom fit	82206329	D.I.Y.	T	210.00
Avenger, Sebring Coupe, Breeze, Cirrus, Stratus, Sebring Sedan, Stratus Sedan, Sebring Convertible, Sebring Coupe, Stratus Coupe	2001	1995	Gray, Block-IT material, w/license plate window and mirror pockets	82206329	D.I.Y.	T	198.00
Cherokee, Grand Cherokee	2001	1984	Gray, Block-IT-400 material w/mirror pockets	82206150	D.I.Y.	T	225.00
Concorde, Intrepid, LHS, 300M	2001	1998	Gray, Block-IT material, w/license plate window and mirror pockets, custom fit	82206212	D.I.Y.	T	210.00
	2001	1998	Gray, Block-IT material w/license plate window and mirror pockets, custom fit	82206213	D.I.Y.	T	215.00
Dakota (All)	2001	1997	Regular Cab, 8.0 ft. bed, custom fit, Gray, Block-IT material w/mirror pockets, antenna grommet, license plate window	82202722	D.I.Y.	T	143.00
Dakota Club Cab	2001	1997	Gray, Club Cab, 6.5 ft. bed, Block-IT-400 material, w/mirror pockets, antenna grommet, license plate window	82206148	D.I.Y.	T	240.00
Dakota Regular Cab	2001	1997	Gray, Regular Cab, 6.5 ft. bed, Block-It material w/mirror pockets, antenna grommet, license plate window	82206147	D.I.Y.	T	240.00
Durango	2001	1998	Block-IT-400 material, w/license plate window, mirror pockets, antenna grommet and Ram's head logo	82206149	D.I.Y.	T	240.00
Minivan (All)	2001	1996	Gray, Block-IT material, mirror pockets and license plate window	82206218	D.I.Y.	T	225.00
Minivan (SWB Only)	2001	1996	Gray, Block-IT material, w/license plate window and mirror pockets	82206217	D.I.Y.	T	225.00
Neon	2001	2000	Gray, Block-IT material, w/license plate window and mirror pockets	82206219	D.I.Y.	T	198.00
Prowler	2001	1998	Block-IT material, w/license plate window, purple-embroidered Prowler logo and storage bag	82206215	D.I.Y.	T	155.00
PT Cruiser	2001	2001	Gray, Block-IT material w/license plate window and mirror pockets	82205450	D.I.Y.	T	193.00
Ram 1500 Van or Wagon SWB	2001	1994	Gray, Block-IT material w/mirror pockets, Short wheelbase	82301022	D.I.Y.	T	290.00
Ram 1500/2500 - Quad Cab w/6.5' Bed	2001	1998	Gray, Cab and 6.5 ft. Bed Cover, Block-IT material	82206154	D.I.Y.	T	260.00
Ram 3500 Quad Cab	2000	1998	Gray, Cab and 8.0 ft Bed Cover, dually, Technalon material	82401387	D.I.Y.	T	285.00
Ram Pickup - Club or Quad Cab	2001	1998	Gray, cab only, Block-IT-400 material, w/Mopar logo and storage bag	82206153	D.I.Y.	T	200.00
	2001	1998	Gray, Block-IT-400 material, cab and bed cover, w/Mopar logo and storage bag	82206156	D.I.Y.	T	285.00

Block-IT is a registered trademark of Kimberley-Clark Corporation.

COVERS, VEHICLE (CONT.)

Vehicle Line	MYO	MYI	Application Remarks	Part Number	Instl Time	Group	Sugg Retail Price
COVERS, VEHICLE (CONT.)							
Ram Pickup - Regular Cab (All)	2001	1994	Gray, Block-IT-400™ material, cab and bed cover, w/storage bag	82206152	D.I.Y.	T	225.00
Ram Quad Cab w/8.0' Bed	2001	1998	Gray, Block-IT-400 material, cab and bed cover, w/Mopar logo and storage bag	82206155	D.I.Y.	T	280.00
Ram Regular Cab w/6.5' Bed	2000	1994	Gray, Cab and 6.5 ft. Bed Cover, Block-IT material, w/standard cab, bag not included	82206152	D.I.Y.	T	220.00
Ram Regular Cab w/8.0' Bed	2001	1994	Gray, Cab and 8.0 ft. Bed Cover, Technalon material	82400992	D.I.Y.	T	245.00
Ram Van or Wagon LWB	2001	1994	Gray, Block-IT material w/mirror pockets, long wheelbase	82301023	D.I.Y.	T	290.00
Sebring Convertible	2000	1996	Gray, Block-IT material w/license plate window and mirror pockets	82206220	D.I.Y.	T	190.00
	2001	2001	Vehicle Cover, Gray, Block-It material, w/ license plate window and mirror pockets, custom fit	82206330	D.I.Y.	T	198.00
Viper RT/10	2001	1993	Block-IT material, w/license plate window, mirror pockets, rear exhaust heat shield and blue embroidered Viper logo	82206211	D.I.Y.	T	225.00
	2000	1993	Gray, w/license plate window, mirror pockets, rear exhaust heat shield, red embroidered Viper logo and storage bag	82202275	D.I.Y.	T	210.00
Viper GTS	2001	1997	Gray, Block-It material w/license plate window, mirror pockets, rear exhaust heat shield, red embroidered Viper logo and storage bag; custom fit	82206216	D.I.Y.	T	230.00
Wrangler	2000	1997	Gray, w/license plate window, mirror pockets, w/ Jeep logo in black	82202213	D.I.Y.	T	220.00
	2001	1997	Gray, Block-IT-400 material, w/Jeep logo, mirror pockets and license plate window	82206146	D.I.Y.	T	225.00

Block-IT 400 is a registered trademark of Kimberley-Clark Corporation.

DIESEL ENGINE FAN CLUTCHES

Vehicle Line	MYO	MYI	Application Remarks	Part Number	Instl Time	Group	Sugg Retail Price
DIESEL ENGINE FAN CLUTCHES							
Ram Pickup (All)	2001	1995	End wrench, required for installation of Fan Clutch on Cummins Turbo Diesel	82202283	D.I.Y.	T	24.50
	2001	1994	All diesel engines, electromagnetic fan clutch, allows engine to run cooler, longer and more efficient	82205124	3.0	T	770.00

DIESEL EXHAUST BRAKES

MOPAR FEATURES	COMPETITORS?*
<ul style="list-style-type: none"> • Designed in conjunction with Cummins Engine Company, Inc. and DaimlerChrysler Corporation • Produces maximum retarding horsepower at rated speed • Illuminated on/off switch comes with kit • No major vehicle modification required • Mopar Accessories are covered by either the 3-year/36,000-mile New Vehicle Limited Warranty or the 12-month/12,000-mile Mopar Basic Limited Warranty, whichever is more favorable to the customer 	<ul style="list-style-type: none"> • Does the warranty compare?

*Check your market for your competitive situation.

INSTALLATION:

- Complete kit with thorough instructions
- Easy installation
- Manual transmission vehicles only

Vehicle Line	MYO	MYI	Application Remarks	Part Number	Instl Time	Group	Sugg Retail Price
DIESEL EXHAUST BRAKES							
Ram 2500/3500 (All)	2001	1998	With Cummins ISB 5.9L 24-valve Intercooled Turbo Diesel engine with manual transmission only	82205577	3.0		675.00

DOOR EDGE GUARDS



With bodyside molding (shown on Ram Pickup)



Without bodyside molding (shown on Dakota)



Door Edge Guards with black vinyl laminate



Door Edge Guard with black vinyl laminate

MOPAR FEATURES	COMPETITORS?*
<ul style="list-style-type: none"> • Custom fit to door edge contours • Protect door edges against paint chipping • Retains appearance • Stainless steel with black vinyl laminate to protect vehicle paint during installation • Rust-resistant • Mopar Accessories are covered by either the 3-year/36,000-mile New Vehicle Limited Warranty, or the 12-month/12,000-mile Mopar Basic Limited Warranty, whichever is more favorable to the customer 	<ul style="list-style-type: none"> • Is it a universal fit, not cut to exact door sizes? • Is it metal-on-metal construction that may cause damage during installation? • Does the warranty compare?

*Check your market for your competitive situation.

INSTALLATION:

- No tools required for installation
- Packaged in full sets for 2- or 4-door models

DOOR EDGE GUARDS (CONT.)

Vehicle Line	MYO	MYI	Application Remarks	Part Number	Instl Time	Group	Sugg Retail Price
DOOR EDGE GUARDS							
Cherokee 2-Door	2001	1997	Black, stainless steel w/ vinyl laminate, set of 2	82203381	D.I.Y.	T	18.50
Cherokee 4-Door	2001	1997	Black, stainless steel w/ vinyl laminate, set of 4	82203382	D.I.Y.	T	18.50
Cirrus LXi	2000	1995	Black, stainless steel w/ vinyl laminate, set of 4	82300912	D.I.Y.	T	30.75
Concorde, LHS	2001	1998	Black, stainless steel w/ vinyl laminate, set of 4	82203638	D.I.Y.	T	33.00
Dakota (All)	2001	1997	Black, stainless steel w/ vinyl laminate, set of 2 (for Quad Cab, order 2nd set)	82202760	D.I.Y.	T	20.00
Durango	2001	1998	Black, stainless steel w/ vinyl laminate, set of 4 (does not fit rear doors on vehicles equipped w/ wheel flares)	82203671	D.I.Y.	T	33.00
Grand Cherokee	2001	1999	Black, stainless steel w/ vinyl laminate, set of 4	82206378	D.I.Y.	T	38.00
Intrepid	2001	1998	Black, stainless steel w/ vinyl laminate, set of 4	82203637	D.I.Y.	T	33.00
LHS, 300M	2001	1998	Black, stainless steel w/ vinyl laminate, set of 4	82203639	D.I.Y.	T	33.00
Minivan (All)	2000	1996	Black, front doors only, vinyl laminate, set of 2	82300967	D.I.Y.	T	18.25
	2001	2001	Black vinyl, for minivans w/cladding	82206336	D.I.Y.	T	26.00
	2001	2001	Black, stainless steel w/ vinyl laminate, set of 2, front doors only, for vehicles w/o cladding	82206388	D.I.Y.	T	26.00
Neon	2001	2000	Black, stainless steel w/ vinyl laminate, set of 4	82204789	D.I.Y.	T	33.00
PT Cruiser	2001	2001	Black, stainless steel w/ vinyl laminate, set of 4	82205454	D.I.Y.	T	35.00
Ram Pickup (All)	2001	1994	Black, stainless steel w/ vinyl laminate, set of 2	82205362	D.I.Y.	T	16.00
Sebring Convertible	2001	2001	Black, stainless steel w/ vinyl laminate, set of 2 for convertible	82206019	D.I.Y.	T	18.25
	2000	1996	Black, stainless steel w/ vinyl laminate, set of 2	82202055	D.I.Y.	T	18.25
Sebring Sedan, Stratus Sedan	2001	2001	Black, stainless steel w/ vinyl laminate, set of 4	82205967	D.I.Y.	T	26.00
Stratus	2000	1995	Black, stainless steel w/ vinyl laminate, set of 4	82300960	D.I.Y.	T	30.75
Wrangler	2001	1997	Black, stainless steel w/ vinyl laminate, set of 2, w/ full hard door	82202393	D.I.Y.	T	20.00
SCRATCH GUARDS-DOOR/HATCH HANDLES							
PT Cruiser	2001	2001	Scratch Guards - Door Handle/Hatch Handle	82206326	0.3	T	20.00
	2001	2001	Step Pad - rear bumper, black, textured, installs w/3M Adhesive	82205445	0.2	T	24.00

DOOR ENTRY GUARDS

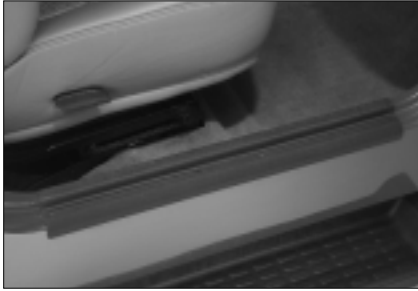

Door Entry Guards (shown on Wrangler)



Ram



Dakota

MOPAR FEATURES	COMPETITORS?*
<ul style="list-style-type: none"> • Custom-molded to fit vehicle's door sill • Available in black polypropylene • Adhesive tape installation, no drilling (except Viper) • Stainless steel features etched logo (Wrangler only) • Mopar Accessories are covered by either the 3-year/36,000-mile New Vehicle Limited Warranty, or the 12-month/12,000-mile Mopar Basic Limited Warranty, whichever is more favorable to the customer 	<ul style="list-style-type: none"> • Is it a universal fit? • Does it require screws to install? • Jeep logo is exclusive to DaimlerChrysler Corporation, Jeep and Mopar • Does the warranty compare?

*Check your market for your competitive situation.

INSTALLATION:

Attaches with DaimlerChrysler-approved adhesive tape (except Viper)

Vehicle Line	MYO	MYI	Application Remarks	Part Number	Instl Time	Group	Sugg Retail Price
DOOR ENTRY GUARDS							
Concorde, Intrepid, LHS, 300M	2001	1998	Black, plastic	82204466	0.2	T	31.00
Dakota (All)	2001	1997	Black, plastic, w/Rams Head Logo	82202759	0.2	T	21.00
Dakota Quad Cab	2001	2000	Black, plastic, w/Rams Head Logo, 4-Door	82203728	0.2	T	33.00
Durango	2001	1998	Black, plastic, w/Rams Head Logo, 4-Door	82203728	0.2	T	33.00
Minivan (All)	2001	2001	Stainless Steel	82205915	0.2	T	69.00
	2001	2001	Stainless Steel	82206528	0.2	T	69.00
Ram Pickup - Club or Quad Cab	2001	1998	Black, plastic, w/Rams Head logo, 4-door	82204880	0.2	T	23.00
Ram Pickup - Regular Cab (All)	2001	1994	Black, plastic, w/Rams Head logo	82401199	0.2	T	21.00
Viper	2000	1992	Door Entry Guards, Black, plastic w/Viper logo	82204427	0.2	T	60.50
Wrangler	2001	1997	Black plastic, may also require J4005678 shim to raise door	82202297	0.2	T	21.00
	2001	1997	Stainless steel, w/etched Jeep logo, may also require J40055678 shim to raise door	82204262	0.2	T	69.00

ENGINE BLOCK & BATTERY HEATERS/POWER OUTLET RELAY



Engine Block Heater



Battery Heater

MOPAR FEATURES	COMPETITORS?*
<p>Engine Block Heater</p> <ul style="list-style-type: none"> • Special plug-in wiring designed for each application • Designed and engineered for each vehicle, same as production vehicle heaters • Keeps engine warm for easier starting, quicker warm-up • Warm air from heater at start-up • 400 watts 4-cyl, 600 watts V6 <p>Battery Blanket</p> <ul style="list-style-type: none"> • Durable, fire-retardant vinyl construction resists oils and acids • Fiberglass insulation retains heat on battery case • Electrically warms battery • Extends battery life • Prevents loss of starting power due to cold temperature • 80-watt heater • Mopar Accessories are covered by either the 3-year/36,000-mile New Vehicle Limited Warranty, or the 12-month/12,000-mile Mopar Basic Limited Warranty, whichever is more favorable to the customer 	<p>Engine Block Heater</p> <ul style="list-style-type: none"> • Is the plug-in harness a universal length? • Has the heater been designed, engineered and fitted for your specific engine, or is it a universal fit? • Does the warranty compare? <p>Battery Blanket</p> <ul style="list-style-type: none"> • Is it made from less durable material? • Will it resist oils and acids? • Is it insulated? • Does the warranty compare?

*Check your market for your competitive situation.

INSTALLATION:

- Same as production heater (Engine Block Heater)
- Dealer installation recommended (Engine Block Heater)
- Easily installed (Battery Heater)
- Plugs into any standard 110/120-volt outlet

Vehicle Line	MYO	MYI	Application Remarks	Part Number	Instl Time	Group	Sugg Retail Price
BATTERY BLANKET							
Cherokee, Grand Cherokee, Wrangler	2001	1993	Fits batteries w/28" to 36" circumference	82300778	0.3	T	33.00
Durango, Ram Pickup	2001	1993	Fits batteries w/28" to 36" circumference	82300778	0.3	T	33.00
Minivan (All)	2001	1993	Fits batteries w/28" to 36" circumference	82300778	0.3	T	33.00
Passenger Cars (All)	2001	1993	Fits batteries w/28" to 36" circumference	82300778	0.3	T	33.00
Ram Van/Wagon, Dakota (All)	2001	1993	Fits batteries w/28" to 36" circumference	82300778	0.3	T	33.00

ENGINE BLOCK HEATER (CONT.)

Vehicle Line	MYO	MYI	Application Remarks	Part Number	Instl Time	Group	Sugg Retail Price
ENGINE BLOCK HEATERS							
Avenger, Sebring Coupe, Neon	2000	1995	4-cyl, includes Battery Blanket and combination power cord	82300776	1.0	T	59.50
Avenger, Sebring Coupe	2000	1995	6-cyl, includes Battery Blanket and combination power cord	82300777	1.0	T	59.50
Avenger, Sebring Coupe, Breeze, Cirrus, Stratus	2000	1995	2.4L 4-cyl	82202500	0.6	T	33.00
Breeze, Cirrus, Stratus, Sebring Convertible	2000	1995	6-cyl 3.0L, 3.3L, 3.8L, 3.9L; V-8 5.2L, 5.9L; V-10 8.0L	82300749	0.6	T	33.00
Cherokee, Grand Cherokee, Wrangler	2001	1987	4.0L Power Tech I-6	82201506	0.6	T	33.00
Cherokee, Wrangler	2001	1987	4-cyl, 2.5L	82201505	0.6	T	33.00
Concorde, Intrepid, LHS, 300M	2001	1998	2.7L, 3.2L, 3.5L, includes Battery Blanket and combination power cord	82203641	1.0	T	78.00
Dakota (All)	2001	1996	4-cyl, 2.5L	82201505	0.6	T	33.00
	2001	2000	4.7L V8	82203640	0.6	T	33.00
Durango	2001	1999	4.7L V8	82203640	0.6	T	33.00
Durango, Ram Pickup	2001	1994	6-cyl 3.0L, 3.3L, 3.8L, 3.9L; V-8 5.2L, 5.9L; V-10 8.0L	82300749	0.6	T	33.00
Grand Cherokee	2001	1999	4.7L V8	82203640	0.6	T	33.00
Minivan (All)	2000	1996	2.4L 4-cyl	82202500	0.6	T	33.00
	2000	1996	6-cyl 3.0L, 3.3L, 3.8L, 3.9L; V-8 5.2L, 5.9L; V-10 8.0L	82300749	0.6	T	33.00
	2001	2001	V6 All	82206844	0.6	T	33.00
	2001	2001	2.4L Engine	82206843	0.6	T	33.00
PT Cruiser	2001	2001	2.4L DOHC	82206785	1.0	T	33.00
Ram Van/Wagon, Dakota (All)	2001	1993	6-cyl 3.0L, 3.3L, 3.8L, 3.9L; V-8 5.2L, 5.9L; V-10 8.0L	82300749	0.6	T	33.00
Sebring Sedan & Conv., Stratus Sedan	2001	2001	Engine Block Heater, Battery Blanket and combination Power Cord, 2.7L, V6	82206784	1.0	T	78.00
	2001	2001	Engine Block Heater, Battery Blanket, and combination Power Cord, 2.4L, DOHC, 4-cyl	82206642	1.0	T	78.00

EVS® SYSTEMS, QUICK REFERENCE

GUIDE TO SELECTING YOUR EVS I® ELECTRONIC VEHICLE SECURITY AND KEYLESS ENTRY SYSTEM

Use the chart below to choose from five distinct systems designed to meet your individual needs. Then check out the specific features and benefits of the system that best suits your lifestyle.

System: Vehicle Equipment:	EVS Security System Vehicles without power locks	EVS II Security System Vehicles equipped with factory-installed power locks	EVS II Security Plus Vehicles equipped with factory-installed power locks and keyless entry	Keyless Entry System Vehicles equipped with factory-installed power locks	IT-s™ Vehicles with factory security system
System Benefit:	Adds security system feature to your vehicle	Adds security system and remote keyless entry	Adds security system feature to your vehicle	Adds remote keyless entry feature to your vehicle	Adds shock sensor

MOPAR FEATURES	THE COMPETITION?*
<ul style="list-style-type: none"> • Engineered by Mopar for each DaimlerChrysler Corporation vehicle • Toll-free technical hot line • Tested to ensure no RFI interference with vehicle's electronic system • Low vehicle ignition-off current draw with EVS • Starter interrupt immobilizes vehicle when triggered • Mopar Accessories are covered by either the 3-year/36,000-mile New Vehicle Limited Warranty, or the 12-month/12,000-mile Mopar Basic Limited Warranty, whichever is more favorable to the customer 	<ul style="list-style-type: none"> • Is it one size fits all? • Is there a national hot line for field support? • Are crimp connectors required for installation? • Will wires vibrate loose? • Will it affect the engine control computer or other vehicle electrical systems? • Will it cause false triggering? • Will it draw excess current or cause a dead battery? • Does alarm just "make noise?" • Does the warranty compare?

*Check your market for your competitive situation.

NOTE: If vehicle is under warranty and a replacement module or siren is needed, call (800) 84-MOPAR for warranty replacements. Have EMCR and vehicle information ready. If customer pays, order:

- 5012164AA for EVS Base module and 82203198 for replacement siren
- 4883255 for EVS II System module, 82203198 for replacement siren and 4883207 for keyless entry system module
- 5011649AA for EVS Plus module and siren, and 4883287 for keyless entry system module



EVS Base Security System

EVS BASE SECURITY SYSTEM For Vehicles Without Power Door Locks

Enjoy the convenience and protection of electronic vehicle security at an affordable price! Specifically designed for Dodge trucks without power door locks.

FEATURES:

- Instrument panel warning light
- Warning siren
- Two remote transmitters
- Remote control arm/disarm
- Starter interrupt
- Remote control panic alarm
- Automatic rearming
- Illuminated entry
- Programmable passive or active security arming
- Valet mode

OPTIONAL FEATURES INCLUDE:

- Dual-stage shock/impact sensor
- 30-second headlamp illumination with flashing parking lamps
- Additional remote transmitters

INSTALLATION:

- Comprehensive illustrated installation manual, Owner's Manual and wallet card
- Complete technical support offered at (800) 34-MOPAR

EVS® SYSTEMS, EVS BASE SECURITY SYSTEM (CONT.)

Vehicle Line	MYO	MYI	Application Remarks	Part Number	Instl Time	Group	Sugg Retail Price
EVS SYSTEMS, EVS BASE SYSTEM*†							
Breeze, Cirrus, Stratus	2000	1995	EVS Base System for vehicles w/o power locks, Includes: 2 remote transmitters, siren and starter interrupt; optional shock sensor available (PN 04886260AB)	82203763	D.I.Y.	7	180.00
Cherokee, Wrangler	2001	1995	EVS Base System for vehicles w/o power locks, Includes: 2 remote transmitters, siren and starter interrupt; optional shock sensor available (PN 04886260AB)	82203763	D.I.Y.	7	180.00
Minivan (All)	2001	1996	EVS Base System for vehicles w/o power locks, Includes: 2 remote transmitters, siren and starter interrupt; optional shock sensor available (PN 04886260AB)	82203763	D.I.Y.	7	180.00
Neon, PT Cruiser	2001	1995	EVS Base System for vehicles w/o power locks, Includes: 2 remote transmitters, siren and starter interrupt; optional shock sensor available (PN 04886260AB)	82203763	D.I.Y.	7	180.00
Dakota, Ram Pickup (All)	2001	1994	EVS Base System for vehicles w/o power locks, Includes: 2 remote transmitters, siren and starter interrupt; optional shock sensor available (PN 04886260AB)	82203763	D.I.Y.	7	180.00
Ram Van/Wagon	2001	1994	EVS Base System for vehicles w/o power locks, Includes: 2 remote transmitters, siren and starter interrupt; optional shock sensor available (PN 04886260AB)	82203763	D.I.Y.	7	180.00
WIRING PACKAGES FOR EVS BASE SYSTEM*							
Breeze, Cirrus, Stratus	2000	1995	Wiring Package for EVS Base Security System Use w/PN 82203763, for vehicles w/o power locks	82203764	2.0		35.00
Cherokee	2001	1994	Wiring Package for EVS Base Security System Use w/PN 82203763 for vehicle w/o power locks	82203764	2.0		35.00
Dakota (All)	2001	2001	Wiring Package for EVS Base Security System Use w/PN 82203763 for vehicle w/o power locks	82206771	2.0		TBD
	2000	1994	Wiring Package for EVS Base Security System Use w/PN 82203763 for vehicle w/o power locks	82203765	2.0		38.00
Minivan (All)	2001	2001	Wiring Package for EVS Base Security System Use w/PN 82203763 for vehicle w/o power locks	82206637	2.0		30.00
	2000	1996	Wiring Package for EVS Base Security System Use w/PN 82203763, for vehicles w/o power locks	82203764	2.0		35.00
Neon	2001	2000	Wiring Package for EVS Base Security System Use w/PN 82203763 for vehicle w/o power locks	82205189	2.0		38.00
PT Cruiser	2001	2001	Wiring Package for EVS Base Security System Use w/PN 82203763 for vehicle w/o power locks	82206015	2.0		35.00
Ram Pickup (All)	2001	1994	Wiring Package for EVS Base Security System Use w/PN 82203763 for vehicle w/o power locks	82203765	2.0		38.00
Ram Van/Wagon	2001	2001	Wiring Package for EVS Base Security System Use w/PN 82203763 for vehicle w/o power locks	82206770	2.0		TBD
	2000	1998	Wiring Package for EVS Base Security System Use w/PN 82203763 for vehicle w/o power locks	82203766	2.0		38.00
Wrangler	2000	1997	Wiring Package for EVS Base Security System Use w/PN 82203763 for vehicle w/o power locks	82203162	2.0		52.00
	2001	2001	Wiring Package for EVS Base Security System Use w/PN 82203763 for vehicle w/o power locks	82206768	2.0		52.00

*EVS is a registered trademark of DaimlerChrysler.

†NOTE: If vehicle is under warranty and a replacement module or siren is needed, call 1-800-34-MOPAR for warranty replacement. Have EMCR and vehicle information ready. If customer pay, order 5012164AA for EVS Base Module and 82203198 for replacement siren.

EVS® SYSTEMS, EVS II® IT-s (INTERIOR THEFT SENSOR)



EVS II IT-s

EVS II IT-s (INTERIOR THEFT SENSOR)

For Vehicles With a Factory-Installed Security System

Designed for vehicles equipped with a factory-installed security system, the IT-s uses infrared technology to protect the contents of your vehicle. The IT-s offers:

- Interior vehicle content protection; while factory security systems help prevent vehicles from being stolen, the IT-s guards against vehicle tampering, towing, theft of parts, accessories and contents
- Improved impact-sensing for total vehicle protection, even at areas far away from the sensor like the trunk and tires
- Virtual elimination of false alarms caused by external factors such as sound, radio frequency interference, and moisture or temperature changes
- Low current draws, critical in preventing dead batteries because sensors do their most important work when the car is turned off
- Wide range of sensitivity, so it can be individually adjusted for optimum performance on any vehicle

Vehicle Line	MYO	MYI	Application Remarks	Part Number	Instl Time	Group	Sugg Retail Price
EVS II INTERIOR THEFT SENSOR (IT-s)*							
Concorde, Intrepid, LHS, 300M	2001	1998	Complete kit w/infrared shock sensor and wiring	82205192	0.4	7	130.00
Durango	2000	1998	Complete kit w/infrared shock sensor and wiring	82205817	0.4	7	130.00
Durango, Dakota	2001	2001	Complete kit w/infrared shock sensor and wiring	82206940	0.4	7	130.00
Grand Cherokee	2001	1999	Complete kit w/infrared shock sensor and wiring	82204688	0.2	7	130.00
Minivan (All)	2001	2001	Complete Kit w/ infrared shock sensor and wiring	82206640	0.5	7	130.00
	2000	1998	Complete kit w/infrared shock sensor and wiring	82205193	0.5	7	130.00
Neon	2001	2000	Complete kit w/infrared shock sensor and wiring	82205190	0.6	7	130.00
PT Cruiser	2001	2001	Complete kit w/infrared shock sensor and wiring	82206016	0.6	7	130.00
Sebring Sedan & Conv., Stratus Sedan	2001	2001	Complete kit w/infrared shock sensor and wiring	82206774	0.6	7	130.00

*EVS II and IT-s are registered trademarks of DaimlerChrysler.



EVS II Security System

EVS II – ELECTRONIC VEHICLE SECURITY SYSTEM
For Vehicles With Power Door Locks

Offers state-of-the-art electronic security for Dodge trucks with power door locks and without a factory-installed remote keyless entry system. Protects both your vehicle and its contents.

FEATURES:

- Dual-stage shock/impact sensor
- Remote control door lock/unlock
- Programmable lock/unlock with ignition
- Instrument panel warning light
- Warning siren
- Two remote transmitters
- Remote control arm/disarm
- Starter interrupt

- Remote control panic alarm
- Automatic rearming
- Illuminated entry
- Programmable passive or active security arming
- Valet mode

In addition, optional features include:

- 30-second headlamp illumination with flashing parking lamps
- Additional remote transmitters

INSTALLATION:

- Custom-designed, color-coded, plug-in wiring harness
- Complete technical support, including a toll-free technical hot line: (800) 34-MOPAR

Vehicle Line	MYO	MYI	Application Remarks	Part Number	Instl Time	Group	Sugg Retail Price
EVS SYSTEMS, EVS II SECURITY SYSTEM**							
Breeze, Cirrus, Stratus, Sebring Convertible	2000	1995	EVS II Security System For Vehicles with Power Locks, w/o Keyless Entry Includes: 2 remote transmitters, siren, starter interrupt and shock sensor.	82300985	D.I.Y.	7	265.00
Minivan (All)	2001	1996	EVS II Security System For Vehicles with Power Locks, w/o Keyless Entry Includes: 2 remote transmitters, siren, starter interrupt and shock sensor.	82300985	D.I.Y.	7	265.00
Ram Pickup (All)	2001	1994	EVS II Security System For Vehicles with Power Locks, w/o Keyless Entry Includes: 2 remote transmitters, siren, starter interrupt and shock sensor.	82300985	D.I.Y.	7	265.00
	2001	1999	BIG SHOOTER EVS II Security System - For Vehicles with Power Locks, w/o Keyless Entry. Kit includes: wiring harness and headlight illumination. You must order at least 50.	82205822	3.0		305.00
WIRING PACKAGES FOR EVS II SECURITY SYSTEM*							
Breeze, Cirrus, Stratus, Sebring Convertible	2000	1995	Wiring Package for EVS II Security System or Keyless Entry System Use w/PNs 82300985 and 82300986, w/o power trunk option and Power Door Locks	82202437 [†]	3.0		50.00
Minivan (All)	2001	2001	Wiring Package for EVS II Security System or Keyless Entry Use w/PN 82300985 or 82300986 for vehicle w/power locks	82206638 [†]	3.0		32.00
	2000	1996	Wiring Package for EVS II Security System or Keyless Entry Use w/PN 82300985 or 82300986 for vehicle w/power locks	82202441 [†]	3.0		50.00
Ram Pickup (All)	2001	1999	Wiring Package for EVS II Security System or Keyless Entry Use w/PN 82300985 or 82300986 for vehicle w/power locks	82204681 [†]	3.0		52.00

*EVS II is a registered trademark of DaimlerChrysler.

**NOTE: If vehicle is under warranty and a replacement module or siren is needed, call 1-800-34-MOPAR for warranty replacement. Have EMCR and vehicle information ready. If customer pay, order 4883255 for EVS System II Module, order 82203190 for replacement siren and 4883287 for Keyless Entry System Module.

†NOTE: EVS II Security System cannot be used with OE Security Systems.



EVS II Security Plus System



Remote Transmitter

EVS II SECURITY PLUS For Vehicles With Factory- Installed Keyless Entry Systems

Turns your factory-installed keyless entry system into an advanced electronic security system. Taking advantage of this upgrade is an easy and economic way to protect your vehicle and its contents. Using your existing keyless entry transmitter, you can access these added security features:

FEATURES:

- Flashing parking lamps
- Dual-stage shock/impact sensor
- Instrument panel warning light
- Warning siren
- Remote control arm/disarm
- Starter interrupt
- Programmable passive or active security arming
- Valet mode
- Complete technical support offered at (800) 34-MOPAR

INSTALLATION:

- Comprehensive illustrated, installation manual; Owner's Manual and wallet card
- Complete technical support, including toll-free technical hot line: (800) 34-MOPAR
- Custom-designed, color-coded plug-in Wiring Harness

EVS® SYSTEMS, EVS II® SECURITY PLUS SYSTEM (CONT.)

Vehicle Line	MYO	MYI	Application Remarks	Part Number	Instl Time	Group	Sugg Retail Price
EVS SYSTEMS, EVS II SECURITY PLUS SYSTEM*							
Breeze, Cirrus, Stratus, Sebring Sedan, Stratus Sedan, Sebring Conv., Concorde, Intrepid, LHS, 300M	2001	1995	EVS II Security Plus System For Vehicles with Power Locks and Keyless Entry Includes: siren, starter interrupt and shock sensor	82204268	D.I.Y.	7	155.00
Cherokee, Grand Cherokee	2001	1997	EVS II Security Plus System For Vehicles with Power Locks and Keyless Entry Includes: siren, starter interrupt and shock sensor	82204268	D.I.Y.	7	155.00
Concorde, Intrepid, LHS, 300M	2001	1998	BIG SHOOTER EVS II Security Plus System For Vehicles with Keyless Entry Kits include the wiring harness and headlight illumination. You must order at least 50	82205821	2.5		200.00
Durango, Ram Pickup	2001	1997	EVS II Security Plus System For Vehicles with Power Locks and Keyless Entry Includes: siren, starter interrupt and shock sensor	82204268	D.I.Y.	7	155.00
Minivan (All)	2001	1996	EVS II Security Plus System For Vehicles with Power Locks and Keyless Entry Includes: siren, starter interrupt and shock sensor	82204268	D.I.Y.	7	155.00
Ram Van/Wagon, Dakota (All)	2001	1995	EVS II Security Plus System For Vehicles with Power Locks and Keyless Entry Includes: siren, starter interrupt and shock sensor	82204268	D.I.Y.	7	155.00
WIRING PACKAGES FOR EVS II SECURITY PLUS SYSTEM*							
Breeze, Cirrus, Stratus, Sebring Convertible	2000	1995	Wiring Package for EVS II Security Plus System Use w/PN 82204268 for vehicles w/factory KeyLess Entry	82204210 ¹	2.5		59.00
Cherokee	2001	2000	Wiring Package for EVS II Security Plus System Use w/PN 82204268 for vehicles w/factory KeyLess Entry	82205886 ¹	2.5		59.00
Concorde, Intrepid, LHS, 300M	2001	1998	Wiring Package for EVS II Security Plus System Use w/PN 82204268 for vehicles w/factory KeyLess Entry	82203768	2.5		59.00
Dakota (All)	2001	2001	Wiring Package for EVS II Security Plus System Use w/PN 82204268 for vehicles w/factory KeyLess Entry	82206776 ¹	2.5		59.00
	2000	2000	Wiring Package for EVS II Security plus System Use w/PN 82204268 for vehicles w/factory KeyLess Entry	82205834 ¹	2.5		59.00
Durango	2001	2001	Wiring Package for EVS II Security Plus System Use w/PN 82204268 for vehicles w/factory KeyLess Entry	82206777 ¹	2.5		59.00
	2000	1998	Wiring Package for EVS II Security Plus System Use w/PN 82204268 for vehicles w/factory KeyLess Entry	82204686 ¹	2.5		TBD
Grand Cherokee	2001	1999	Wiring Package for EVS II Security Plus System Use w/PN 82204268 for vehicles w/factory KeyLess Entry	82204685 ¹	2.5		59.00
Minivan (All)	2001	2001	Wiring Package for EVS II Plus Security System Use w/PN 82204268 for vehicles w/power locks and keyless entry	82206639 ¹	2.5		32.00
	2000	1996	Wiring Package for EVS II Plus Security System Use w/PN 82204268 for vehicles w/power locks and keyless entry	82204211 ¹	2.5		55.00
Ram Pickup (All)	2001	1999	Wiring Package for EVS II Security Plus System Use w/PN 82204268 for vehicles w/factory KeyLess Entry	82204682 ¹	2.5		59.00
Ram Van/Wagon	2001	2001	Wiring Package for EVS II Plus Security System Use w/PN 82204268 for vehicles w/power locks	82206775 ¹	2.5		TBD
	2000	1998	Wiring Package for EVS II Plus Security System Use w/PN 82204268 for vehicles w/keyless entry	82204212 ¹	2.5		59.00
Sebring Sedan & Conv., Stratus Sedan	2001	2001	Wiring Package for EVS II Plus Security System Use w/PN 82204268 for vehicles w/keyless entry	82206773 ¹	2.5		64.00

*EVS II is a registered trademark of DaimlerChrysler.

¹ If vehicle is under warranty and a replacement module is needed, call 1-800-34 Mopar for warranty replacement. Have EMCR and vehicle information ready. If customer pay, order 5011649AA for EVS II Plus Module siren and 4883257 for Keyless Entry System Module.

EVS® SYSTEMS, EVS II® SERVICE PARTS

Vehicle Line	MYO	MYI	Application Remarks	Part Number	Instl Time	Group	Sugg Retail Price
EVS II SERVICE PARTS*							
Cherokee, Grand Cherokee, Wrangler	2001	1988	Pin switch, use with PNs 82300985, 05252009 and 82203763	82204234	D.I.Y.		8.50
	2001	1994	Dealer tool for extracting terminals from connectors	82301011	D.I.Y.		33.75
Durango, Ram Pickup	2001	1988	Pin switch, use with PNs 82300985, 05252009 and 82203763	82204234	D.I.Y.		8.50
	2001	1994	Dealer tool for extracting terminals from connectors	82301011	D.I.Y.		33.75
Minivan (All)	2001	1988	Pin switch, use with PNs 82300985, 05252009 and 82203763	82204234	D.I.Y.		8.50
	2001	1994	Dealer tool for extracting terminals from connectors	82301011	D.I.Y.		33.75
Passenger Cars (All)	2001	1988	Pin switch, use with PNs 82300985, 05252009 and 82203763	82204234	D.I.Y.		8.50
	2001	1994	Dealer tool for extracting terminals from connectors	82301011	D.I.Y.		33.75
Ram Van/Wagon, Dakota (All)	2001	1988	Pin switch, use with PNs 82300985, 05252009 and 82203763	82204234	D.I.Y.		8.50
	2001	1994	Dealer tool for extracting terminals from connectors	82301011	D.I.Y.		33.75

*EVS II is a registered trademark of DaimlerChrysler.

† If vehicle is under warranty and a replacement module or siren is needed, call 1-800-34 Mopar for warranty replacement. Have EMCR and vehicle information ready. If customer pay, order 5012164AA for EVS Base Modules, order 4883255 for EVS II System Module, order 4883257 for Keyless Entry System Module, order 5011649AA for EVS II Plus.

EVS® SYSTEMS, KEYLESS ENTRY



Keyless Entry System

REMOTE KEYLESS ENTRY For Vehicles with Power Locks

A welcome alternative to fumbling with keys! Add this system to your vehicle equipped with power locks and enjoy the following benefits:

FEATURES:

- Remote control door/liftgate lock/unlock
- Two remote transmitters
- Illuminated entry
- Programmable lock/unlock with ignition
- Keyless entry is a complete remote radio frequency controlled system designed and engineered for the Ram

OPTIONAL FEATURES INCLUDE:

- 30-second headlamp illumination with flashing parking lamps
- Warning siren for remote control panic alarm (82203198 Siren)
- Complete technical support offered at (800) 34-MOPAR

Vehicle Line	MYO	MYI	Application Remarks	Part Number	Instl Time	Group	Sugg Retail Price
KEYLESS ENTRY SYSTEMS*							
Minivan (All)	2001	1996	For vehicles w/power locks, includes 2 remote transmitters, for optional panic feature order PN 82203198 Siren, Wiring harness PN 82206638 required for installation, sold separately	82300986	1.5	7	178.00
Ram Pickup (All)	2001	1994	For vehicles w/power locks, includes 2 remote transmitters, for optional panic feature order PN 82203198 Siren, Wiring harness PN 82204681 required for installation, sold separately	82300986	1.5	7	178.00
Sebring Sedan & Conv., Stratus Sedan, Concorde, Intrepid, LHS, 300M	2001	2001	For vehicles w/power locks, complete kit, no harness needed, includes 2 remote OE transmitter, requires DRBII to program transmitters	82206643	0.2	7	140.00

*Wiring Packages required, see wiring packages section.

FLOOR MATS, CARPET (OE STYLE)

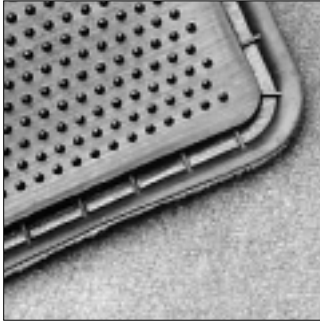

Rubber nibs and molded raised edge



Cherokee



Viper



Intrepid/Concorde/
LHS/300M



Wrangler

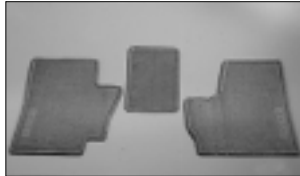

Floor Mats with optional front
center mat (Ram Pickup)

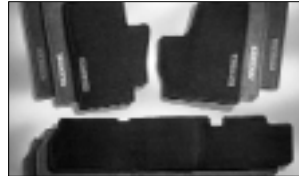

Carpet Floor Mats for Club Cab®
(Ram Pickup)

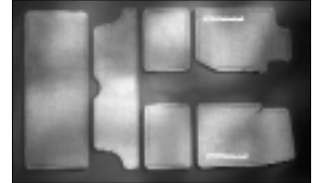

Carpet Floor Mats (Durango)

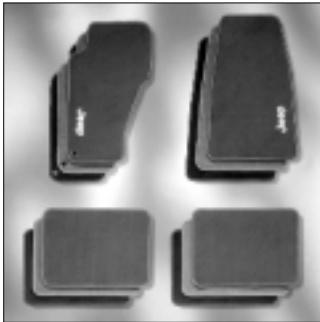

Grand Cherokee

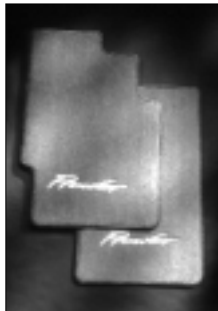

Prowler



Neon



Minivan

MOPAR FEATURES

- Raised edge helps contain snow, water and mud
- 12-ounce or more nylon carpeting with raised edge
- Color matched to interior; custom fit; same as OE
- Nibbed backing helps keep mats in place
- Embroidered logo
- Mopar Accessories are covered by either the 3-year/36,000-mile New Vehicle Limited Warranty, or the 12-month/12,000-mile Mopar Basic Limited Warranty, whichever is more favorable to the customer

COMPETITORS?*

- Is it a plain design?
- Is it polypropylene, which is less durable than nylon?
- Is it a universal size and color?
- Does it have a plain backing, which may cause slippage?
- Viper and Prowler logos are exclusive to DaimlerChrysler Corporation, Dodge, Chrysler, Plymouth and Mopar
- Does the warranty compare?

*Check your market for your competitive situation.

INSTALLATION:

- Easily installed
- Available in pairs for front and rear

FLOOR MATS, CARPET (OE STYLE) (CONT.)

Vehicle Line	MYO	MYI	Application Remarks	Part Number	Instl Time	Group	Sugg Retail Price
FLOOR MATS — CARPET (O.E. STYLE)							
Avenger, Sebring Coupe	2000	1997	Rear - Tan	82203490	D.I.Y.	T	25.00
	2000	1995	Rear - Brown	82300732	D.I.Y.	T	26.00
	2000	1995	Rear - Gray	82300728	D.I.Y.	T	26.00
	2000	1995	Front - Brown	82300731	D.I.Y.	T	38.00
	2000	1995	Front - Gray	82300727	D.I.Y.	T	38.00
	2000	1997	Front - Tan	82203489	D.I.Y.	T	38.00
Breeze, Cirrus, Stratus	2000	1998	Rear - Agate	82203853	D.I.Y.	T	19.25
	2000	1995	Rear - Silver Fern	82203855	D.I.Y.	T	19.25
	2000	1998	Rear - Dark Tan	82204284	D.I.Y.	T	21.00
	2000	1998	Front - Dark Tan	82205357	D.I.Y.	T	38.00
Breeze, Cirrus, Stratus, Sebring Convertible JXi	2000	1995	Front - Silver Fern	82205345	D.I.Y.	T	35.00
	2000	1998	Front - Agate	82205351	D.I.Y.	T	38.00
Cherokee	2001	1999	Rear - Agate	82204680	D.I.Y.	T	26.00
	2001	1998	Rear - Camel	82204679	D.I.Y.	T	26.00
	2001	1999	Front - Agate, Jeep logo w/grommet on driver's side	82204759	D.I.Y.	T	49.00
	2001	1999	Front - Camel, Jeep logo w/grommet on driver's side	82204760	D.I.Y.	T	49.00
Concorde, Intrepid, LHS, 300M	2000	1999	Rear - Agate	82205014	D.I.Y.	T	18.00
	2000	1999	Rear - Dark Quartz	82205016	D.I.Y.	T	18.00
	2000	1999	Rear - Dark Tan	82205017	D.I.Y.	T	18.00
	2001	2001	Rear - Dark Slate	82206496	D.I.Y.	T	20.00
	2001	2001	Rear - Sandstone	82206498	D.I.Y.	T	20.00
	2001	2001	Rear - Taupe	82206494	D.I.Y.	T	20.00
	2000	1999	Front - Agate	82205011	D.I.Y.	T	35.00
	2000	1999	Front - Dark Quartz	82205013	D.I.Y.	T	35.00
	2000	1999	Front - Dark Tan	82205012	D.I.Y.	T	35.00
	2001	2001	Front - Taupe	82206493	D.I.Y.	T	37.00
	2001	2001	Front - Dark Slate	82206495	D.I.Y.	T	37.00
	2001	2001	Front - Sandstone	82206497	D.I.Y.	T	37.00
Dakota (All)	2001	2001	Rear cargo area - Dark Slate w/Rams head	82206515	D.I.Y.	T	47.00
	2001	2001	Rear cargo area - Taupe w/Rams head	82206516	D.I.Y.	T	47.00
	2000	2000	Rear - Agate	82205779	D.I.Y.	T	53.00
	2000	2000	Rear - Mist Gray	82205780	D.I.Y.	T	53.00
	2001	2001	Rear - Dark Slate	82206517	D.I.Y.	T	22.00
	2001	2001	Rear - Taupe	82206518	D.I.Y.	T	22.00
	2000	2000	Rear - Agate, 2 pieces	82205182	D.I.Y.	T	40.00
	2000	2000	Rear - Mist Gray, 2 pieces	82205183	D.I.Y.	T	40.00
	2001	2001	Front - Dark Slate, w/Dodge logo	82206513	D.I.Y.	T	40.00
	2001	2001	Front - Taupe, w/Dodge logo	82206514	D.I.Y.	T	40.00
	2001	2001	Front - Dark Slate w/Dodge logo	82206511	D.I.Y.	T	43.00
	2001	2001	Front - Taupe, w/Dodge logo	82206512	D.I.Y.	T	43.00

FLOOR MATS, CARPET (OE STYLE) (CONT.)

Vehicle Line	MYO	MYI	Application Remarks	Part Number	Instl Time	Group	Sugg Retail Price
FLOOR MATS — CARPET (O.E. STYLE) (CONT.)							
Durango	2001	2001	Rear - Dark Slate, 2nd Seat	82206564	D.I.Y.	T	20.00
	2001	2001	Front - Sandstone, 2nd Seat	82206565	D.I.Y.	T	20.00
	2001	2001	Front - Taupe, 2nd Seat	82206566	D.I.Y.	T	20.00
	2001	2001	Front - Dark Slate, w/Durango logo	82206561	D.I.Y.	T	47.00
	2001	2001	Front - Sandstone, w/Durango logo	82206562	D.I.Y.	T	47.00
	2001	2001	Front - Taupe, w/Durango logo	82206563	D.I.Y.	T	47.00
	2001	2001	Rear - Dark Slate, 3rd seat and cargo area, OE-style w/o logo	82206567	D.I.Y.	T	49.00
	2001	2001	Rear - Sandstone, 3rd seat and cargo area, OE-style w/o logo	82206568	D.I.Y.	T	49.00
	2001	2001	Rear - Taupe, 3rd seat and cargo area, OE-style w/o logo	82206569	D.I.Y.	T	49.00
	2000	2000	Rear - Agate, 2 pieces	82205373	D.I.Y.	T	24.00
	2000	2000	Rear - Camel, 2 pieces	82205372	D.I.Y.	T	24.00
	2000	2000	Rear - Mist Gray, 2 pieces	82205374	D.I.Y.	T	24.00
	2000	2000	Front - Agate, w/Ram's Head logo	82205180	D.I.Y.	T	43.00
	2000	2000	Front - Camel, w/Ram's Head logo	82205371	D.I.Y.	T	43.00
	2000	2000	Front - Mist Gray w/Ram's Head Logo	82205181	D.I.Y.	T	43.00
	2000	2000	Rear - Agate, 3rd Seat Mat	82205778	D.I.Y.	T	48.00
	2000	2000	Rear - Camel, 3rd Seat Mat	82205777	D.I.Y.	T	48.00
	2000	2000	Rear - Mist Gray, 3rd Seat Mat	82205776	D.I.Y.	T	48.00
	Grand Cherokee	2001	2001	Rear - Sandstone w/Jeep logo	82206492	D.I.Y.	T
2001		1999	Rear - Agate w/Jeep logo	82204412	D.I.Y.	T	24.00
2001		1999	Rear - Dark Taupe w/Jeep logo	82204414	D.I.Y.	T	24.00
2000		1999	Rear - Dark Tan w/Jeep logo	82204413	D.I.Y.	T	23.25
2001		2001	Front - Sandstone w/Jeep logo	82206491	D.I.Y.	T	48.00
2001		1999	Front - Agate w/Jeep logo	82204409	D.I.Y.	T	48.00
2001		1999	Front - Dark Taupe w/Jeep logo	82204410	D.I.Y.	T	48.00
2000		1999	Front - Dark Tan w/Jeep logo	82204411	D.I.Y.	T	45.00
Minivan	2001	2001	Front - Taupe	82206303	D.I.Y.	T	37.00
	2001	2001	Front - Navy Blue	82206304	D.I.Y.	T	37.00
	2001	2001	Front - Sandstone	82206305	D.I.Y.	T	37.00
	2001	2001	Middle - Taupe	82206307	D.I.Y.	T	21.00
	2001	2001	Middle - Navy Blue	82206308	D.I.Y.	T	21.00
	2001	2001	Middle - Sandstone	82206309	D.I.Y.	T	21.00
	2001	2001	Rear - Taupe	82206310	D.I.Y.	T	21.00
	2001	2001	Rear - Navy Blue	82206311	D.I.Y.	T	21.00
	2001	2001	Rear - Sandstone	82206312	D.I.Y.	T	21.00
Town & Country Limited	2001	2001	Front - Navy Blue w/Limited logo	82206314	D.I.Y.	T	45.00
	2001	2001	Front - Taupe w/Limited logo	82206302	D.I.Y.	T	45.00
	2001	2001	Middle - Navy Blue	82206315	D.I.Y.	T	32.00
	2001	2001	Middle - Taupe	82206306	D.I.Y.	T	32.00
	2001	2001	Rear - Navy Blue	82206316	D.I.Y.	T	23.00
	2001	2001	Rear - Taupe	82206313	D.I.Y.	T	23.00

FLOOR MATS, CARPET (OE STYLE) (CONT.)

Vehicle Line	MYO	MYI	Application Remarks	Part Number	Instl Time	Group	Sugg Retail Price	
FLOOR MATS — CARPET (O.E. STYLE) (CONT.)								
Minivan (All)	2000	1998	Front - Dark Tan, 1 piece w/Caravan logo	82203954	D.I.Y.	T	44.00	
	2000	1998	Front - Silver Fern, 1 piece w/Caravan logo	82203953	D.I.Y.	T	44.00	
	2000	1998	Front - Mist Gray, 1 piece w/Caravan logo	82203948	D.I.Y.	T	48.00	
	2000	1998	Front or Rear - Dark Tan, intermediate, between front or rear bucket seats	82203965	D.I.Y.	T	10.15	
	2000	1998	Front or Rear - Mist Gray, intermediate, between front or rear bucket seats	82203963	D.I.Y.	T	10.15	
	2000	1998	Front or Rear - Silver Fern, intermediate, between front or rear bucket seats	82203964	D.I.Y.	T	10.15	
	2000	1998	Rear - Dark Tan, (for Quad Seat 3rd Row)	82203919	D.I.Y.	T	19.50	
	2000	1998	Rear - Mist Gray, (for Quad Seat 3rd Row)	82203947	D.I.Y.	T	19.50	
	2000	1998	Rear - Silver Fern, (for Quad Seat 3rd Row)	82203914	D.I.Y.	T	19.50	
	2000	1998	Rear - Taupe, (for Quad Seat 3rd Row)	82204551	D.I.Y.	T	31.00	
	2000	1998	Rear - Dark Tan, intermediate, single runner, quad seat	82203918	D.I.Y.	T	21.50	
	2000	1998	Rear - Mist Gray, intermediate, single runner, quad seat	82203946	D.I.Y.	T	21.50	
	2000	1998	Rear - Silver Fern, intermediate, single runner, quad seat	82203912	D.I.Y.	T	21.50	
	2000	1998	Front - Silver Fern, 2 pieces	82203909	D.I.Y.	T	32.00	
	2000	1998	Front - Mist Gray, 2 pieces	82203943	D.I.Y.	T	35.00	
	2000	1998	Front - Dark Tan, 1 piece w/Pentastar logo	82203956	D.I.Y.	T	44.00	
	2000	1998	Front - Silver Fern, 1 piece w/Pentastar logo	82203951	D.I.Y.	T	44.00	
	2000	1998	Front - Mist Gray, 1 piece w/Pentastar logo	82203950	D.I.Y.	T	48.00	
	2000	1998	Front - Taupe, front, 2 pieces w/Limited logo	82204545	D.I.Y.	T	56.00	
	2000	1998	Rear - Dark Tan, rear, 7-passenger bench, 3-door, includes intermediate mat	82204394	D.I.Y.	T	58.50	
	2000	1998	Rear - Dark Tan, 7-passenger bench, 4-door, includes intermediate mat	82203960	D.I.Y.	T	58.50	
	2000	1998	Rear - Mist Gray, rear, 7-passenger bench, 3-door, includes intermediate mat	82204391	D.I.Y.	T	58.50	
	2000	1998	Rear - Mist Gray, 7-passenger bench, 4-door, includes intermediate mat	82203962	D.I.Y.	T	58.50	
	2000	1998	Rear - Silver Fern, 7-passenger bench, 3-door, includes intermediate mat	82204393	D.I.Y.	T	58.50	
	2000	1998	Rear - Silver Fern, 7-passenger bench, 4-door, includes intermediate mat	82203961	D.I.Y.	T	58.50	
	Neon	2000	2000	Rear - Agate	82204957	D.I.Y.	T	21.00
		2001	2001	Rear - Dark Slate	82206441	D.I.Y.	T	21.00
		2001	2000	Rear - Taupe	82204956	D.I.Y.	T	21.00
2000		2000	Front - Agate	82204955	D.I.Y.	T	38.00	
2001		2001	Front - Dark Slate	82206439	D.I.Y.	T	38.00	
2001		2000	Front - Taupe	82204954	D.I.Y.	T	38.00	
Prowler	2000	1998	Agate, w/yellow Prowler logo	82205126	D.I.Y.	T	69.00	
	2001	1998	Agate, w/silver Prowler logo	82203378	D.I.Y.	T	72.00	

FLOOR MATS, CARPET (OE STYLE) (CONT.)

Vehicle Line	MYO	MYI	Application Remarks	Part Number	Instl Time	Group	Sugg Retail Price
FLOOR MATS — CARPET (O.E. STYLE) (CONT.)							
PT Cruiser	2001	2001	Rear - Dark Taupe	82205476	D.I.Y.	T	19.25
	2001	2001	Front - Dark Taupe	82205474	D.I.Y.	T	35.00
	2001	2001	Front - Dark Taupe (Limited)	82205475	D.I.Y.	T	35.00
Ram Pickup (All)	2001	1998	Rear - Agate, Club Cab and Quad Cab	82204430	D.I.Y.	T	40.00
	2001	1998	Rear - Camel, Club Cab and Quad Cab	82204432	D.I.Y.	T	40.00
	2001	1998	Rear - Mist Gray, Club Cab and Quad Cab	82204431	D.I.Y.	T	40.00
	2001	1998	Front - Agate, w/Dodge logo	82203771	D.I.Y.	T	43.00
	2001	1998	Front - Camel, w/Dodge logo	82203773	D.I.Y.	T	43.00
	2001	1998	Front - Mist Gray, w/Dodge logo	82203772	D.I.Y.	T	43.00
Ram Pickup 4x2	2001	1994	Center - Agate	82203755	D.I.Y.	T	12.00
	2001	1994	Center - Camel	82203756	D.I.Y.	T	12.00
	2001	1998	Center - Mist Gray	82203754	D.I.Y.	T	12.00
Ram Van/Wagon	2000	1998	Front - Camel, 3-piece set	82203457	D.I.Y.	T	51.50
	2000	1998	Front - Mist Gray, 3-piece set	82203663	D.I.Y.	T	51.50
Sebring Convertible	2001	2001	Rear - Dark Taupe	82205962	D.I.Y.	T	21.00
	2001	2001	Rear - Sandstone	82205963	D.I.Y.	T	21.00
	2001	2001	Front - Dark Taupe	82205957	D.I.Y.	T	38.00
	2001	2001	Front - Sandstone	82205958	D.I.Y.	T	38.00
Sebring Convertible JXi	2000	1998	Rear - Agate	82203856	D.I.Y.	T	19.25
	2000	1996	Rear - Silver Fern	82203859	D.I.Y.	T	19.25
	2000	1998	Rear - Tan	82203857	D.I.Y.	T	19.25
Sebring Convertible Limited	2001	2001	Rear - Royal Blue	82206324	D.I.Y.	T	21.00
	2001	2001	Front - Royal Blue	82206325	D.I.Y.	T	38.00
Sebring Coupe, Stratus Coupe	2001	2001	Rear - Black	82206031	D.I.Y.	T	20.00
	2001	2001	Front - Black	82206030	D.I.Y.	T	38.00
Sebring Sedan, Stratus Sedan	2001	2001	Rear - Dark Slate Gray	82205961	D.I.Y.	T	21.00
	2001	2001	Rear - Dark Taupe	82205959	D.I.Y.	T	21.00
	2001	2001	Rear - Sandstone	82205960	D.I.Y.	T	21.00
	2001	2001	Front - Dark Slate Gray	82205956	D.I.Y.	T	38.00
	2001	2001	Front - Dark Taupe	82205954	D.I.Y.	T	38.00
	2001	2001	Front - Sandstone	82205955	D.I.Y.	T	38.00
Viper Coupe	2001	1999	Front - Cognac w/Black-embroidered Viper logo	82205813	D.I.Y.	T	50.00
	2000	1999	Front - Black w/Gray-embroidered Viper logo	82205815	D.I.Y.	T	50.00
Viper RT/10	2001	1999	Front - Cognac, 2 pieces, w/black embroidered Viper logo	82205814	D.I.Y.	T	50.00
Viper RT/10, Viper GTS-L	2001	1992	Front - Black w/Gray Viper Head logo	82206208	D.I.Y.	T	57.00
Wrangler	2001	1999	Front - Agate Jeep logo, w/snaps	82205266	D.I.Y.	T	35.00
	2001	1999	Front - Camel Jeep logo, w/snaps	82205267	D.I.Y.	T	35.00
	2001	1999	Rear - Agate	82204677	D.I.Y.	T	35.00
	2001	1999	Rear - Camel	82204678	D.I.Y.	T	35.00
	2001	1999	Rear - Agate, floor and wheelhouse, 4 pieces	82204669	D.I.Y.	T	153.00
	2001	1999	Rear - Camel, floor and wheelhouse, 4 pieces	82204670	D.I.Y.	T	153.00

FLOOR MATS, FORMED CARPET



Carpet Floor Mats (Grand Cherokee)



Formed Carpet Floor Mats
(shown on Dakota Quad Cab™)

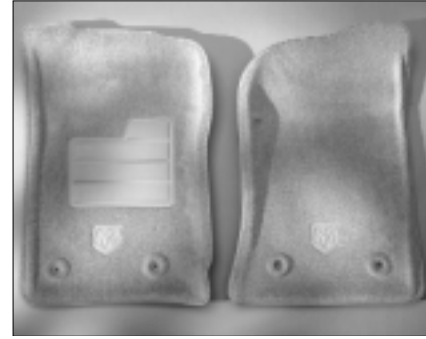

Formed Carpet Floor Mats

MOPAR FEATURES	COMPETITORS?*
<ul style="list-style-type: none"> • 14-oz solution-dyed nylon carpet with Scotchgard® protection • Color matched to interior and custom fit to provide superior coverage • Molded shape with raised edges keeps dirt, snow and mud off vehicle carpet • Nibbed backing helps keep mats in place • Meets DaimlerChrysler Corporation and federal flammability standards • Jeep® or Ram's Head logo • Mopar Accessories are covered by either the 3-year/36,000-mile New Vehicle Limited Warranty, or the 12-month/12,000-mile Mopar Basic Limited Warranty, whichever is more favorable to the customer 	<ul style="list-style-type: none"> • Is it made of polypropylene, which is less durable than nylon? • Is it treated with Scotchgard? • Is it a universal size and color? • Is it a flat mat that allows soil to easily spill onto vehicle floor? • Does it have a plain backing, which may cause slippage? • Does it meet federal (FMVSS 302) flammability standards? • Jeep is exclusive to DaimlerChrysler Corporation, Jeep and Mopar • Does the warranty compare?

*Check your market for your competitive situation.

INSTALLATION:

- Easily installed
- Packaged in pairs for front, one piece for rear

Vehicle Line	MYO	MYI	Application Remarks	Part Number	Instl Time	Group	Sugg Retail Price
FLOOR MATS — FORMED CARPET							
Dakota (All)	2001	2001	Front - Dark Slate	82206754	D.I.Y.	T	97.00
	2001	2001	Front - Taupe	82206755	D.I.Y.	T	97.00
	2000	2000	Front - Agate	82205241	D.I.Y.	T	97.00
	2000	2000	Front - Mist Gray	82205242	D.I.Y.	T	97.00
Durango	2001	2001	Front - Dark Slate	82206754	D.I.Y.	T	97.00
	2001	2001	Front - Taupe	82206755	D.I.Y.	T	97.00
Grand Cherokee	2000	1999	Rear - Dark Tan, 1 piece	82204575	D.I.Y.	T	50.00
	2001	1999	Rear - Agate, 1 piece	82204573	D.I.Y.	T	52.00
	2001	1999	Rear - Taupe, 1 piece	82204574	D.I.Y.	T	52.00
	2001	2001	Rear - Sandstone, 1-piece	82206759	D.I.Y.	T	52.00
	2001	2001	Front - Sandstone, 2 pieces	82206758	D.I.Y.	T	85.00
	2000	1999	Front - Dark Tan, w/Jeep logo	82204572	D.I.Y.	T	85.00
	2001	1999	Front - Agate, w/Jeep logo	82204570	D.I.Y.	T	85.00
2001	1999	Front - Taupe, w/Jeep logo	82204571	D.I.Y.	T	85.00	

FLOOR MATS, RUBBER

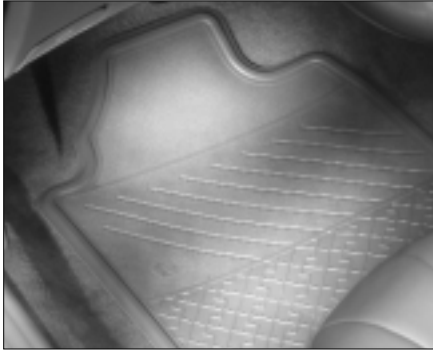

Rubber Floor Mats (shown in Concorde)

MOPAR FEATURES	COMPETITORS?*
<ul style="list-style-type: none"> • Raised edge helps contain snow, water and mud • Color matched to interior and custom fit • Nibbed backing helps keep mats in place • Pentastar logo molded into front mats • Mopar Accessories are covered by either the 3-year/36,000-mile New Vehicle Limited Warranty, or the 12-month/12,000-mile Mopar Basic Limited Warranty, whichever is more favorable to the customer 	<ul style="list-style-type: none"> • Is it a plain design? • Is it a universal size and color? • Does it have a plain backing, which may cause slippage? • Pentastar logo is exclusive to DaimlerChrysler Corporation and Mopar • Does the warranty compare?

*Check your market for your competitive situation.

INSTALLATION:

- Easily installed
- Display hanger packaging in sets of four for front and rear

Vehicle Line	MYO	MYI	Application Remarks	Part Number	Instl Time	Group	Sugg Retail Price
FLOOR MATS — RUBBER							
Breeze, Cirrus, Stratus, Sebring Convertible, Concorde, Intrepid, LHS, 300M	2000	1993	Front and Rear - Agate, Set of four, w/ Pentastar logo	82203491	D.I.Y.	T	31.00
	2000	1995	Front and Rear - Dark Tan, Set of four w/ Pentastar logo	82203695	D.I.Y.	T	31.00
	2000	1994	Front and Rear - Mist Gray, Set of four w/ Pentastar logo	82203696	D.I.Y.	T	31.00
Minivan (All)	2000	1996	Front - Dark Tan, 3 pieces, w/ Pentastar logo	82203905	D.I.Y.	T	38.50
	2000	1996	Front - Mist Gray, 3 pieces, w/ Pentastar logo	82203903	D.I.Y.	T	38.50
	2000	1996	Front - Silver Fern, 3 pieces, w/ Pentastar logo	82203907	D.I.Y.	T	38.50
	2000	1996	Rear - Dark Tan, Quad and Bench	82203906	D.I.Y.	T	54.00
	2000	1996	Rear - Mist Gray, Quad and Bench	82203904	D.I.Y.	T	54.00
	2000	1996	Rear - Silver Fern, Quad and Bench	82203908	D.I.Y.	T	54.00
	2001	2001	Center - Taupe, fits Bench or Quad seats (SWB)	82206686	D.I.Y.	T	36.00
	2001	2001	Center - Navy Blue, fits Bench or Quad seats (SWD)	82206687	D.I.Y.	T	36.00
	2001	2001	Center - Navy Blue, fits Bench or Quad seats (LWB)	82205920	D.I.Y.	T	36.00
	2001	2001	Center - Sandstone, fits Bench or Quad seats (SWB)	82206688	D.I.Y.	T	36.00
	2001	2001	Center - Sandstone, fits Bench or Quad seats (LWB)	82205921	D.I.Y.	T	36.00

FLOOR MATS, RUBBER (CONT.)

Vehicle Line	MYO	MYI	Application Remarks	Part Number	Instl Time	Group	Sugg Retail Price
FLOOR MATS — RUBBER (CONT.)							
Minivan (All)	2001	2001	Center - Taupe, fits Bench or Quad seats (LWB)	82205919	D.I.Y.	T	36.00
	2001	2001	Rear - Navy Blue, fits Bench or Quad seats (LWB)	82205949	D.I.Y.	T	40.00
	2001	2001	Rear - Navy Blue, fits Bench or Quad seats (SWB)	82206690	D.I.Y.	T	40.00
	2001	2001	Rear - Sandstone, fits Bench or Quad seats (LWB)	82205950	D.I.Y.	T	40.00
	2001	2001	Rear - Sandstone, fits Bench or Quad seats (SWB)	82206691	D.I.Y.	T	40.00
	2001	2001	Rear - Taupe, fits Bench or Quad seats (LWB)	82205946	D.I.Y.	T	40.00
	2001	2001	Rear - Taupe, fits bench or Quad seats (SWB)	82206689	D.I.Y.	T	40.00
	2001	2001	Front - Navy Blue	82205917	D.I.Y.	T	40.00
	2001	2001	Front - Sandstone	82205918	D.I.Y.	T	40.00
	2001	2001	Front - Taupe	82205916	D.I.Y.	T	40.00
Sebring Sedan, Stratus Sedan	2001	2001	Rear - Dark Slate Gray	82205976	D.I.Y.	T	45.00
	2001	2001	Rear - Sandstone	82205975	D.I.Y.	T	45.00
	2001	2001	Rear - Dark Taupe	82205974	D.I.Y.	T	45.00
	2001	2001	Front - Sandstone	82205972	D.I.Y.	T	63.00
	2001	2001	Front - Slate Gray	82205973	D.I.Y.	T	63.00
	2001	2001	Front - Dark Taupe	82205971	D.I.Y.	T	63.00
Ram Pickup - Regular Cab (All)	2001	1997	Front - Camel, w/Dodge logo	82202600	D.I.Y.	T	30.00
	2001	1997	Front - Mist Gray, w/Dodge logo	82202599	D.I.Y.	T	30.00

FLOOR MATS, SLUSH-STYLE



Slush-Style Floor Mats



Slush Floor Mats

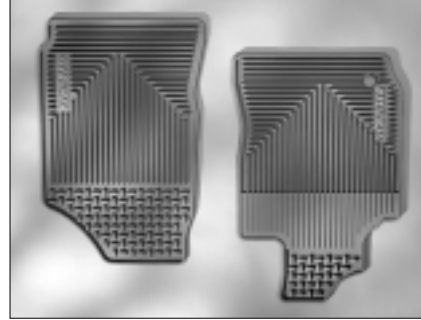

PT Cruiser

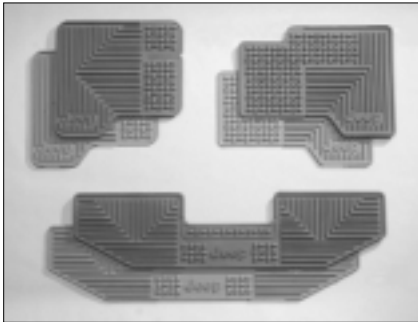

Wrangler

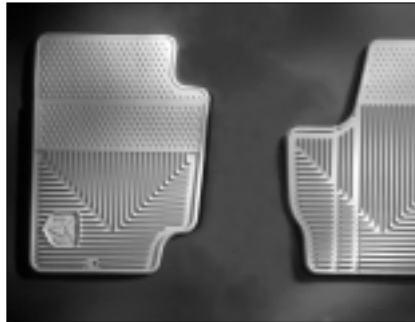

Slush Mats (Ram Pickup)

MOPAR FEATURES

- Custom fit and color matched to vehicle's interior
- Mopar exclusive design
- Heavy-duty, long-lasting construction
- Nibbed backing helps keep mats in place
- Heavyweight construction, rugged, durable
- Deep grooves help contain water, snow and mud to protect floor carpet and your shoes
- Vehicle logo on front mats
- Mopar Accessories are covered by either the 3-year/36,000-mile New Vehicle Limited Warranty, or the 12-month/12,000-mile Mopar Basic Limited Warranty, whichever is more favorable to the customer

COMPETITORS?*

- Do they have a universal color and size?
- Do they have plain backing that may slip and slide?
- Do they have heavyweight construction?
- Vehicle logos are exclusive to DaimlerChrysler Corporation, Jeep and Mopar
- Does the warranty compare?

*Check your market for your competitive situation.

INSTALLATION:

Easily installed

FLOOR MATS, SLUSH-STYLE (CONT.)

Vehicle Line	MYO	MYI	Application Remarks	Part Number	Instl Time	Group	Sugg Retail Price
FLOOR MATS — SLUSH STYLE							
Cherokee	2001	1999	Front - Agate	82204675	D.I.Y.	T	49.00
	2001	1999	Front - Camel	82204676	D.I.Y.	T	49.00
Cherokee, Grand Cherokee	2001	1999	Rear - Agate	82203303	D.I.Y.	T	33.00
	2001	1999	Rear - Dark Tan	82204404	D.I.Y.	T	33.00
Grand Cherokee	2001	1999	Rear - Dark Taupe	82204405	D.I.Y.	T	33.00
	2001	2001	Rear - Sandstone	82206757	D.I.Y.	T	33.00
	2001	1999	Rear - Agate	82203303	D.I.Y.	T	33.00
	2001	1999	Front - Agate	82204400	D.I.Y.	T	47.00
	2000	1999	Front - Camel	82204401	D.I.Y.	T	47.00
	2001	2001	Front - Sandstone	82206756	D.I.Y.	T	47.00
	2001	1999	Front - Taupe	82204402	D.I.Y.	T	47.00
Dakota (All)	2000	1997	Front - Agate	82205084	D.I.Y.	T	47.00
	2000	1997	Front - Mist Gray	82205085	D.I.Y.	T	47.00
	2001	2001	Front - Dark Slate	82206743	D.I.Y.	T	49.00
	2001	2001	Front - Taupe	82206744	D.I.Y.	T	49.00
Dakota Club Cab	2000	1997	Rear - Agate	82203153	D.I.Y.	T	38.50
	2000	1997	Rear - Dark Tan	82203836	D.I.Y.	T	38.50
	2000	1997	Rear - Mist Gray	82203837	D.I.Y.	T	38.50
Dakota Quad Cab	2000	2000	Rear - Agate	82205178	D.I.Y.	T	70.00
	2000	2000	Rear - Mist Gray	82205179	D.I.Y.	T	70.00
	2001	2001	Rear - Taupe	82206753	D.I.Y.	T	70.00
	2001	2001	Rear - Dark Slate	82206752	D.I.Y.	T	70.00
Durango	2000	1998	3rd Seat - Agate	82205363	D.I.Y.	T	38.50
	2000	1998	3rd Seat - Camel	82205364	D.I.Y.	T	38.50
	2000	1998	3rd Seat - Mist Gray	82205365	D.I.Y.	T	38.50
	2001	2001	3rd Seat - Sandstone	82206751	D.I.Y.	T	40.00
	2001	2001	3rd Seat - Dark Slate	82206749	D.I.Y.	T	40.00
	2001	2001	3rd Seat - Taupe	82206750	D.I.Y.	T	40.00
	2000	1998	Front - Agate	82205084	D.I.Y.	T	47.00
	2000	1998	Front - Camel	82205086	D.I.Y.	T	47.00
	2000	1998	Front - Mist Gray	82205085	D.I.Y.	T	47.00
	2001	2001	Front - Sandstone	82206745	D.I.Y.	T	49.00
	2001	2001	Front - Dark Slate	82206743	D.I.Y.	T	49.00
	2001	2001	Front - Taupe	82206744	D.I.Y.	T	49.00
	2000	1998	Rear - Agate	82204365	D.I.Y.	T	51.50
	2000	1998	Rear - Camel	82203613	D.I.Y.	T	51.50
	2000	1998	Rear - Mist Gray	82203612	D.I.Y.	T	51.50
	2001	2001	Front - Dark Slate, 2nd seat	82206746	D.I.Y.	T	53.00
	2001	2001	Rear - Sandstone, 2nd seat	82206748	D.I.Y.	T	53.00
	2001	2001	Rear - Taupe, 2nd seat	82206747	D.I.Y.	T	53.00

FLOOR MATS, SLUSH-STYLE (CONT.)

Vehicle Line	MYO	MYI	Application Remarks	Part Number	Instl Time	Group	Sugg Retail Price
FLOOR MATS — SLUSH STYLE (CONT.)							
Minivan (All)	2000	1996	Rear - Camel, 1 piece, Bench seat only	82204894	D.I.Y.	T	51.50
	2000	1996	Rear - Mist Gray, 1 piece, Bench seat only	82204813	D.I.Y.	T	51.50
	2000	1996	Rear - Silver Fern, 1 piece, Bench seat only	82204893	D.I.Y.	T	51.50
	2000	1996	Rear - Camel, 1 piece, 2nd row	82204812	D.I.Y.	T	66.00
	2000	1996	Rear - Mist Gray, 1 piece, 2nd row	82204803	D.I.Y.	T	66.00
	2000	1996	Rear - Silver Fern, 1 piece, 2nd row	82204811	D.I.Y.	T	66.00
	2000	1996	Rear - Taupe, 1 piece	82204896	D.I.Y.	T	68.00
	2000	1996	Front - Camel	82204890	D.I.Y.	T	80.00
	2000	1996	Front - Mist Gray	82204802	D.I.Y.	T	80.00
	2000	1996	Front - Silver Fern	82204891	D.I.Y.	T	80.00
	2000	1996	Front - Taupe	82204892	D.I.Y.	T	80.00
Neon	2001	2001	Rear - Dark Slate	82206445	D.I.Y.	T	45.00
	2001	2001	Front - Dark Slate w/Neon logo	82206443	D.I.Y.	T	63.00
	2000	2000	Front - Agate	82205170	D.I.Y.	T	45.00
	2001	2000	Rear - Taupe	82205171	D.I.Y.	T	45.00
	2000	2000	Front - Agate	82205169	D.I.Y.	T	63.00
	2001	2000	Front - Taupe	82205168	D.I.Y.	T	63.00
PT Cruiser	2001	2001	Rear - Taupe	82205337	D.I.Y.	T	50.00
	2001	2001	Front - Taupe w/ PT Cruiser logo	82205336	D.I.Y.	T	67.00
Ram Pickup (All)	2001	1998	Front - Agate w/ Rams Head logo	82203712	D.I.Y.	T	83.00
	2001	1998	Front - Camel w/ Rams Head logo	82203714	D.I.Y.	T	83.00
	2001	1998	Front - Mist Gray w/ Rams Head logo	82203715	D.I.Y.	T	83.00
	2001	1994	Center - Camel, automatic 2WD transmission only	82203720	D.I.Y.	T	24.00
	2001	1994	Center - Agate, automatic 2WD transmission only	82203716	D.I.Y.	T	24.00
	2001	1994	Center - Mist Gray, automatic 2WD transmission only	82203713	D.I.Y.	T	24.00
Ram Pickup - Club or Quad Cab	2001	1998	Rear - Agate, 1 piece	82203717	D.I.Y.	T	68.00
	2001	1998	Rear - Camel, 1 piece	82203718	D.I.Y.	T	68.00
	2001	1998	Rear - Mist Gray, 1 piece	82203719	D.I.Y.	T	68.00
Wrangler	2001	1999	Rear - Agate	82204757	D.I.Y.	T	29.00
	2001	1999	Rear - Camel	82204756	D.I.Y.	T	29.00
	2001	1999	Front - Agate w/Jeep logo	82204673	D.I.Y.	T	40.00
	2001	1999	Front - Camel w/Jeep logo	82204674	D.I.Y.	T	40.00

GARMENT BAGS

Vehicle Line	MYO	MYI	Application Remarks	Part Number	Instl Time	Group	Sugg Retail Price
GARMENT BAGS							
Prowler	2001	1998	Fitted luggage Garment Bag, black nylon w/embroidered Prowler logo	82204519	D.I.Y.		112.00
Viper Coupe	2001	1997	Small Kit Bag, nylon, part of Viper set, w/Viper Logo, sized to tuck into cargo well	82204900	D.I.Y.		75.00
	2001	1997	Soft Sided Suitcase, nylon, part of Viper set, w/Viper logo, sized to sit in rear cargo well	82204898	D.I.Y.		190.00
	2001	1997	Soft Sided Suitcase, nylon, w/Viper logo	82204899	D.I.Y.		205.00
	2001	1997	Folding Garment Bag, nylon, part of Viper set, w/Viper logo, sized to lay on rear shelf area	82204897	D.I.Y.		335.00

GAS CAP, LOCKING



Locking Gas Cap

MOPAR FEATURES	COMPETITORS?*
<ul style="list-style-type: none"> • Screw-on design for tight fit • “Free wheeling” when locked, deters breaking open • Constructed of plastic with stainless steel key, lock • Rust-resistant black satin finish • Meets federal fuel system leakage standards • New quarter-turn release for easy operation • Mopar Accessories are covered by either the 3-year/36,000-mile New Vehicle Limited Warranty, or the 12-month/12,000-mile Mopar Basic Limited Warranty, whichever is more favorable to the customer 	<ul style="list-style-type: none"> • Is it a snap-on design? • Is it a fixed-in-place design that can snap off easily? • Is it chrome-plated, which may rust? • Does it meet federal fuel system leakage standards? • Does the warranty compare?

*Check your market for your competitive situation.

INSTALLATION:

- No special tools required
- Two keys included

Vehicle Line	MY0	MY1	Application Remarks	Part Number	Instl Time	Group	Sugg Retail Price
LOCKING GAS CAPS							
300M, Breeze, Concorde, Intrepid, LHS, Neon, PT Cruiser, Sebring Convertible, Sebring Coupe ('01 Only), Sebring Sedan, Stratus (All)	2001	2000	Black, keyed to ignition by dealer (Quick-on type)	05015636AA	0.3	T	34.25
Cherokee, Grand Cherokee	2001	2000	Black, w/2 keys, (Quick-on type)	05278655AA	0.1	T	12.75
Durango, Ram Pickup	2001	2000	Black, w/2 keys, (Quick-on type)	05278655AA	0.1	T	12.75
Grand Cherokee	2000	1999	Black, w/2 keys, (Screw-on type)	82400806	0.1	T	12.75
Minivan (All)	2001	1999	Black, w/2 keys, (Quick-on type)	05278655AA	0.1	T	12.75
Ram Van/Wagon, Dakota (All)	2001	2000	Black, w/2 keys, (Quick-on type)	05278655AA	0.1	T	12.75
Wrangler	2000	1997	Black, w/2 keys, (screw-on-type)	82202338	0.1	T	15.00
	2001	2001	Black, keyed to ignition by dealer (Quick-on type)	05016763AB	0.3	T	40.00

GROCERY BAG HOLDERS



Grocery Bag Holders



Grocery Bag Holders



Grocery Bag Holders (shown in Neon)



Interior Bag Holder (shown in Durango)

MOPAR FEATURES

- Secures handles of plastic shopping bags, avoids spilling of groceries, etc.
- Keeps rear compartment neat
- Easily installed and removed
- Mopar Accessories are covered by either the 3-year/36,000-mile New Vehicle Limited Warranty, or the 12-month/12,000-mile Mopar Basic Limited Warranty, whichever is more favorable to the customer

COMPETITORS?*

- Is competitor's easy to install and remove?
- Does the warranty compare?

*Check your market for your competitive situation.

GROCERY BAG HOLDERS (CONT.)

Vehicle Line	MYO	MYI	Application Remarks	Part Number	Instl Time	Group	Sugg Retail Price
GROCERY BAG HOOKS							
Breeze, Cirrus, Stratus, Sebring Sedan & Conv., Stratus Sedan, Sebring Convertible, Concorde, Intrepid, LHS, 300M, Neon, Sebring Coupe, Stratus Coupe	2001	1993	Hooks under the trunk lid weather strip, set of 4	82205033	D.I.Y.	T	7.00
Durango	2000	1998	Camel, molded hooks (2), includes hardware, equipped w/3rd seat	82204974	0.3	T	28.00
	2000	1998	Mist Gray, molded hooks (2), includes hardware, equipped w/3rd seat	82204975	0.3	T	28.00
	2001	1998	Agate, molded hooks (2), includes hardware, equipped w/3rd seat	82204973	0.3	T	30.00
	2001	2001	Sandstone, molded hooks (2), includes hardware, mount to back of 3rd seat	82206524	0.3	T	30.00
	2001	2001	Taupe, molded hooks (2), includes hardware, mount to back of 3rd seat	82206525	0.3	T	30.00
Grand Cherokee	2000	1999	Dark Tan, molded hooks (2), includes hardware	82204971	0.4	T	28.00
	2001	1999	Agate, molded hooks (2), includes hardware	82204616	0.4	T	30.00
	2001	2001	Sandstone, Holder Kit	82206604	0.4		30.00
	2001	1999	Taupe, molded hooks (2), includes hardware	82204972	0.4	T	30.00

GROUND EFFECTS — AIR DAMS, SIDE SKIRTS AND WHEEL LIP MOLDINGS



Air Dams, Wheel Lip Holding and Side Skirt Kit



Ground Effects Package, rear view

MOPAR FEATURES

- All Mopar products have been designed to meet the Federal Motor Vehicle Safety Standards for side impact
- All Mopar mounting hardware is designed to provide superior corrosion protection
- Only the highest quality finishes are used: powder-coat finishes and durable clear coatings
- Designed for simple installation with minimal drilling, these products are manufactured using the advanced RIM (Reaction Injection Molding) process for a precise fit to your vehicle.
- The polyurethane material includes glass filler, which preserves structural integrity without compromising the material's excellent lightweight, weather-resistant properties
- Stringently tested in seven categories for durability, including paint hardness and salt-spray, humidity and gravel resistance, these accessories will stand up to the toughest conditions year after year
- Mopar Accessories are covered by either the 3-year/36,000-mile New Vehicle Limited Warranty, or the 12-month/12,000-mile Mopar Basic Limited Warranty, whichever is more favorable to the customer

COMPETITORS?*

- Do they meet the FMVSS side-impact tests?
- Do the brackets have enamel finishes that may chip? Would they survive DaimlerChrysler's 250-hour salt spray test?
- Do they use less expensive finishes that are more prone to rust, pitting and scratches?
- Does the warranty compare?

*Check your market for your competitive situation.

Vehicle Line	MY0	MY1	Application Remarks	Part Number	Instl Time	Group	Sugg Retail Price
GROUND EFFECTS PACKAGE — PT CRUISER							
PT Cruiser	2001	2001	Primed — Side Skirt Kit	82205705	0.8		290.00
	2001	2001	Black — Side Skirt Kit	82205738	0.8		440.00
	2001	2001	Inferno Red — Side Skirt Kit	82205737	0.8		440.00
	2001	2001	Bright Silver Metallic — Side Skirt Kit	82205736	0.8		440.00
	2001	2001	Air Dam Kit, front and rear, primed for painting	82205703	0.8		250.00
	2001	2001	Black — Air Dam Kit, front and rear	82205732	0.8		355.00
	2001	2001	Inferno Red — Air Dam Kit, front and rear	82205731	0.8		355.00
	2001	2001	Bright Silver Metallic — Air Dam Kit, front and rear	82205730	0.8		355.00
	2001	2001	Primed — Wheel lip molding kit, set of four	82205704	0.5		310.00
	2001	2001	Black — Wheel lip molding kit, set of four	82205735	0.5		480.00
	2001	2001	Inferno Red — Wheel lip molding kit, set of four	82205734	0.5		480.00
	2001	2001	Bright Silver Metallic — Wheel lip molding kit, set of four	82205733	0.5		480.00
CHROME EXHAUST TIP							
PT Cruiser	2001	2001	Exhaust Tip — Chrome	82205833	0.3		31.50

GUARDS — BRUSH/GRILLE, QUICK REFERENCE



MOLDED GRILLE GUARD



MOLDED BRUSH GUARD



TUBULAR GRILLE GUARD



DELUXE TUBULAR BRUSH GUARDS

MOPAR FEATURES

- All guards are developed and approved by the Dodge Design Team to ensure they match Dodge truck's unique lines
- Mounting with stainless steel hardware is designed specifically for each vehicle, minimizing installation time and maximizing strength and durability
- All Mopar mounting hardware is designed to provide superior corrosion protection
- Mandrel tube-bending technology is used during the fabrication of tubular products to ensure wrinkle-free contours
- All Mopar guards are designed to meet Federal Motor Vehicle Safety Standards for occupant protection
- Design will not adversely affect airflow to the engine compartment or impede hood operation
- Only the highest quality finishes are used: Hexavalent chrome, aluminum anodizing, E-coat primers, powder-coat finishes and durable clear coatings
- Mopar Accessories are covered by either the 3-year/36,000-mile New Vehicle Limited Warranty or the 12-month/12,000-mile Mopar Basic Limited Warranty, whichever is more favorable to the customer

COMPETITORS?*

- Will the guard match the lines of Dodge trucks?
- Is the bracket system an "erector set" (i.e., many holes for many applications)? Is the hardware corrosion-resistant?
- Do the brackets have enamel finishes that may chip? Would they survive DaimlerChrysler's 250-hour salt-spray test?
- Do ripples appear in the tubes where they have been curved?
- Does the guard meet Federal Motor Vehicle Safety Standards? Will its installation affect the standards?
- Will the design restrict airflow to the engine or impede hood operation?
- Do they use less expensive finishes that are more prone to rust, pitting and scratches?
- Does the warranty compare?

*Check your market for your competitive situation.

GUARDS — BRUSH, JEEP®



Brush Guard (shown on Cherokee)



Brush Guard (shown on Wrangler)



Molded Brush Guard
(shown on Grand Cherokee)

MOPAR FEATURES

- Anodized aluminum resists corrosion, pitting, peeling, and is scratch resistant
- TPO plastic end caps resist shrinking, expanding and cracking
- E-coat primer and powder-coat paint provide durable finish
- Available in chrome, silver aluminum or black painted steel crossbars
- Chrome is designed to meet tough 44-hour CASS test
- The chrome finish consists of .001-ductile nickel base coating for strength, covered by .0005-semi-bright nickel seal coat and topped with hexavalent chrome plating that provides a bright, rust-resistant product
- Mopar uses stainless steel fasteners and hardware
- Mandrel tubing bends for a full, round appearance
- Interior welds provide clean appearance
- Designed specifically to match the contours of the front bumper; 2½" oval center tubes, with ¼" upright stanchion plates, attach to frame
- Does not adversely affect airflow to the engine compartment, or impede the opening or closing of the hood
- Designed to meet Federal Motor Vehicle Safety Standards for occupant protection
- Aligns to vehicle frame
- Genuine Jeep design approved by Jeep Design Team
- Mopar Accessories are covered by either the 3-year/36,000-mile New Vehicle Limited Warranty, or the 12-month/12,000-mile Mopar Basic Limited Warranty, whichever is more favorable to the customer

COMPETITORS?*

- Is it anodized aluminum?
- Will it pit or corrode?
- Does it have an E-coat/powder-coat finish, or an enamel finish, which may chip, scratch and rust easily?
- Does chrome meet Mopar's standards for finish and durability?
- Are plain steel fasteners used, which may rust?
- Is all hardware stainless steel?
- Are tubes bent without mandrel, resulting in a flat or unsightly appearance?
- Does it have unsightly exterior weld marks?
- Is it a universal fit?
- Is it a hang-on design?
- Has product been designed to meet government regulations?
- Is drilling required for frame attachment?
- Does the warranty compare?

*Check your market for your competitive situation.

INSTALLATION:

- Brush Guard is preassembled for quicker installation
- Kit includes mounting brackets with stainless steel hardware

GUARDS — BRUSH, JEEP® (CONT.)

Vehicle Line	MYO	MYI	Application Remarks	Part Number	Instl Time	Group	Sugg Retail Price
BRUSH GUARDS — CHEROKEE**†							
Cherokee	2001	1997	Bracketry to re-locate front bumper license plate frame - used on grille/brush guards with lower fascia that covers front license plate	82203525	0.2		34.25
	2001	1997	Black Steel	82203342	1.0	T	500.00
	2001	1997	Silver aluminum	82203340	1.0	T	530.00
	2001	1997	Chrome Steel	82203341	1.0	T	600.00
	2001	1997	Black steel, w/integrated Fog Lights - Vehicles with tow hooks require reinforcement kit pn 82203591	82203419	1.0	T	655.00
	2001	1997	Silver aluminum, w/integrated Fog Lights - Vehicles with tow hooks require reinforcement kit pn 82203591	82203417	1.0	T	680.00
	2001	1997	Chrome steel, w/integrated Fog Lights - Vehicles with tow hooks require reinforcement kit pn 82203591	82203418	1.0	T	775.00
BRUSH GUARDS — WRANGLER***††							
Wrangler	2001	1997	Black steel, not for use w/winch or tow hooks	82202147	0.5	T	355.00
	2001	1997	Black aluminum, not for use w/winch or tow hooks	82202148	0.5	T	390.00
	2001	1997	Silver aluminum, not for use w/winch or tow hooks	82202149	0.5	T	390.00
	2001	1997	Chrome steel, not for use w/winch or tow hooks	82202150	0.5	T	500.00
BRUSH GUARDS, MOLDED — GRAND CHEROKEE*							
Grand Cherokee	2000	1999	Deep Slate (PAW)	82204587	0.6	T	600.00
	2001	1999	Black (PX8)	82204588	0.6	T	615.00
	2001	1999	Champagne (PTH)	82204583	0.6	T	615.00
	2000	1999	Everglade (WPT)	82204584	0.6	T	615.00
	2001	1999	Flame Red (PR4)	82204581	0.6	T	615.00
	2001	1999	Patriot Blue (PB7)	82204585	0.6	T	615.00
	2001	1999	Shale Green (PGR)	82205622	0.6	T	615.00
	2001	1999	Sienna (PUL)	82204580	0.6	T	615.00
	2001	1999	Silverstone (PS5)	82205623	0.6	T	615.00
	2001	2001	Steel Blue (XBQ)	82206502	0.6	T	615.00
	2001	1999	Stone White (PW1)	82204589	0.6	T	615.00
	2000	1999	Taupe Frost (PTK)	82204582	0.6	T	615.00
	2001	2001	Woodland Brown (YUB)	82206501	0.6	T	615.00
	2001	2000	Dark Gray, matches Laredo cladding	82205218	0.6	T	615.00
	2001	1999	Medium Driftwood, matches Laredo cladding	82204579	0.6	T	615.00
BRUSH GUARDS, TUBULAR — GRAND CHEROKEE*							
Grand Cherokee	2001	2000	Dark Gray, matches Laredo cladding	82205223	0.8	T	510.00
	2001	1999	Black steel	82205162	0.8	T	510.00
	2001	1999	Medium Driftwood, matches Laredo cladding	82205161	0.8	T	510.00
	2001	1999	Silver aluminum	82205163	0.8	T	535.00
	2001	1999	Chrome steel	82205164	0.8	T	680.00

*NOTE: These products are designed to enhance the appearance of the vehicle. Since their safety characteristics are limited, they are not intended to prevent injury or damage in the event of an accident.

† Installation Package required to enable Fog Light operation. Vehicles with front tow hooks, Reinforcement Kit PN 82203591 is also required.

‡ Wiring harness required on vehicles with Fog Lights to relocate lights inboard.

§ Cannot be used with Tow Hooks

* If front license plate is required, order PN 52003479 separately.

GUARDS — DELUXE TUBULAR BRUSH GUARD, TRUCK



Deluxe Tubular Brush Guard (shown on Ram)



Guard meets FMVSS for lighting

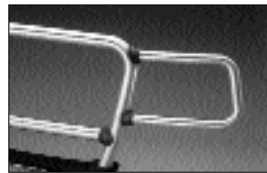

Chrome gasket protects surface at weld joint



License plate mounting

FEATURES:

- 2.0" diameter grille area tubes and 1½" brush guards
- Mandrel-formed for smooth finish
- Tubular design with integrated TPO fascia was designed to match the contours of Dodge Dakota
- Approved by the Dodge Design Team
- Designed to meet Federal Motor Vehicle Safety Standards for occupant protection and vehicle lighting
- Design does not adversely affect airflow to the engine compartment or impede operation of the hood
- Painted guards receive an E-coat primer and powder-coat paint
- OE-quality chrome finish consists of a 1.5-mil base coating for strength (1.15-mil semi-bright; .35-mil bright) and a .01-mil Hexavalent chrome surface plating that provides a bright, rust-resistant finish
- Protective gaskets over welded joints on chrome guards help protect against rust
- Anodized aluminum resists corrosion, pitting, peeling and is scratch resistant
- Not for use with Tow Hooks

SPECIFICATIONS:

- 2.0" main tubes with 1½" brush guard sections
- Mandrel bending construction produces wrinkle-free bends

INSTALLATION:

- Brush/Grille Guard is preassembled for quicker installation
- Kit includes mounting brackets with stainless steel hardware
- Frame bracket mounts securely to existing holes in vehicle's frame
- Stiffener guard bracket mounts directly to bumper
- Existing license plate frame on vehicle must be relocated to lower fascia

NOTE: This product is designed solely to enhance the appearance of the vehicle. Since the safety characteristics are limited, it is not intended to prevent injury or damage in the event of an accident. Check state and local regulations on installation and use.

GUARDS — DELUXE TUBULAR BRUSH GUARD, TRUCK

Vehicle Line	MYO	MYI	Application Remarks	Part Number	Instl Time	Group	Sugg Retail Price
BRUSH GUARDS, TUBULAR — RAM PICKUP							
Ram Pickup (All)	2001	1994	Black steel	82202856	1.0	T	460.00
	2001	1994	Black aluminum	82202858	1.0	T	475.00
	2001	1994	Silver aluminum	82202857	1.0	T	475.00
	2001	1994	Chrome	82202691	1.0	T	590.00
	2001	1999	Black aluminum, Ram Sport	82205212	1.5	T	475.00
	2001	1999	Black steel, Ram Sport	82205213	1.5	T	475.00
	2001	1999	Silver aluminum, Ram Sport	82205211	1.5	T	475.00
	2001	1999	Chrome, Ram Sport	82205210	1.5	T	590.00
BRUSH GUARDS, DELUXE TUBULAR — DAKOTA/DURANGO*							
Dakota, Durango	2001	1997	Black steel w/o lower fascia	82206479	1.0	T	450.00
	2000	2000	Dark Garnet Red (PRV)	82205952	1.0	T	505.00
	2000	2000	Amber Fire (PV3)	82205951	1.0	T	505.00
	2001	2001	Amber Fire (XV3)	82206476	1.0	T	505.00
	2000	2000	Aquamarine (PQW)	82205762	1.0	T	505.00
	2000	1997	Black (PX8)	82203922	1.0	T	505.00
	2001	2001	Black steel (DX8)	82206469	1.0	T	505.00
	2000	1997	Bright platinum (PS4)	82205143	1.0	T	505.00
	2001	2001	Bright Silver (WSB)	82206474	1.0	T	505.00
	2000	1997	Bright White (PW7)	82203924	1.0	T	505.00
	2001	2001	Bright White (PW7)	82206470	1.0	T	505.00
	2000	1997	Chili Pepper Red (PEA)	82203923	1.0	T	505.00
	2001	2001	Dark Garnet Red (QRV)	82206477	1.0	T	505.00
	2000	1997	Deep Amethyst (PCN)	82203804	1.0	T	505.00
	2000	1997	Flame Red (PR4)	82203925	1.0	T	505.00
	2001	2001	Flame Red (PR4)	82206471	1.0	T	505.00
	2000	1997	Forest Green (PG8)	82203926	1.0	T	505.00
	2001	2001	Forest Green (PG8)	82206472	1.0	T	505.00
	2000	1997	Intense Blue (PB3)	82203805	1.0	T	505.00
	2001	2001	Intense Blue (VB3)	82206481	1.0	T	505.00
	2000	1997	Light Driftwood (PFK)	82203803	1.0	T	505.00
	2001	2001	Medium Bronze (XTL)	82206475	1.0	T	505.00
	2000	1997	Patriot Blue (PB7)	82205142	1.0	T	505.00
	2001	2001	Patriot Blue (WBT)	82206473	1.0	T	505.00
	2000	2000	Sierra Bronze (PTL)	82205763	1.0	T	505.00
	2001	2001	Silver aluminum finish	82206468	1.0	T	505.00
	2000	1997	Silver aluminum	82204017	1.0	T	510.00
	2001	1997	Chrome w/o lower fascia	82206480	1.0	T	535.00
	2000	1997	Chrome	82203807	1.0	T	655.00

*NOTE: These products are designed to enhance the appearance of the vehicle. Since their safety characteristics are limited, they are not intended to prevent injury or damage in the event of an accident.

† Installation Package required to enable Fog Light operation. Vehicles with front tow hooks, Reinforcement Kit PN 82203591 is also required.

GUARDS — BRUSH, MOLDED, RAM SPORT PICKUP



Molded Brush Guard (Shown on Ram Sport Pickup)



Unique one-piece design



Designed to meet FMVSS for lighting visibility

FEATURES:

- Unique one-piece design
- Designed using advanced computer software that allows engineers to match the unique front end of the new Ram Sport Pickup exactly
- Nitrogen-injected ABS construction results in a Grille Guard that is lighter and more impact-resistant than conventional guards
- Designed to meet FMVSS for occupant protection and lighting
- Available in select body colors
- Cleans easily with soap and water

INSTALLATION:

Easy to install

NOTE: This product is designed solely to enhance the appearance of the vehicle. Since the safety characteristics are limited, it is not intended to prevent injury or damage in the event of an accident. Check state and local regulations on installation and use.

Vehicle Line	MYO	MYI	Application Remarks	Part Number	Instl Time	Group	Sugg Retail Price
MOLDED BRUSH GUARDS — RAM SPORT PICKUP*							
Ram Sport Pickup	2001	1999	Black (PX8)	82204930	1.2	T	545.00
	2001	1999	Bright White (PW7)	82204492	1.2	T	545.00
	2001	1999	Flame Red (PR4)	82204928	1.2	T	545.00
	2001	1999	Forest Green (PG8)	82204926	1.2	T	545.00
	2001	1999	Intense Blue (PB3)	82204927	1.2	T	545.00
	2001	2001	Amber Fire (XVL)	82206499	0.8	T	545.00
	2000	1999	Solar Yellow (PYH)	82204929	1.2	T	530.00

*NOTE: These products are designed to enhance the appearance of the vehicle. Since their safety characteristics are limited, they are not intended to prevent injury or damage in the event of an accident.

GUARDS — GRILLE, JEEP®



Tubular Grille Guard
(shown on Grand Cherokee)

MOPAR FEATURES	COMPETITORS?*
<ul style="list-style-type: none"> • Polyurethane resists corrosion, pitting, peeling and is scratch resistant • Mopar uses stainless steel fasteners and hardware • Polyurethane foam is molded in 80 percent color • Genuine Jeep design approved by Jeep Design Team • The design ensures that the product will not adversely affect airflow to the engine compartment • Does not impede the opening and closing of the hood • Designed specifically to match the contours of the front bumper • Designed to meet Federal Motor Vehicle Safety Standards requirements for lighting and occupant protection • Jeep logo • Mopar Accessories are covered by either the 3-year/36,000-mile New Vehicle Limited Warranty, or the 12-month/12,000-mile Mopar Basic Limited Warranty, whichever is more favorable to the customer 	<ul style="list-style-type: none"> • Is it steel? • Will it pit or corrode? • Are plain steel fasteners used, which may rust? • Is all hardware stainless steel? • Is it black or yellow underneath? • Will the sub-color show through? • Genuine Jeep vehicle-designed products are exclusive to Mopar • Is it a universal fit? • Is it a hang-on design? • Does it meet government safety regulations? • Jeep is exclusive to DaimlerChrysler Corporation, Jeep and Mopar • Does the warranty compare?

*Check your market for your competitive situation.

INSTALLATION:

Installs easily

Vehicle Line	MYO MYI	Application Remarks	Part Number	Instl Time	Group	Sugg Retail Price
GRILLE GUARDS — GRAND CHEROKEE*						
Grand Cherokee	2001 1999	Black steel	82204592	0.8	T	290.00
	2001 2000	Dark Gray, matches Laredo cladding	82205222	0.8	T	290.00
	2001 1999	Medium Driftwood, matches Laredo cladding	82204594	0.8	T	290.00
	2001 1999	Silver aluminum	82204591	0.8	T	300.00
	2001 1999	Chrome steel	82204590	0.8	T	450.00

*NOTE: These products are designed to enhance the appearance of the vehicle. Since their safety characteristics are limited, they are not intended to prevent injury or damage in the event of an accident.

GUARDS — GRILLE, TRUCK



Tubular Chrome Grille Guard (shown on Dakota)

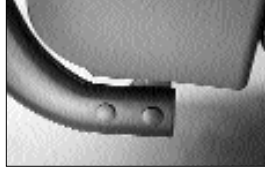

Mounts directly to frame



Contour design with chrome crossbars and black end caps



Tubular Brush Guard (shown on Ram Pickup)



Tubular Grille Guard (shown on Ram Pickup)



Custom design end caps (Grille Guard)

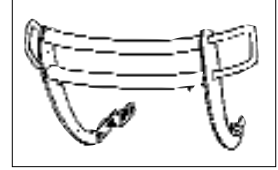

Tubular Brush Guard (preassembled to reduce installation time)

FEATURES:

- 2½" oval center tubes, with ¼" upright stanchion plates, attach to frame
- Available in chrome, Silver or Black aluminum, or Black painted steel
- Anodized aluminum resists corrosion, pitting, peeling and is scratch-resistant
- Chrome designed to meet tough 44-hour Copper Accelerated Salt Spray (CASS) test
- OE-quality chrome finish consists of a .5-mil base coating for strength (1.15-mil semi-bright; .35-mil bright) and a .01-mil Hexavalent chrome surface plating that provides a bright, rust-resistant finish
- E-coat primer and powder-coat paint provide a durable finish
- Crossbars follow the contours of the grille
- TPO plastic end caps resist shrinking, expanding and cracking
- Does not restrict airflow to engine compartment or impede operation of hood
- Cleans easily with soap and water
- Grille Guard is designed to meet FMVSS for occupant protection and vehicle lighting
- Provides hood opening clearance
- Mandrel tube bending provides a neat, clean, finished appearance without "wrinkles"

INSTALLATION:

- Grille Guard is preassembled for quicker installation
- Kit includes mounting brackets with stainless steel and cadmium hardware

Vehicle Line	MYO	MYI	Application Remarks	Part Number	Instl Time	Group	Sugg Retail Price
GRILLE GUARDS — RAM PICKUP*							
Ram Pickup (All)	2001	1994	Black steel - except sport	82202853	1.0	T	275.00
	2001	1994	Black aluminum - except sport	82202855	1.0	T	335.00
	2001	1994	Silver aluminum - except sport	82202854	1.0	T	335.00
	2001	1994	Chrome - except sport	82202692	1.0	T	420.00

*NOTE: These products are designed to enhance the appearance of the vehicle. Since their safety characteristics are limited, they are not intended to prevent injury or damage in the event of an accident.

GUARDS — GRILLE, TRUCK (CONT.)

Vehicle Line	MYO	MYI	Application Remarks	Part Number	Instl Time	Group	Sugg Retail Price
GRILLE GUARDS TUBULAR — DAKOTA/DURANGO*†							
Dakota, Durango	2000	1997	Black steel	82203185	1.0	T	435.00
	2000	1997	Black aluminum	82203187	1.0	T	450.00
	2000	1997	Silver aluminum	82203186	1.0	T	450.00
	2000	1997	Black (PX8)	82202741	1.0	T	525.00
	2000	1997	Chrome	82203188	1.0	T	525.00
	2001	1997	Black (PX8)	82206478	1.0	T	550.00
GRILLE GUARDS, DELUXE — DAKOTA/DURANGO*†							
Dakota	2000	1997	Bright White (PW7)	82202980	1.0	T	525.00
	2000	1997	Chili Pepper Red (PEA)	82203796	1.0	T	525.00
	2000	1997	Deep Amethyst (PCN)	82203799	1.0	T	525.00
	2000	1997	Flame Red (PR4)	82202979	1.0	T	525.00
	2000	1997	Forest Green (PG8)	82203798	1.0	T	525.00
	2000	1997	Intense Blue (PB3)	82203800	1.0	T	525.00
	2000	1997	Light Driftwood (PFK)	82203797	1.0	T	525.00
	2001	2001	Chrome	82206465	1.0	T	545.00
Durango	2000	1998	Chili Pepper Red (PEA)	82203796	1.0	T	525.00
	2000	1998	Deep Amethyst (PCN)	82203799	1.0	T	525.00
	2000	1998	Flame Red (PR4)	82202979	1.0	T	525.00
	2000	1998	Forest Green (PG8)	82203798	1.0	T	525.00
	2000	1998	Intense Blue (PB3)	82203800	1.0	T	525.00
	2000	1998	Light Driftwood (PFK)	82203797	1.0	T	525.00
	2001	2001	Chrome	82206465	1.0	T	545.00

*If front license plate is required, order PN 52003479 separately.

†NA with Quad Cab.

HITCH RECEIVERS, QUICK REFERENCE

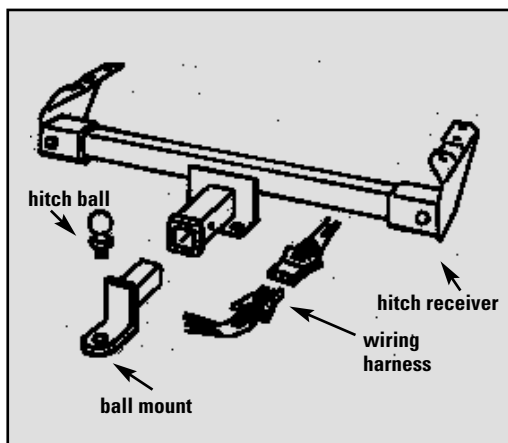

CONNECTOR TYPE	TRAILER PLUG	VEHICLE SOCKET
4-WAY CONNECTIONS (4 total wires in each plug and socket) FLAT		
7-WAY CONNECTIONS (7 total wires in each plug and socket) ROUND		
PLUG ADAPTER (7-way round to 4-way flat)		

Towing Packages

A key to successful towing is to make sure all necessary elements are there. At Mopar we don't just sell "hitches." We provide towing packages. When putting together a hitch package, it should contain the following elements:

- Hitch Receiver
- Hitch Ball (some applications)
- Ball Mount (some applications)
- Wiring Harness

Some towing situations may require additional equipment above the basic package. Some of this equipment may include:

- Heavy-Duty Electrical System
- Higher Output Engine/Transmission Components
- Engine/Transmission Oil Cooler
- Weight-Distributing (equalizing) Hitch Package
- Antisway Controls
- Electronic Trailer Braking Controls

Vehicles from the factory may come with some of this equipment already installed as part of a Trailer Tow Prep Option or may be included with your trailer equipment. Be sure to check the Owner's Manual for more information.

Weight Classes

Hitch packages, in general, are divided into four classes. Class I and Class II are usually designed to be weight-carrying with use of a ball mount. Class III and Class IV can carry heavier loads with the use of a weight-distributing hitch assembly that distributes the weight to all trailer and vehicle axles. A ball mount can also be used with Class III and Class IV Hitch Receivers for lesser loads.

Weight Carrying

Mopar weight-carrying hitch packages include Classes I, II and III. Class I has a rated capacity of up to 2,000-lb GTW. Class II is rated up to 3,500 lb. And Class III is rated up to 5,000 lb. (Not all vehicles can tow this much weight, so check the Owner's Manual for the vehicle's specific tow rating.)

Weight Distribution

Weight-distributing hitch packages are used with Class III and IV hitch packages for loads up to 6,500 lb. A weight-distributing system allows vehicles to tow heavier loads without sagging in the rear because of added trailer equipment which distributes the weight to all vehicle and trailer axles. This equipment includes a hitch head that is inserted into the hitch receiver, a hitch ball mounted to the hitch head, spring bars that connect to the hitch head to distribute the tongue weight to the trailer and vehicle axles, sway-control equipment to minimize horizontal sway, and brackets that connect the spring bars to the trailer frame.

Most trailer manufacturers have unique weight-distributing requirements for their specific trailers. Mopar hitch packages are designed to be used with most weight-distributing equipment.

NOTE: Check Owner's Manual for hitch type, load capacity and heavy-duty equipment required. Do not exceed rated tow capacity of vehicle as equipped. May require other items not supplied by Mopar.

HITCH RECEIVERS, QUICK REFERENCE (CONT.)

Mopar Hitch Receiver

Mopar Hitch Receivers have a reputation for quality unmatched in the towing industry. Here are some of the advantages built into every Mopar Hitch Receiver:

- Designed and tested in cooperation with DaimlerChrysler Corporation engineers
- Designed as a one-piece welded assembly for added strength, not a bolt-together design
- Designed to match vehicle towing capacity based on vehicle engine, driveline and suspension
- Covered with two-layered, E-coated paint finish to resist rust
- Available high-quality custom wiring harnesses to protect the vehicle's sensitive electronic equipment

Installing Packages

The proper installation of hitch packages and other towing equipment is extremely important. Mopar hitch packages are designed and tested to ensure a proper match with DaimlerChrysler Corporation vehicles, and install easily using existing vehicle frame holes.

However, failure to completely follow the installation instructions and procedures can cause hitch failure which could result in personal injury and/or vehicle damage.

Vehicle	Maximum Vehicle Tow Rating (lb)	MOPAR CLASS I HITCH PACKAGE up to 2,000-lb GTW			MOPAR CLASS III HITCH PACKAGE 3,500- to 5,000-lb GTW			MOPAR CLASS IV HITCH PACKAGE 5,000- to 6,500-lb GTW		
		Hitch Receiver	Weight-Distributing Equipment Required	Trans. Oil Cooler Recommended	Hitch Receiver	Weight-Distributing Equipment Required	Trans. Oil Cooler Recommended	Hitch Receiver	Weight-Distributing Equipment Required	Trans. Oil Cooler Recommended
Cherokee	(Check Owner's Manual for specific requirements)	YES	No	No	YES	YES	YES	Not Recommended		
Grand Cherokee	(Check Owner's Manual for specific requirements)	YES	No	No	YES	YES	Standard	YES	YES	Standard
Wrangler	(Check Owner's Manual for specific requirements)	YES	No	No	Not Recommended			Not Recommended		

Vehicle	Maximum Vehicle Tow Ratings (lb)	MOPAR CLASS I HITCH PACKAGE up to 2,000-lb GTW			MOPAR CLASS II HITCH PACKAGE 2,000- to 3,500-lb GTW		
		Hitch Receiver	Weight-Distributing Equipment Required	Trans/Oil Cooler Recommended	Hitch Receiver	Weight-Distributing Equipment Required	Trans/Oil Cooler Recommended
Caravan, Town & Country, Voyager	(Check Owner's Manual for specific requirements)	YES	No	No	YES	YES	YES

Installing Packages

The proper installation of Hitch Packages and other towing equipment is extremely important. Mopar Hitch Packages are designed and tested to ensure a proper match with DaimlerChrysler Corporation vehicles, and install easily using existing vehicle frame holes.

However, failure to completely follow the installation instructions and procedures can cause hitch failure which could result in personal injury and/or vehicle damage.

Beware of some aftermarket installers who could mount hitch packages that have a higher towing capacity than the vehicle can manage.

Vehicle	Maximum Vehicle Tow Ratings (lbs)	MOPAR CLASS IV HITCH PACKAGE 5,000- to 10,000-lb GTW		
		Hitch Receiver	Weight-Distributing Equipment Required	Trans. Oil Cooler Recommended
Ram Pickup	(Check Owner's Manual for specific requirements)	YES	YES	YES

HITCH BALL

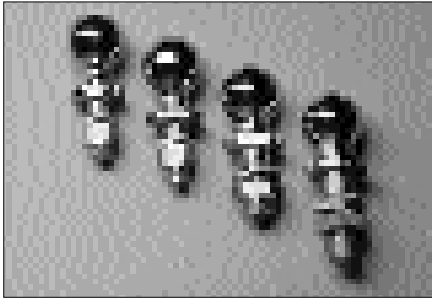

Hitch Balls



Specially designed ball for bumper

TIP: COUPLER AND HITCH BALL

The coupler is the part of the trailer that attaches to the hitch ball. The socket on the coupler should be smooth, clean and slightly lubricated. Couplers are weight rated to the trailer load (GTW) and come in various sizes.

Hitch balls are sized in three dimensions: ball diameter, shank diameter and shank length. These dimensions are used to determine the hitch ball's weight rating. When selecting a hitch ball, match the ball's weight rating and ball diameter to the trailer coupler's weight rating and size.

All Mopar hitch balls are designed with wrench flats which provide easy installation and a tighter fit.

MOPAR FEATURES	COMPETITORS?*
<ul style="list-style-type: none"> • Made of heavy-duty forged steel • Incorporated wrench flats aid in installation and removal • The chrome finish meets the 250-hour salt-spray test • Mopar Hitch Balls are designed and tested to match the vehicle's towing requirements • Mopar Accessories are covered by either the 3-year/36,000-mile New Vehicle Limited Warranty, or the 12-month/12,000-mile Mopar Basic Limited Warranty, whichever is more favorable to the customer 	<ul style="list-style-type: none"> • Is it made of forged steel? • Are wrench flats incorporated? • Does the finish meet the 250-hour salt-spray test? • Has it been tested with the vehicle? • Does the warranty compare?

*Check your market for your competitive situation.

INSTALLATION:

Use wrench to secure to Ball Mount

NOTE: Check Owner's Manual for hitch type, load capacity and heavy-duty equipment required. Do not exceed rated tow capacity of vehicle stated in Owner's Manual. May require other items not supplied by Mopar.

HITCH BALL (CONT.)

Vehicle Line	MYO	MYI	Application Remarks	Part Number	Instl Time	Group	Sugg Retail Price
HITCH BALLS*							
Passenger Car (All)	2001	1994	Chrome, 1 7/8" diameter ball, 3/4" diameter x 1 3/4" long shank, w/wrench flats, 2,000-lb tow rating, use with PN 82200248 ball mount adapter	82401104	0.1	T	16.00
Minivan (All)	2001	1996	Chrome, 1 7/8" diameter ball, 1" diameter shank, 2 1/8" long w/wrench flats	82401102	0.1	T	16.00
	2001	1996	Chrome, 1 7/8" diameter ball, 3/4" diameter x 1 3/4" long shank, w/wrench flats	82401104	0.1	T	16.00
	2001	1996	Chrome, 1 7/8" diameter ball, 3/4" diameter x 2 5/16" long shank, w/ wrench flat	82401197	0.1	T	16.00
	2001	1996	Chrome, 2" diameter ball, 1" diameter x 2 1/8" long shank, w/wrench flats	82401103	0.1	T	16.00
	2001	1996	Chrome, 2" diameter ball, 3/4" diameter x 1 3/4" long shank	82401105	0.1	T	16.00
	2001	1996	Chrome, 2 5/16" diameter ball, 1" diameter x 2 1/8" long shank w/wrench flats	82401218	0.1	T	17.00
Cherokee, Grand Cherokee	2001	1984	Chrome, 1 7/8" diameter ball, 1" diameter shank, 2 1/8" long w/wrench flats	82401102	0.1	T	16.00
	2001	1991	Chrome, 1 7/8" diameter ball, 3/4" diameter x 2 5/16" long shank, w/ wrench flat	82401197	0.1	T	16.00
	2001	1984	Chrome, 2" diameter ball, 1" diameter x 2 1/8" long shank, w/wrench flats	82401103	0.1	T	16.00
	2001	1984	Chrome, 2" diameter ball, 3/4" diameter x 1 3/4" long shank	82401105	0.1	T	16.00
Cherokee, Grand Cherokee, Wrangler	2001	1994	Chrome, 1 7/8" diameter ball, 3/4" diameter x 1 3/4" long shank, w/wrench flats	82401104	0.1	T	16.00
Grand Cherokee	2001	1999	Chrome, 2 5/16" diameter ball, 1" diameter x 2 1/8" long shank w/wrench flats	82401218	0.1	T	17.00
Durango, Ram Pickup	2001	1994	Chrome, 1 7/8" diameter ball, 1" diameter shank, 2 1/8" long w/wrench flats	82401102	0.1	T	16.00
	2001	1994	Chrome, 1 7/8" diameter ball, 3/4" diameter x 1 3/4" long shank, w/wrench flats	82401104	0.1	T	16.00
	2001	1994	Chrome, 1 7/8" diameter ball, 3/4" diameter x 2 5/16" long shank, w/ wrench flat	82401197	0.1	T	16.00
	2001	1994	Chrome, 2" diameter ball, 1" diameter x 2 1/8" long shank, w/wrench flats	82401103	0.1	T	16.00
	2001	1994	Chrome, 2" diameter ball, 3/4" diameter x 1 3/4" long shank	82401105	0.1	T	16.00
	2001	1994	Chrome, 2 5/16" diameter ball, 1" diameter x 2 1/8" long shank w/wrench flats	82401218	0.1	T	17.00
Ram Pickup (All)	2001	1994	Chrome, for step bumper use, 2" diameter ball, 1" diameter x 2 7/8" long shank	82401106	0.1	T	16.00
	2001	1994	Chrome, for step bumper use, 1 7/8" diameter ball, 1" diameter x 2 7/8" long shank, w/wrench flats	82401216	0.1	T	17.00
	2001	1994	Chrome, for step bumper use, 2 5/16" diameter ball, 1" diameter x 2 7/8" long shank, w/wrench flats	82401219	0.1	T	17.00

*NOTE: Check Owner's Manual for hitch type, load capacity and heavy-duty equipment required. Do not exceed rated tow capacity of vehicle stated in Owner's Manual. May require other items not supplied by Mopar.

HITCHES & TOWING — HITCH BALL (CONT.)

Vehicle Line	MYO	MYI	Application Remarks	Part Number	Instl Time	Group	Sugg Retail Price
HITCH BALLS (CONT.)*							
Ram Van/Wagon, Dakota (All)	2001	1994	Chrome, 1 7/8" diameter ball, 1" diameter shank, 2 1/8" long w/wrench flats	82401102	0.1	T	16.00
	2001	1994	Chrome, 1 7/8" diameter ball, 3/4" diameter x 1 3/4" long shank, w/wrench flats	82401104	0.1	T	16.00
	2001	1991	Chrome, 1 7/8" diameter ball, 3/4" diameter x 2 5/16" long shank, w/ wrench flat	82401197	0.1	T	16.00
	2001	1994	Chrome, 2" diameter ball, 1" diameter x 2 1/8" long shank, w/wrench flats	82401103	0.1	T	16.00
	2001	1986	Chrome, 2" diameter ball, 3/4" diameter x 1 3/4" long shank	82401105	0.1	T	16.00
	2001	1994	Chrome, 2 5/16" diameter ball, 1" diameter x 2 1/8" long shank w/wrench flats	82401218	0.1	T	17.00

*NOTE: Check Owner's Manual for hitch type, load capacity and heavy-duty equipment required. Do not exceed rated tow capacity of vehicle stated in Owner's Manual. May require other items not supplied by Mopar.

HITCH RECEIVERS

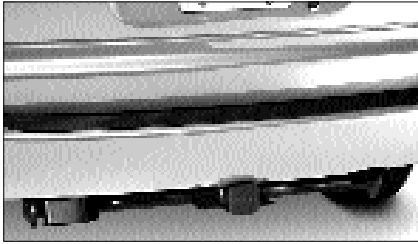

Minivan Class I

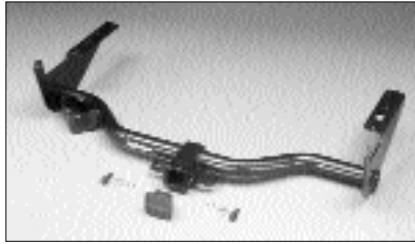

Minivan Class II



Intrepid Hitch Assembly



Neon Hitch Assembly



Grand Cherokee

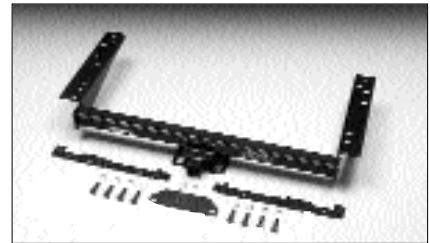

Grand Cherokee Laredo



Wrangler

Vehicle Line	MY0	MY1	Application Remarks	Part Number	Instl Time	Group	Sugg Retail Price
HITCH RECEIVERS*							
300M	2001	1999	2,000-lb tow rating and 200-lb tongue weight rating; includes ball mount, pin and clip; 1.25" opening	82204771	1.0	T	143.00
Breeze, Cirrus, Stratus	2000	1995	1,000-lb tow rating; 100-lb tongue weight rating; includes ball mount, pin and clip; 1.25" opening	82300802	0.5	T	130.00
Cherokee	2001	1990	2,000-lb tow rating and 200-lb tongue weight rating; includes Ball Mount, 1 1/4" opening	82202852	0.8	T	169.00
	2001	1987	5,000-lb tow rating and 750-lb tongue weight rating (based on load equalizing use), does not include Ball Mount or Hitch Ball, 2.0" opening	82204709	0.8	T	179.00
Concorde, LHS	2001	1998	2,000-lb tow rating; 200-lb tongue weight rating; includes ball mount, pin and clip; 1.25" opening	82203649	1.0	T	143.00
Dakota (All)	2000	1997	6,500-lb tow rating and 750-lb tongue weight rating w/load equalizing hitch, or 3,500-lb tow rating and 350-lb tongue weight rating w/Ball Mount and Hitch Ball, does not include Ball Mount or Hitch Ball w/o valance panel	82204712	0.4	T	157.00
	2001	1997	5,000-lb tow rating and 500-lb tongue weight rating w/load equalizing hitch, or 3,500-lb tow rating and 350-lb tongue weight rating w/Ball Mount and Hitch Ball, does not include Ball Mount or Hitch Ball	82204713	0.6	T	162.00
Durango	2001	1998	2,000-lb tow rating, 200-lb tongue weight rating, includes Ball Mount, Hitch Ball not included, 1 1/4" opening	82205849	0.8	T	162.00
	2001	1998	7,000-lb tow rating, 750-tongue weight rating with weight distributing equipment, otherwise 3,500-lb tow rating, 350-lb tongue weight rating, does not include Ball Mount or Hitch Ball, for vehicles w/closed box near frame, 2.0" opening	82204714	0.8	T	215.00

HITCH RECEIVERS (CONT.)

Vehicle Line	MY0	MY1	Application Remarks	Part Number	Instl Time	Group	Sugg Retail Price
HITCH RECEIVERS* (CONT.)							
Grand Cherokee	2001	2000	5,000-lb tow rating and 750-lb tongue weight w/6-cyl engine, and 6,500-lb tow rating and 750-lb tongue weight rating w/V8 engine (based on load equalizing use); requires Trailer Tow Prep Package, see Owner's Manual for requirements; does not include Ball Mount Adapter or Hitch Ball; same as OE hitch, 2.0" opening	82206837 [†]	0.7	T	169.00
Intrepid	2001	1998	2,000-lb tow rating; 200-lb tongue weight rating; includes chrome ball mount, pin and clip; 1.25" opening	82203648	1.0	T	143.00
Minivan (All)	2000	1996	2000-lb tow rating, 200-lb tongue weight rating, includes Ball Mount, pin and clip, 1.25" opening	82204461	0.5	T	143.00
	2000	1996	3,500-lb tow rating, 300-lb tongue weight rating	82204464	0.5	T	157.00
	2001	2001	3,800-lb tow rating, 380-LB Tongue weight rating, includes Ball Mount, pin and clip, does not include Hitch Ball; 2.00" opening	82206648	0.5	T	179.00
	2001	2001	2,000-lb tow rating and 200-lb tongue weight rating, includes Ball Mount, pin and clip, does not include Hitch Ball, 1.25" opening	82206647	0.5	T	195.00
Neon	2000	2000	1,000-lb tow rating and 100-lb tongue weight rating; includes ball mount, pin and clip; 1.25" opening, will not fit vehicles w/dual tip exhaust	82204734	0.7	T	143.00
	2001	2000	1,000-lb maximum towing capacity and 100-lb tongue weight rating, includes Ball Mount, pin and clip. 1.25" opening	82205890	0.7	T	143.00
Prowler	2001	1998	1,000-lb tow rating, 100-lb tongue weight rating, includes Ball Mount, pin and clip, 1.25" opening	82202817	1.5	T	225.00
PT Cruiser	2001	2001	1,000-lb tow rating and 100-lb tongue weight rating; includes ball mount, pin and clip; 1.25" opening	82204770	0.7	T	164.00
Ram Pickup (All)	2001	1994	10,000-lb tow rating and 1,000-lb tongue weight rating w/load equalizing hitch, or 5,000-lb tow rating and 500-lb tongue weight rating, w/wire harness bracket, 2.0" opening	82206538	0.7	T	169.00
Ram Van/Wagon	2000	1998	W/o bumper, 10,000-lb tow rating and 1,000-lb tongue weight rating w/load equalizing hitch, or 3500-lb tow rating and 350-lb tongue weight rating w/Ball Mount and Hitch Ball, does not include Ball Mount or Hitch Ball, 2.0" wide opening	82204710	0.8	T	200.00
	2000	1998	W/ step bumper, 10,000-lb tow rating and 1,000-lb tongue weight rating w/load equalizing hitch, or 3500-lb tow rating and 350-lb tongue weight rating w/Ball Mount and Hitch Ball, does not include Ball Mount or Hitch Ball, 2.0" wide opening	82204711	0.8	T	210.00
	2001	2001	10,000-lb tow rating and 1,000-lb tongue weight rating with load equalizing hitch, or 5,000-lb tow rating and 500-lb tongue weight rating with Ball Mount and Hitch Ball, 2.0" opening	82205981	0.8	T	210.00
Sebring Convertible	2000	1996	2,000-lb tow rating and 200-lb tongue weight rating w/6-cyl; 1,500-lb tow rating and 150-lb tongue weight rating w/4-cyl; includes ball mount, pin and clip, 1.25" opening	82202051	0.7	T	143.00
	2001	2001	1,000-lb tow rating and 100-lb tongue weight rating, includes ball mount, pin and clip, 1.25" opening	82206038 [†]	0.7	T	143.00
Sebring Sedan, Stratus Sedan	2001	2001	1,000-lb tow rating and 100-lb tongue weight rating; includes ball mount, pin and clip, 1.25" opening, for sedans only	82206521	0.7	T	143.00
Wrangler	2001	1997	2,000-lb capacity, w/6-cyl, 1,000-lb capacity w/4-cyl, Black, includes Ball Mount and 1 7/8" Hitch Ball, 1.25" opening	82204119	0.3	T	139.00

*NOTE: Check Owner's Manual for hitch type, load capacity and heavy-duty equipment required. Do not exceed rated tow capacity of vehicle stated in Owner's Manual. May require other items not supplied by Mopar.

[†] Requires rear fascia bezel for installation.

HITCH RECEIVERS, BALL MOUNT KIT



Hitch Ball Mount

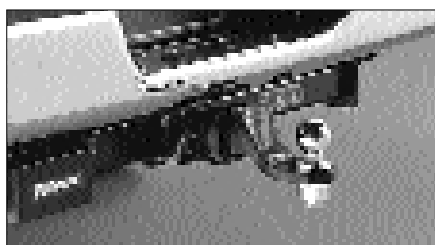

Hitch Ball Mount, Ball sold separately



In drop position



(Top) 1.75" drop, (Bottom) 2.25" drop

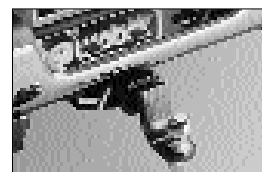

(Top) 2.75" drop (Bottom) 3.50" rise

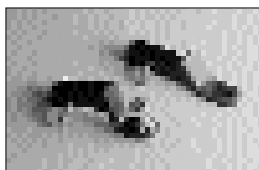

3" Drop (Left), 2.75" Drop (Right)

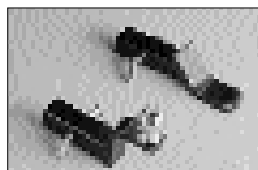

3.50" Rise (Left), 1" Drop (Right)

MOPAR FEATURES

- Made of heavy-duty cold-rolled steel
- Matches hitch opening, no cutting required
- Electrocoat primer and powder-coat paint provide a durable finish on Class II adapters
- Mopar Ball Mounts are designed and tested to match the vehicle's towing capacity
- Mopar Ball Mounts are designed to match the vehicle's towing capability; maximum tow rating: 5,000 lb; maximum tongue weight rating: 500 lb
- Mopar Accessories are covered by either the 3-year/36,000-mile New Vehicle Limited Warranty, or the 12-month/12,000-mile Mopar Basic Limited Warranty, whichever is more favorable to the customer

COMPETITORS?*

- Is it made of heavy-duty rolled steel, or is it made of stamped steel, which is weaker?
- Is it a universal fit? Does it require cutting?
- Does it have an E-coat/powder-coat finish, or an enamel finish, which may chip, scratch and rust easily?
- Has the ball mount been tested to the rating specified?
- Has it been tested with the vehicle?
- Does the warranty compare?

*Check your market for your competitive situation.

HITCHES & TOWING — HITCH RECEIVERS, BALL MOUNT KIT (CONT.)

Vehicle Line	MYO	MYI	Application Remarks	Part Number	Instl Time	Group	Sugg Retail Price
HITCH RECEIVERS — BALL MOUNT KITS*							
Cherokee, Grand Cherokee	2001	1987	1.75" rise, 1" drop; use with 1" shank diameter Hitch Ball, for 2" hitch opening	82201148	0.1	T	33.00
	2001	1984	3" rise, 2.25" drop; use with 1" shank diameter Hitch Ball, for 2" hitch opening	82201149	0.1	T	33.00
	2001	1990	3.50" rise, 2.75" drop, use only with .75" shank diameter Hitch Ball, for 2.0" hitch opening	82200248	0.1	T	33.00
Durango, Ram Pickup	2001	1994	1.75" rise, 1" drop; use with 1" shank diameter Hitch Ball, for 2" hitch opening	82201148	0.1	T	33.00
	2001	1994	3" rise, 2.25" drop; use with 1" shank diameter Hitch Ball, for 2" hitch opening	82201149	0.1	T	33.00
	2001	1994	3.50" rise, 2.75" drop, use only with .75" shank diameter Hitch Ball, for 2.0" hitch opening	82200248	0.1	T	33.00
Minivan (All)	2001	1996	1.75" rise, 1" drop; use with 1" shank diameter Hitch Ball, for 2" hitch opening	82201148	0.1	T	33.00
	2001	1996	3" rise, 2.25" drop; use with 1" shank diameter Hitch Ball, for 2" hitch opening	82201149	0.1	T	33.00
	2000	1996	3.50" rise, 2.75" drop, use only with .75" shank diameter Hitch Ball, for 2.0" hitch opening	82200248	0.1	T	33.00
	2001	1996	Use w/3/4" shank diameter Hitch Ball (replacement for PN 82300356-7-8), PN 82300801, PN 4549277, PN 4549278 minivan Class I hitches w/ 1 1/4 receiver opening)	04549284	0.1	T	33.00
Neon	2001	1995	Use w/3/4" shank diameter Hitch Ball (replacement for PN 82300356-7-8), PN 82300801, PN 4549277, PN 4549278 minivan Class I hitches w/ 1 1/4 receiver opening)	04549284	0.1	T	33.00
Ram Van/Wagon, Dakota (All)	2001	1990	1.75" rise, 1" drop; use with 1" shank diameter Hitch Ball, for 2" hitch opening	82201148	0.1	T	33.00
	2001	1990	3" rise, 2.25" drop; use with 1" shank diameter Hitch Ball, for 2" hitch opening	82201149	0.1	T	33.00
	2001	1990	3.50" rise, 2.75" drop, use only with .75" shank diameter Hitch Ball, for 2.0" hitch opening	82200248	0.1	T	33.00

*NOTE: Check Owner's Manual for hitch type, load capacity and heavy-duty equipment required. Do not exceed rated tow capacity of vehicle stated in Owner's Manual. May require other items not supplied by Mopar.

HITCH RECEIVERS, INSTALLATION BEZELS & QUANTITY DISCOUNT PURCHASES

Vehicle Line	MY0	MY1	Application Remarks	Part Number	Instl Time	Group	Sugg Retail Price
HITCH RECEIVERS — QUANTITY DISCOUNT PURCHASES*							
Cherokee	2001	1987	5,000-lb tow rating and 750-lb tongue weight rating, load equalizing hitch, does not include Ball Mount Adapter or Hitch Ball, a pallet consists of 20 hitches per PN 82204074 w/20 hardware mounting kits, same as PN 82204709 hitch	82204074 [†]	0.6		
Dakota (All)	2000	1997	6,500-lb tow rating and 750-lb tongue weight rating w/load equalizing hitch, does not include Ball Mount Adapter or Hitch Ball, a pallet consists of 20 hitches per part number (PN 82206356) with 20 hardware mounting kits	82206357 [†]	0.4		
Grand Cherokee	2001	1999	5,000-lb tow rating and 750-lb tongue weight rating, does not include Ball Mount Adapter or Hitch Ball, a pallet consists of 10 hitches per PN 82206837 w/10 hardware mounting kits	82206838 [†]	0.7		
Ram Pickup (All)	2001	1994	10,000-lb tow rating and 1,000-lb tongue weight rating w/load equalizing hitch, does not include Ball Mount Adapter or Hitch Ball, a pallet consists of 12 hitches per part number with 12 hardware mounting kits	82206537 [†]	0.4		
Wrangler	2001	1997	2,000-lb (6-cyl) tow rating and 1,000-lb (4-cyl) tow rating hitches, includes Ball Mount Adapter and Hitch Ball, a pallet consists of 20 hitches per part number w/20 hardware mounting kits, same as PN 82204119 hitch	82204123 [†]	0.6		
HITCH RECEIVERS — INSTALLATION BEZELS*							
Grand Cherokee	2001	1999	Black, use on Limited	82204628	0.2	T	65.00
	2001	2001	Dark Blue Metallic (YBM), matches Laredo cladding	82206826	0.2	T	65.00
	2001	2001	Dark Garnet Red (YR8), matches Laredo cladding	82206827	0.2	T	65.00
	2001	1999	Medium Driftwood (VF7), matches Laredo cladding	82204630	0.2	T	65.00
	2001	2000	Dark Gray (XS9), matches Laredo cladding	82205791	0.2	T	65.00

*NOTE: Check Owner's Manual for hitch type, load capacity and heavy-duty equipment required. Do not exceed rated tow capacity of vehicle stated in Owner's Manual. May require other items not supplied by Mopar.

[†] Allow up to three weeks production/shipping time from date of order entry.

HITCH RECEIVERS, RECEIVER PLUG



Receiver Plug with Mopar logo



Receiver Plug with Dodge Ram's Head logo



Receiver Plug with Jeep logo

MOPAR FEATURES

- Santoprene® material won't harden, crack, chalk or discolor
- Helps to protect hitch opening from dirt, mud and water
- Features Mopar, Dodge or Jeep logo
- Santoprene will not shrink in extreme cold
- Molded rubber (Santoprene®) retains its color and durability
- Mopar Accessories are covered by either the 3-year/36,000-mile New Vehicle Limited Warranty or the 12-month/12,000-mile Mopar Basic Limited Warranty, whichever is more favorable to the customer

COMPETITORS?*

- Has it been tested for durability in cold weather?
- Will the plug crack or discolor?
- Mopar, Dodge and Jeep logos are exclusive to DaimlerChrysler Corporation, Dodge, Jeep and Mopar
- Does the warranty compare?

*Check your market for your competitive situation.
Santoprene is a registered trademark of Monsanto Corporation.

Vehicle Line	MYO	MYI	Application Remarks	Part Number	Instl Time	Group	Sugg Retail Price
HITCH RECEIVERS — RECEIVER PLUGS							
Breeze, Cirrus, Stratus, Sebring Sedan & Conv., Stratus Sedan, Sebring Convertible, Concorde, Intrepid, LHS, 300M, Neon, PT Cruiser	2001	1993	Fits 1 1/4" receiver w/Mopar Logo	82203603	D.I.Y.	T	9.25
Cherokee	2001	1984	Fits 1 1/4" receiver w/Mopar Logo	82203603	D.I.Y.	T	9.25
Cherokee, Grand Cherokee	2001	1984	Fits 2.0" Hitch Receiver, w/Jeep logo	82203600	D.I.Y.	T	10.00
	2001	1984	Fits 2.0" receiver w/Mopar Logo	82203602	D.I.Y.	T	10.00
Cherokee, Wrangler	2001	1984	Fits 1 1/4" Hitch Receiver, w/Jeep logo	82205191	D.I.Y.	T	10.00
Durango, Ram Pickup	2001	1994	Fits 2.0" receiver w/Mopar Logo	82203602	D.I.Y.	T	10.00
	2001	1994	Fits 2.0" receiver w/Rams Head Logo	82203601	D.I.Y.	T	10.00
Minivan (All)	2001	1996	Fits 1 1/4" receiver w/Mopar Logo	82203603	D.I.Y.	T	9.25
	2001	1996	Fits 2.0" receiver w/Mopar Logo	82203602	D.I.Y.	T	10.00
Ram Van/Wagon, Dakota (All)	2001	1971	Fits 2.0" receiver w/Mopar Logo	82203602	D.I.Y.	T	10.00
	2001	1971	Fits 2.0" receiver w/Rams Head Logo	82203601	D.I.Y.	T	10.00

HITCH RECEIVERS, WIRING HARNESSES, BRACKETS & ADAPTERS



PN 82204725, PN 82203412



PN 82400554



PN 82401217



Adapter PN 56019823



(82204638, 82204639, 82301020, 82204441)



PN 822202089



Trailer Wiring Harness
PN 82204644

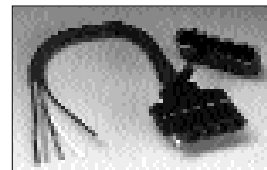

Replacement 5-way flat
wiring kit



(82300968, 82203243)



Harness Kit
82401264/82203407

MOPAR FEATURES

- OE wire connectors, no splicing
- Protective wrapping guards against weather and abrasion
- Custom fit to DaimlerChrysler Corporation wiring configurations
- Mopar Accessories are covered by either the 3-year/36,000-mile New Vehicle Limited Warranty or the 12-month/12,000-mile Mopar Basic Limited Warranty, whichever is more favorable to the customer

COMPETITORS?*

- Is it a universal fit, which may require splicing? Are crimp connectors required for installation, which may cause nicked wires or wire corrosion? Will wires vibrate loose?
- Are wires protected from road salt and debris?
- Does the warranty compare?

*Check your market for your competitive situation.

HITCH RECEIVERS, WIRING HARNESES, BRACKETS & ADAPTERS (CONT.)

Vehicle Line	MYO	MYI	Application Remarks	Part Number	Instl Time	Group	Sugg Retail Price
WIRING HARNESES — REPAIR KITS, BRACKETS & ADAPTERS*							
Avenger, Sebring Coupe, Breeze, Cirrus, Stratus, Sebring Convertible, Concorde, Intrepid, LHS, 300M, Neon, Prowler, PT Cruiser, Viper	2000	1990	Trailer Side Replacement Wiring Kit, 5-way flat connector with 5 unterminated 8.0" wires, mates w/all Mopar Trailer Tow 5-way Wire Harnesses	82400553	0.3	T	15.00
	2000	1976	Replacement Wiring Kit, 5-way flat connector with 5 unterminated 8.0" wires, mates w/PN 82400553 Trailer Tow Wire Harness	82400709	0.3	T	19.75
Breeze, Cirrus, Stratus, Sebring Sedan & Conv., Stratus Sedan, Sebring Convertible, Concorde, Intrepid, LHS, 300M, Neon, Prowler, PT Cruiser	2001	1993	Trailer Tow Bracket Kit to mount 4-Way Flat Trailer Tow Connector	82204602	0.2	T	5.15
	2001	1993	Vehicle and Trailer Side Repair Kit, 4-way flat connector	82202089	0.3	T	7.00
Cherokee	2001	1992	Adapter, converts 7-way round to 6-way round connector (vehicle side)	82401217	D.I.Y.	T	14.00
Cherokee, Grand Cherokee	2001	1984	Trailer Side Replacement Wiring Kit, 7-way round connector with 7 unterminated 8.0" wires, mates w/Mopar 7-way Trailer Tow Wire Harness	82400554	0.3	T	23.00
Cherokee, Grand Cherokee, Wrangler	2001	1996	Trailer Tow Bracket Kit, 7-way round connector	82204645	0.2	T	8.00
	2000	1990	Trailer Side Replacement Wiring Kit, 5-way flat connector with 5 unterminated 8.0" wires, mates w/all Mopar Trailer Tow 5-way Wire Harnesses	82400553	0.3	T	15.00
	2000	1976	Replacement Wiring Kit, 5-way flat connector with 5 unterminated 8.0" wires, mates w/PN 82400553 Trailer Tow Wire Harness	82400709	0.3	T	19.75
Durango, Ram Pickup	2001	1994	Trailer Side Replacement Wiring Kit, 7-way round connector with 7 unterminated 8.0" wires, mates w/Mopar 7-way Trailer Tow Wire Harness	82400554	0.3	T	23.00
Durango, Ram Pickup	2001	1994	Trailer Tow Bracket Kit to mount 4-Way Flat Trailer Tow Connector	82204602	0.2	T	5.15
	2001	1994	Vehicle and Trailer Side Repair Kit, 4-way flat connector	82202089	0.3	T	7.00
	2001	1996	Trailer Tow Bracket Kit, 7-way round connector	82204645	0.2	T	8.00
	2001	1994	Adapter, converts 7-way round to 4-way flat connector	56019823	D.I.Y.	T	14.00
	2001	1994	Adapter, converts 7-way round to 6-way round connector (vehicle side)	82401217	D.I.Y.	T	14.00

*NOTE: Check Owner's Manual for hitch type, load capacity and heavy-duty equipment required. Do not exceed rated tow capacity of vehicle stated in Owner's Manual. May require other items not supplied by Mopar.

HITCH RECEIVERS, WIRING HARNESSES, BRACKETS & ADAPTERS (CONT.)

Vehicle Line	MYO	MYI	Application Remarks	Part Number	Instl Time	Group	Sugg Retail Price
WIRING HARNESSES — REPAIR KITS, BRACKETS & ADAPTERS*							
Durango, Ram Pickup	2000	1990	Trailer Side Replacement Wiring Kit, 5-way flat connector with 5 unterminated 8.0" wires, mates w/all Mopar Trailer Tow 5-way Wire Harnesses	82400553	0.3	T	15.00
	2000	1976	Replacement Wiring Kit, 5-way flat connector with 5 unterminated 8.0" wires, mates w/PN 82400553 Trailer Tow Wire Harness	82400709	0.3	T	19.75
Minivan (All)	2001	1996	Trailer Tow Bracket Kit to mount 4-Way Flat Trailer Tow Connector	82204602	0.2	T	5.15
	2001	1996	Vehicle and Trailer Side Repair Kit, 4-way flat connector	82202089	0.3	T	7.00
	2001	1996	Trailer Tow Bracket Kit, 7-way round connector	82204645	0.2	T	8.00
	2001	1996	Adapter, converts 7-way round to 4-way flat connector	56019823	D.I.Y.	T	14.00
	2001	1996	Adapter, converts 7-way round to 6-way round connector (vehicle side)	82401217	D.I.Y.	T	14.00
	2000	1990	Trailer Side Replacement Wiring Kit, 5-way flat connector with 5 unterminated 8.0" wires, mates w/all Mopar Trailer Tow 5-way Wire Harnesses	82400553	0.3	T	15.00
	2000	1976	Replacement Wiring Kit, 5-way flat connector with 5 unterminated 8.0" wires, mates w/PN 82400553 Trailer Tow Wire Harness	82400709	0.3	T	19.75
Passenger Cars (All)	2001	1996	Trailer Tow Bracket Kit, 7-way round connector	82204645	0.2	T	8.00
	2001	1996	Trailer Side Replacement Wiring Kit, 7-way round connector with 7 unterminated 8.0" wires, mates w/Mopar 7-way Trailer Tow Wire Harness	82400554	0.3	T	23.00
Ram Van/Wagon, Dakota (All)	2001	1992	Trailer Tow Bracket Kit to mount 4-Way Flat Trailer Tow Connector	82204602	0.2	T	5.15
	2001	1992	Vehicle and Trailer Side Repair Kit, 4-way flat connector	82202089	0.3	T	7.00
	2001	1996	Trailer Tow Bracket Kit, 7-way round connector	82204645	0.2	T	8.00
	2001	1986	Adapter, converts 7-way round to 4-way flat connector	56019823	D.I.Y.	T	14.00
	2001	1992	Adapter, converts 7-way round to 6-way round connector (vehicle side)	82401217	D.I.Y.	T	14.00
	2000	1990	Trailer Side Replacement Wiring Kit, 5-way flat connector with 5 unterminated 8.0" wires, mates w/all Mopar Trailer Tow 5-way Wire Harnesses	82400553	0.3	T	15.00
	2000	1976	Replacement Wiring Kit, 5-way flat connector with 5 unterminated 8.0" wires, mates w/PN 82400553 Trailer Tow Wire Harness	82400709	0.3	T	19.75
Wrangler	2001	1997	Trailer Side Replacement Wiring Kit, 7-way round connector with 7 unterminated 8.0" wires, mates w/Mopar 7-way Trailer Tow Wire Harness	82400554	0.3	T	23.00
	2001	1997	Trailer Tow Bracket Kit to mount 4-Way Flat Trailer Tow Connector	82204602	0.2	T	5.15
	2001	1997	Vehicle and Trailer Side Repair Kit, 4-way flat connector	82202089	0.3	T	7.00

*NOTE: Check Owner's Manual for hitch type, load capacity and heavy-duty equipment required. Do not exceed rated tow capacity of vehicle stated in Owner's Manual. May require other items not supplied by Mopar.

HITCHES & TOWING — WIRING HARNESES, TRAILER TOWING PACKAGES

Vehicle Line	MYO	MYI	Application Remarks	Part Number	Instl Time	Group	Sugg Retail Price
WIRING HARNESES — TRAILER TOWING PACKAGES*							
Breeze, Cirrus, Stratus	2000	2000	Trailer Tow Wire Harness Kit w/4-way flat connector, plugs directly into the vehicle	82205825	0.5		87.00
Cherokee	2001	1997	Trailer Tow Wire Harness Kit, 7-way round trailer connector, plugs directly into vehicle	82204634	0.5		46.00
Concorde LX, Intrepid, 300M	2001	1998	Trailer Tow Wire Harness Kit w/4-way flat connector, plugs directly into the vehicle's wiring, no splicing required	82204638	0.5		86.00
Dakota (All)	2001	1995	Trailer Tow Wire Harness Kit, 4-way flat trailer connector. Plugs directly into vehicles wiring, no splicing required	82204641	0.4		50.00
	2000	1995	Trailer Tow Wire Harness Kit, 7-way round trailer connector, plugs directly into vehicles wiring, includes external running light relay	82204724	0.8		100.00
Durango	2000	1998	Trailer Tow Wire Harness Kit, 7-way round trailer connector, plugs directly into vehicles wiring, no splicing required, includes external running light relay	82204091	0.8		109.00
	2001	1998	Trailer Tow Wire Harness Kit, 4-way flat trailer connector, plugs directly into vehicle	82204640	0.4		67.00
Grand Cherokee	2000	1999	Trailer Tow Wire Harness Kit, 7-way round trailer connector, plugs into 10-way connector	82204725	1.0		48.00
	2001	2001	Trailer Tow Wire Harness Kit, 7-way round trailer connector, plugs into 10-way connector	82206958	1.0		48.00
LHS	2001	1999	Trailer Tow Wire Harness Kit w/4-way flat connector, plugs directly into the vehicle	82204639	0.5		86.00
Minivan (All)	2001	2001	Trailer Tow Wire Harness Kit, 7-way round connector	82206301	0.8		109.00
	2000	1996	Trailer Tow Wire Harness Kit, 4-way flat trailer connector, plugs directly into vehicle	82204640	0.4		67.00
	2001	2001	Trailer Tow Wire Harness Kit, 4-way flat connector	82206300	0.4		59.00
	2001	2001	Trailer Tow Wire Harness Kit, 7-way round trailer connector, plugs into 10-way connector	82206958	1.0		48.00
	2000	1996	Trailer Tow Wire Harness Kit, 7-way flat trailer connector, plugs directly into vehicle	82204721	0.8		109.00
Neon	2001	1995	Trailer Tow Wire Harness Kit w/4-way flat connector, splicing required	82205158	0.5		38.00
Prowler	2001	1997	Trailer Tow Wiring Harness Kit, 4-way flat trailer tow connector, plugs into vehicle	82203243	0.2	T	50.00
PT Cruiser	2001	2001	Trailer Tow Wire Harness Kit w/4-way flat connector, splicing required	82206024	0.5		97.00
Ram Pickup (All)	2001	1995	Trailer Tow Wire Harness Kit, 4-way flat trailer connector. Plugs directly into vehicles wiring, no splicing required	82204641	0.4		50.00
	2001	1995	Trailer Tow Wire Harness Kit, 7-way round trailer connector, plugs directly into vehicles wiring, includes external running light relay	82204724	0.8		100.00
Ram Van/Wagon	2001	2001	4-way flat connector, plugs directly into vehicle	82206533	0.4		26.00
	2000	1999	Trailer Tow Wire Harness Kit, 4-way flat trailer tow connector, plugs directly into vehicles wiring, no splicing required	82205083	0.4		34.00
	2000	1999	Trailer Tow Wire Harness Kit, 7-way round trailer connector, plugs directly into vehicles wiring, no splicing required	82205080	0.8		66.00
	2001	2001	7-way round trailer connector, plugs directly into vehicle	82206531	0.8		72.00

*NOTE: Check Owner's Manual for hitch type, load capacity and heavy-duty equipment required. Do not exceed rated tow capacity of vehicle stated in Owner's Manual. May require other items not supplied by Mopar.

HITCHES & TOWING — WIRING HARNESES, TRAILER TOWING PACKAGES (CONT.)

Vehicle Line	MYO	MYI	Application Remarks	Part Number	Instl Time	Group	Sugg Retail Price
WIRING HARNESES — TRAILER TOWING PACKAGES* (CONT.)							
Sebring Convertible	2000	1998	Trailer Tow Wire Harness Kit w/4-way flat connector, plugs directly into vehicle's wiring w/no splicing required, for vehicles produced after Dec. 11, 1997; fits vehicles in which only the outboard bulb flashes when turn signal is activated	82204637	0.5		97.00
Sebring Sedan & Conv., Stratus Sedan, Sebring Convertible	2001	1998	Trailer Tow Wiring Harness, 4-way flat trailer connector, plugs directly into vehicle	82206629	0.5		97.00
Wrangler	2001	1998	Trailer Tow Wire Harness Kit, 4-way flat trailer connector, plugs directly into vehicle	82204644	0.4		38.00

*NOTE: Check Owner's Manual for hitch type, load capacity and heavy-duty equipment required. Do not exceed rated tow capacity of vehicle stated in Owner's Manual. May require other items not supplied by Mopar.

INTERIOR TRIM APPLIQUES



Instrument Panel Applique (shown in Intrepid)



Grand Cherokee Laredo



Cherokee



Ram Pickup



Durango

MOPAR FEATURES

- Custom designed to fit the instrument panel, gauges, vents and pockets
- Installed with DaimlerChrysler Corporation-approved adhesives for a secure fit
- Adhesive promoter and cleaning chemical kit included for convenient installation
- Enhances interior appearance
- Approved by DaimlerChrysler Vehicle Design Team
- Mopar Accessories are covered by either the 3-year/36,000-mile New Vehicle Limited Warranty, or the 12-month/12,000-mile Mopar Basic Limited Warranty, whichever is more favorable to the customer

COMPETITORS?*

- Does it fit the instrument panel exactly or does it have to be trimmed?
- Do adhesives meet DaimlerChrysler Corporation standards?
- Will they hold up?
- Do you have to source separate installation chemicals, not readily available in your shop?
- Does it meet DaimlerChrysler Corporation design standards?
- Does the warranty compare?

*Check your market for your competitive situation.

INSTALLATION:

- Attaches with DaimlerChrysler Corporation approved adhesive tape
- Adhesive promoter and cleaner kit included, no other products needed for installation
- Easy to install
- No special tools needed

INTERIOR TRIM APPLIQUES (CONT.)

Vehicle Line	MYO	MYI	Application Remarks	Part Number	Instl Time	Group	Sugg Retail Price
INTERIOR TRIM APPLIQUES							
Avenger	2000	1995	Rosewood, 7 pieces (pieces for vehicles with standard A/C and w/o heated seats)	82202403	0.5	T	270.00
Cherokee	2001	1997	Rosewood, instrument panel, 5 pieces	82203253	0.4	T	280.00
Dakota (All)	2000	1999	Rosewood, instrument and door panels, 4 pieces	82204804	0.4	T	275.00
Dakota 4x2	2000	2000	Burlwood, 6 pieces	82205680	0.4	T	400.00
Dakota 4x4	2001	2001	Burlwood, instrument panel, 5 pieces	82206684	0.5	T	265.00
	2000	2000	Burlwood, 6 pieces	82205352	0.4	T	400.00
Durango	2000	1999	Rosewood, instrument and door panels, bench seat 4WD, 7 pieces	82204783	0.4	T	345.00
Durango 4x2	2000	2000	Burlwood, 6 pieces	82205680	0.4	T	400.00
Durango 4x4	2001	2001	Burlwood, 5 pieces	82206704	0.5	T	265.00
	2000	2000	Burlwood, 6 pieces	82205352	0.4	T	400.00
Grand Cherokee	2001	2000	Spartan Burlwood, door panels, 8 pieces	82205770	0.3	T	182.00
Grand Cherokee Laredo	2001	2000	Spartan Burlwood, instrument panel (pieces for vehicles with standard A/C and w/heated seats)	82205769	0.4	T	240.00
	2001	2000	Spartan Burlwood, instrument panel (pieces for vehicles with standard A/C and w/o heated seats)	82205768	0.4	T	240.00
Intrepid	2001	1998	Rosewood, instrument panel, w/ or w/o AutoStick	82205710	0.4	T	210.00
Ram Pickup (All)	2001	1999	Rosewood, instrument panels, 3 pieces, for vehicles equipped with A/C and heated power mirror	82204737	0.4	T	245.00
Ram Pickup - Club or Quad Cab	2001	1998	Rosewood, door panels, 4 pieces	82204511	0.4	T	136.00
Ram Pickup - Regular Cab (All)	2000	1994	Rosewood, door panels, 6 pieces	82204510	0.4	T	175.00

LIGHT BAR, JEEP®



Light Bar (shown on Wrangler)



Light Bar with Off-Road Lamps, prewired (shown on Wrangler)



Prewired for two or four-light installation

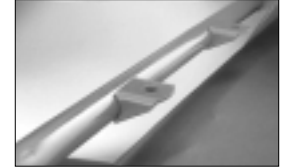

Light mounting tab

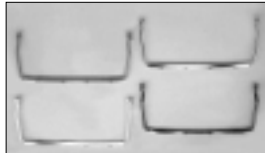

Four finishes available: Black painted steel, Black or Silver aluminum or chrome



Shown with new style Mopar Off-Road Light and Brush Cover

MOPAR FEATURES

- Anodized aluminum resists corrosion, pitting, peeling, and is scratch resistant
- E-coat primer and powder-coat paint provide a durable finish
- Chrome is designed to meet 44-hour Chrome Accelerated Salt Spray test — a DaimlerChrysler Corporation standard
- Bright hexavalent chrome finish
- The chrome finish consists of .001-ductile nickel base coating for strength, covered by .0005-semi-bright nickel seal coat and topped with hexavalent chrome plating that will provide a bright, rust-resistant product
- Mopar uses stainless steel fasteners and hardware
- Designed specifically to match the slope of Wrangler's windshield
- Uses windshield hinge mount for a strong, durable installation
- Mandrel tube bending provides a neat, clean, finished appearance
- Authentic Jeep® design
- Product designed by the creators of the Jeep Wrangler
- Matches other Mopar tubular accessories
- Prewired to eliminate difficult fishing of wires through narrow tubes
- Design allows normal soft top operation
- Mopar Accessories are covered by either the 3-year/36,000-mile New Vehicle Limited Warranty, or the 12-month/12,000-mile Mopar Basic Limited Warranty, whichever is more favorable to the customer

COMPETITORS?*

- Is it anodized aluminum?
- Will it pit or corrode?
- Does it have an E-coat/powder-coat finish, or an enamel finish, which may chip, scratch and rust easily?
- Does the chrome finish meet Mopar's standards for durability?
- Is it a "duller" cadmium chrome finish?
- Are plain steel fasteners used, which may rust?
- Is all hardware stainless steel?
- Is it a universal fit?
- Is it a hang-on design?
- Are tubes bent without mandrel, resulting in a flat, wrinkled appearance?
- Mopar Accessories are the only genuine Jeep vehicle-designed products available for Wrangler
- Does light bar require wire installation; a nasty, time-consuming job?
- Will light bar interfere with "swing" of soft top when opened or closed?
- Does the warranty compare?

*Check your market for your competitive situation.

INSTALLATION:

- Windshield hinge-mounted, holds four lights
- Prewired, does not require threading wire through tube
- Connects to Mopar Light Installation Kit

- Light Bar includes mounting tabs for two or four lights (lights and in-vehicle wiring sold separately)
- Heavy-duty charging system required when using four lights

NOTE: These products are designed solely to enhance the appearance of the vehicle. Since the safety characteristics are limited, they are not intended to prevent injury or damage in the event of an accident. Check state and local regulations for restrictions on the installation and use of Mopar Sport/Light Bars.

LIGHT BAR, TRUCK



Light Bar (shown on Ram Pickup)

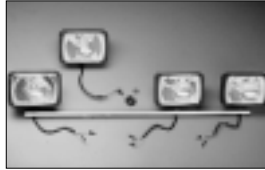

Light Bar Conversion Kit

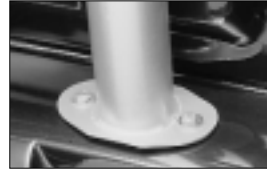

Mounting plate is welded to leg

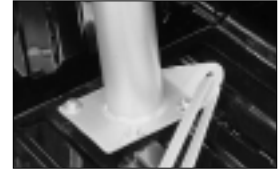

Tie-Down



Includes center-mount stoplight



Accommodates up to four Mopar lights*



Twin tube design

MOPAR FEATURES

- The aluminum version uses an anodizing process that helps to eliminate corrosion, pitting, peeling and is scratch resistant
- Corrosion resistant
- Heavy-duty construction
- The steel version is protected with electrocoat primer and a baked, powdered top coat process, providing a durable finish
- Stainless steel fasteners
- Interior welds provide clean appearance
- Designed specifically to match contours of wheel well and bed
- Stiffener bracket plates mounted under bed sheet metal provide strength and durability, resist movement
- Incorporates center high-mounted stoplight (CHMSL) and cargo lights in the design; Light Bar Conversion Kit available to convert Light Bar to four-light capacity* (lights not included)
- Tie-downs are an integral part of the legs
- Designed by the creators of the Dodge Ram Pickup
- Mandrel bent tubing for a full, smooth appearance
- Mopar Accessories are covered by either the 3-year/36,000-mile New Vehicle Limited Warranty or the 12-month/12,000-mile Mopar Basic Limited Warranty, whichever is more favorable to the customer

COMPETITORS?*

- Is it anodized aluminum? Will it pit or corrode?
- Is it an E-coated paint finish or an enamel finish that may chip, scratch and rust easily?
- Are fasteners plain steel that may rust? Is all hardware stainless steel?
- Does it have unsightly exterior welds?
- Is it a universal fit? Does it project beyond the wheel well?
- Does it shake and rattle?
- Does it block the CHMSL? Does it provide cargo lights?
- Does the design cover the truck tie-downs?
- Is tubing bent without a mandrel, leaving unsightly wrinkles?
- Does the warranty compare?

*Check your market for your competitive situation.

INSTALLATION:

Conversion Kit consists of:

- One-piece crown (front) section with left and right mounting legs

Wiring Kit consists of:

- Switch, underhood and instrument panel wiring, required for complete Off-Road Light installation

NOTE: Heavy-duty charging system required when using four lights. Do not use lights that exceed 55 watts each.

NOTE: This product is designed solely to enhance the appearance of the vehicle. Since the safety characteristics are limited, it is not intended to prevent injury or damage in the event of an accident. Check state and local regulations on installation and use of Off-Road Lights.

NOTE: Off-Road Lights should be added at the time of Light Bar installation. To install lights after installation requires the removal of the Light Bar. Off-Road Lights and Light Bar sold separately.

NOTE: When using the Light Bar Conversion Kit that expands from two to four lights, order two light kits and two installation kits.

LIGHT BAR (CONT.)

Vehicle Line	MYO	MYI	Application Remarks	Part Number	Instl Time	Group	Sugg Retail Price
LIGHT BAR & BED RAIL COMBINATION*							
Dakota Regular & Club Cab	2001	1997	Black Steel, includes bed rails for 6.5 ft. Bed	82202786	1.5	T	630.00
	2001	1997	Black Aluminum, includes bed rails for 6.5 ft. Bed	82202784	1.5	T	660.00
	2001	1997	Silver Aluminum, includes bed rails for 6.5 ft. Bed	82202785	1.5	T	660.00
	2001	1997	Chrome Steel, includes bed rails for 6.5 ft. Bed	82202787	1.5	T	870.00
LIGHT BARS*							
Ram Regular Cab w/6.5' Bed	2001	1994	Black steel, single-tube style, has 2-lamp capacity	82401152	1.5	T	425.00
	2001	1994	Black aluminum, single-tube style, has 2-lamp capacity	82401052	1.5	T	575.00
	2001	1994	Silver aluminum, single-tube style, has 2-lamp capacity	82401051	1.5	T	575.00
Ram Regular Cab w/8.0' Bed	2001	1994	Black steel, single-tube style, has 2-lamp capacity	82401151	1.5	T	445.00
	2001	1994	Black aluminum, single-tube style, has 2-lamp capacity	82401054	1.5	T	595.00
	2001	1994	Silver aluminum, single-tube style, has 2-lamp capacity	82401053	1.5	T	595.00
Wrangler	2001	1997	Black steel, holds up to 4 lights	82203317	0.6	T	185.00
	2001	1997	Black aluminum, holds up to 4 lights	82203320	0.6	T	215.00
	2001	1997	Chrome, holds up to 4 lights	82203322	0.6	T	255.00

*NOTE: These products are designed to enhance the appearance of the vehicle. Since their safety characteristics are limited, they are not intended to prevent injury or damage in the event of an accident. Check state and local restrictions on the installation and use of Mopar Sport/Light Bars.

LIGHTS, FOG



Fog Lights (Dakota, Durango)



Fog Lights (Ram Pickup)



Fog Lights (shown on Grand Cherokee)



Fog Lights shown on PT Cruiser

MOPAR FEATURES	COMPETITORS?*
<ul style="list-style-type: none"> • Original equipment Fog Lights for factory-installed look • “Plug-in” connectors; minimal “cut-and-splice” wiring that could corrode or break over the lifetime of the light • Mopar Fog Lights use OE Wire Connectors on lights and Wire Harness • Wires are enclosed in a convolute sleeve for protection • Wired to operate only with low beam or parking lights • Fog Light beam undercuts inclement weather, minimizes glare • Mopar Fog Lights meet appropriate SAE standards • Tested to ensure no interference with the cooling system operation • OE-style switch with telltale indicator for convenient use • Mopar Accessories are covered by either the 3-year/36,000-mile New Vehicle Limited Warranty or the 12-month/12,000-mile Mopar Basic Limited Warranty, whichever is more favorable to the customer 	<ul style="list-style-type: none"> • Is it a universal fit, which may require splicing using crimp connectors? • Are crimp connectors required for installation, which may cause nicked wires or wire corrosion? Will wires vibrate loose? • Are wires enclosed in convolute sleeves? • Do they operate on high beam, which is illegal in many states? • Do they meet SAE standards? • Will lights block airflow to cooling system? • Does it use a generic switch without a telltale? • Does the warranty compare?

*Check your market for your competitive situation.

INSTALLATION:

- Custom wiring harness mimics OE wiring for color and function
- Complete kit includes lights, wiring, relay, switch and instructions
- Use with low beam or parking lamps only
- Cannot be used with OE Fog Lights

*Check state and local regulations on installation and use of Fog Lights.

LIGHTS, FOG (CONT.)

Vehicle Line	MYO	MYI	Application Remarks	Part Number	Instl Time	Group	Sugg Retail Price
FOG & OFF-ROAD LIGHT LENS COVERS*							
Dakota (All)	2001	1986	Lens Cover for Mopar Round Fog Lights and Off-Road Lights	82204503	D.I.Y.	T	24.00
Ram Pickup (All)	2001	1994	Lens Cover for Mopar Round Fog Lights and Off-Road Lights	82204503	D.I.Y.	T	24.00
Wrangler	2001	1997	Solid-Style, covers lens and features Jeep logo, must be removed during operation of lamp	82202586	D.I.Y.	T	19.00
FOG AND DRIVING LIGHT INSTALLATION KITS*							
Cherokee	2000	1997	Installation package required to mount fog lights with a Mopar Brush Guard	82203280	1.2	T	32.50
	2001	1998	Installation Kit, Fog Lights, includes switch, wiring and relay	82204235	1.2	T	75.00
Wrangler	2001	2000	Fog Light Installation Package, includes lamps	82206505	1.2	T	TBD
	2001	1997	Bracket, to mount Fog Lights on Mopar Tubular Front Bumper	82202610	0.2	T	20.00
	2001	1997	Fog Light Wire Harness	82203245	D.I.Y.	T	29.00
	2001	1997	Installation Kit, includes switch, wiring, and relay, requires lamp	82202394	1.2	T	77.00
FOG LIGHTS FOR MOUNTING ON GRILLE OR BRUSH GUARD*							
Cherokee, Wrangler	2000	1989	5"x7" w/chrome housing, 55-watt, includes impact-resistant covers	82201230	0.2	T	92.50
Dakota (All)	2000	1991	Set of two 2.5 x 5.5 inch rectangular Fog Lights	82400594	0.2	T	98.00
	2000	1989	5"x7" w/black metal housing, 55-watt, includes impact resistant covers	82201229	0.2	T	103.00
FOG LIGHTS — OE STYLE*							
Cherokee	2001	1997	Fog Lights, OE-style, mount in fascia, requires installation Kit	82203403	0.5	T	91.50
Dakota (All)	2000	1999	Complete Kit same as OE Fog Lights; For use on a Dakota that is not equipped with the optional Light Group and on all Durango	82205001	D.I.Y.	T	130.00
	2000	1999	Fog Light Package OE Style, use when equipped w/cargo light	82205659	D.I.Y.	T	130.00
	2000	1999	Fog Light Package, for pick-ups not equipped w/cargo light and Durango	82205658	D.I.Y.	T	130.00
Durango	2000	1999	Complete Kit same as OE Fog Lights; For use on a Dakota that is not equipped with the optional Light Group and on all Durango	82205001	D.I.Y.	T	130.00
	2000	1999	Fog Light Package, for pick-ups not equipped w/cargo light and Durango	82205658	D.I.Y.	T	130.00
Grand Cherokee	2000	1999	Fog Light Package, complete, includes lights, wiring and switch, upgrades vehicle to automatic headlamps	82204837	1.2	T	195.00
Grand Cherokee Laredo	2001	2001	Fog Light Kit, Complete with wiring and switch, upgrades vehicle to automatic headlamps	82206653	1.2	T	195.00
Neon	2000	2000	Complete kit, includes wiring and headlamp switch	82205046	1.0	T	136.00
PT Cruiser	2001	2001	Complete kit, includes wiring and headlamp switch	82205451	1.7	T	104.00
Ram Pickup (All)	2001	1999	Fog Light Package, use when equipped w/cargo light	82205656	1.2	T	169.00
	2001	1999	Fog Light Package, use when not equipped w/cargo light	82205657	1.2	T	169.00
Wrangler	2001	1997	Fog Lights, round OE Lights, requires Installation Kit	82204418	0.2	T	112.00

*NOTE: Check state and local regulations for restrictions on installation and use of Fog Lights and Driving Lights.

LIGHTS, FOG (CONT.)

Vehicle Line	MYO	MYI	Application Remarks	Part Number	Instl Time	Group	Sugg Retail Price
FOG LIGHTS FOR MOUNTING ON GRILLE OR BRUSH GUARD* (CONT.)							
Ram Pickup (All)	2001	1994	5"x7" w/black plastic housing, 55-watt, includes impact-resistant covers	82201228	0.2	T	85.00
	2001	1994	5"x7" w/chrome housing, 55-watt, includes impact-resistant covers	82201230	0.2	T	92.50
	2000	1994	Set of two 2.5 x 5.5 inch rectangular Fog Lights	82400594	0.2	T	98.00
	2000	1994	5"x7" w/black metal housing, 55-watt, includes impact resistant covers	82201229	0.2	T	103.00
	2000	1994	5"x7" w/stainless steel housing, 55-watt, includes impact-resistant covers	82201231	0.2	T	119.00
	2000	1999	Fog Light Package, use when equipped with cargo light	82205661	D.I.Y.	T	175.00
Wrangler	2000	1997	5"x7" w/black plastic housing, 55-watt, includes impact-resistant covers	82201228	0.2	T	85.00
	2000	1997	5"x7" w/black metal housing, 55-watt, includes impact resistant covers	82201229	0.2	T	103.00

LIGHTS, MISCELLANEOUS

Vehicle Line	MYO	MYI	Application Remarks	Part Number	Instl Time	Group	Sugg Retail Price
RELAY — POWER OUTLET FOR KEY-OFF POWER							
Minivan (All)	2000	1996	Allows the cigarette and accessory outlets to be on at all times	82301039	0.1	T	8.00
RUNNING LIGHTS							
Ram Pickup (All)	2001	1998	Roof-Mounted, set of 5 lights, similar to OE	82205120	0.7	T	52.00

*NOTE: Check state and local regulations for restrictions on installation and use of Fog Lights and Driving Lights.

LIGHTS, OFF-ROAD



Off-Road Lights (shown on Wrangler)



Brush-style Cover
PN 82202585



Style matches OE housing
Fog Lights

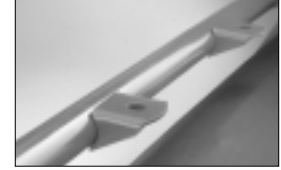

Mopar Light Bar available



PN 82201775



PN 82201776



PN 82201777

MOPAR FEATURES

- Mopar Lights use OE, plug-in wire connectors on lights and wire harnesses
- Wires are enclosed in a convolute sleeve for protection
- OE-style on/off illuminated rocker switch
- Mopar Accessories are covered by either the 3-year/36,000-mile New Vehicle Limited Warranty, or the 12-month/12,000-mile Mopar Basic Limited Warranty, whichever is more favorable to the customer

COMPETITORS?*

- Are crimp connectors required for installation, which may cause nicked wires or wire corrosion?
- Will wires vibrate loose?
- Are wires enclosed in convolute sleeves?
- Is it illuminated, easy to use, integrated in instrument panel?
- Does the warranty compare?

*Check your market for your competitive situation.

INSTALLATION:

- Mopar offers a variety of sizes and styles: 6" round or 5"x7" rectangular
- Packaged in pairs, lens covers included
- Installation Package sold separately for use with 2 or 4 lights
- The Installation Kit, PN 82202526, is used in conjunction with the wiring in the Mopar Light Bar
- Not approved for regular highway use; most states require that lights remain covered when not in off-road use; operate with high beam headlights only

NOTE: When installing four Off-Road Lights, order two sets of lights and two sets of Installation Kits. Heavy-duty charging system required when using four lights. Check local regulations for restrictions on installation and use of Mopar Off-Road Lights.

NOTE: These products are designed to enhance the appearance of the vehicle. Since the safety characteristics are limited, they are not intended to prevent injury or damage in the event of an accident. Check state and local restrictions on the installation and use of Mopar Sport/Light Bars. Wrangler windshield cannot lower with Light Bar installed.

LIGHTS, OFF-ROAD (CONT.)



Off-Road Light 82204005



Off-Road Light 82201777



Off-Road Light 82201778



Off-Road Light 82201775



Off-Road Light 82201776



Off-Road Light 82203691



Off-Road Light 82203692

INSTALLATION:

- Installation package sold separately
- **Note:** When using the Light Bar Conversion Kit to install four Off-Road Lights, if they are more than 55 watts each, order two Installation Kits, heavy-duty charging system required when using four lights.
- Check local regulations for restrictions on installation and use of Mopar Off-Road Lights.

MOPAR FEATURES	COMPETITORS?*
<ul style="list-style-type: none"> • Mopar offers a variety of sizes and styles • Designed to fit Light Bar • Most states require that lights remain covered when not in off-road use (covers included) • Operate with high beam headlamps only • Mopar Lights use OE wire connectors on lights and wire harnesses • Wires are enclosed in a convolute sleeve for protection • Mopar Accessories are covered by either the 3-year/36,000-mile New Vehicle Limited Warranty or the 12-month/12,000-mile Mopar Basic Limited Warranty, whichever is more favorable to the customer 	<ul style="list-style-type: none"> • Are crimp connectors required for installation, which may cause nicked wires or wire corrosion? Will wires vibrate loose? • Are wires enclosed in convolute sleeves? • Does the warranty compare?

*Check your market for your competitive situation.

LIGHTS, OFF-ROAD (CONT.)

Vehicle Line	MYO	MYI	Application Remarks	Part Number	Instl Time	Group	Sugg Retail Price
OFF-ROAD LIGHT INSTALLATION KITS*							
Dakota (All)	2000	1999	Wiring Harness, includes wiring, switch and relays required to install lights on Light Bars	82205343	2.0	T	58.00
Ram Pickup (All)	2001	1994	Black steel, use w/ PN 82401152 and PN 82401151	82401169	0.2	T	36.00
	2001	1994	Black aluminum, use w/ PN 82401052 and PN 82401054	82401181	0.2	T	46.00
	2001	1994	Silver aluminum, use w/ PN 82401051 and PN 82401053	82401182	0.2	T	46.00
	2001	1999	Wiring Harness, includes wiring, switch and relays required to install lights on Light Bars	82205342	2.0	T	106.00
Wrangler	2001	1997	Wiring Harness, includes wiring, switch and relays required to install lights on Light Bars	82202526	2.0	T	50.00
OFF-ROAD LIGHTS*							
Dakota (All)	2001	1989	5"x7" w/black plastic housing, 55-watt, 167,000 candle power	82201252	0.5	T	90.00
	2001	1989	5"x7" w/black metal housing, 55-watt, 90,000 candle power	82201775	0.5	T	102.00
	2001	1989	5"x7" w/chrome metal housing, 55-watt, 90,000 candle power	82201776	0.5	T	115.00
	2001	1989	6.0" round w/chrome metal housing, 55-watt, 125,000 candle power	82201778	0.5	T	120.00
	2001	1986	6.0" round w/black metal housing, 55-watt, 75,000 candle power	82204005	0.5	T	126.00
	2001	1989	6.0" round w/black metal housing, 55-watt, 125,000 candle power	82201777	0.5	T	127.00
	2001	1986	6"x9" w/black metal housing, 55-watt, 125,000 candle power	82203691	0.5	T	136.00
	2001	1986	6"x9" w/chrome metal housing, 55-watt, 125,000 candle power	82203692	0.5	T	140.00
Ram Pickup (All)	2001	1994	5"x7" w/black plastic housing, 55-watt, 167,000 candle power	82201252	0.5	T	90.00
	2001	1994	5"x7" w/black metal housing, 55-watt, 90,000 candle power	82201775	0.5	T	102.00
	2001	1994	5"x7" w/chrome metal housing, 55-watt, 90,000 candle power	82201776	0.5	T	115.00
	2001	1994	6.0" round w/chrome metal housing, 55-watt, 125,000 candle power	82201778	0.5	T	120.00
	2001	1994	6.0" round w/black metal housing, 55-watt, 75,000 candle power	82204005	0.5	T	126.00
	2001	1994	6.0" round w/black metal housing, 55-watt, 125,000 candle power	82201777	0.5	T	127.00
	2001	1994	6"x9" w/black metal housing, 55-watt, 125,000 candle power	82203691	0.5	T	136.00
	2001	1994	6"x9" w/chrome metal housing, 55-watt, 125,000 candle power	82203692	0.5	T	140.00
Wrangler	2001	1997	5"x7" w/black plastic housing, 55-watt, 167,000 candle power	82201252	0.5	T	90.00
	2001	1997	5"x7" w/black metal housing, 55-watt, 90,000 candle power	82201775	0.5	T	102.00
	2001	1997	5"x7" w/chrome metal housing, 55-watt, 90,000 candle power	82201776	0.5	T	115.00
	2001	1997	6.0" round w/chrome metal housing, 55-watt, 125,000 candle power	82201778	0.5	T	120.00
	2001	1997	6.0" round w/black plastic housing, 55-watt, 75,000 candle power, includes Jeep logo lens cover	82202529	0.5	T	126.00
	2001	1997	6.0" round w/black metal housing, 55-watt, 125,000 candle power	82201777	0.5	T	127.00
	2001	1997	6"x9" w/black metal housing, 55-watt, 125,000 candle power	82203691	0.5	T	136.00
	2001	1997	6"x9" w/chrome metal housing, 55-watt, 125,000 candle power	82203692	0.5	T	140.00

*NOTE: These products are designed to enhance the appearance of the vehicle. Since their safety characteristics are limited, they are not intended to prevent injury or damage in the event of an accident. Check state and local restrictions on the installation and use of Mopar Sport/Light Bars.

LIGHTS, TAIL GUARD

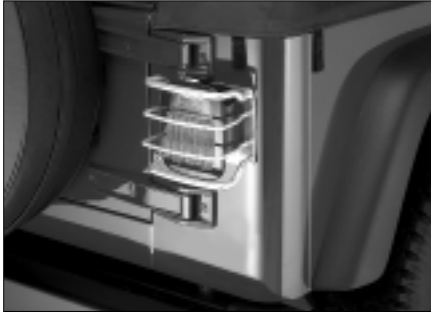

Taillamp Guard (shown on Wrangler)



Mounts directly to body behind taillamp



Meets FMVSS Lighting Standards, does not block lighting pattern

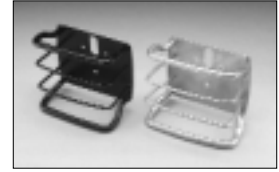

Available in Black or Silver

MOPAR FEATURES	COMPETITORS?*
<ul style="list-style-type: none"> • E-coat primer and powder-coat paint provide a durable finish • Designed specifically to match the contours of Wrangler taillamps • Designed to meet Federal Motor Vehicle Safety Standards lighting requirements • Authentic Jeep® design approved by Jeep Design Team • Mopar Accessories are covered by either the 3-year/36,000-mile New Vehicle Limited Warranty, or the 12-month/12,000-mile Mopar Basic Limited Warranty, whichever is more favorable to the customer 	<ul style="list-style-type: none"> • Does it have an E-coat/powder-coat finish, or an enamel finish, which may chip and scratch easily? • Is it a universal fit? • Is it a hang-on design? • Does it restrict the taillamp lighting visibility? • Mopar Accessories are the only genuine Jeep designed products available for Wrangler • Does the warranty compare?

*Check your market for your competitive situation.

INSTALLATION:

Remove stoplamp, secure guard and replace stoplamp

NOTE: This product is designed solely to enhance the appearance of the vehicle. Since the safety characteristics are limited, it is not intended to prevent injury or damage in the event of an accident. Check state and local regulations on installation and use.

Vehicle Line	MYO	MYI	Application Remarks	Part Number	Instl Time	Group	Sugg Retail Price
GUARDS, TAIL LIGHTS							
Wrangler	2001	1997	Black painted aluminum	82204350	0.2	T	128.00
	2001	1997	Black anodized aluminum	82204349	0.2	T	136.00
	2001	1997	Silver anodized aluminum	82204348	0.2	T	136.00

MASTER SHIELD® PRODUCTS



Master Shield

Vehicle Line	MYO	MYI	Application Remarks	Part Number	Instl Time	Group	Sugg Retail Price
MASTER SHIELD RUST INHIBITOR (WAX BASE)							
All			31-oz bottle, with 1 new vehicle warranty book (MSQ12), limited lifetime warranty	82300506		0	50.00
MASTER SHIELD RUST INHIBITOR (STATE OF WISCONSIN ONLY)							
All			31-oz bottle, with 1 new vehicle 2-year renewable warranty book (MSQ12)	82300512		0	50.00
MASTER SHIELD PAINT SEALANT, ONE-STEP							
All			4-oz bottle (MSQ12), includes 3-year warranty	82300877		0	23.00
			5-gal canister (160 applications), includes 3-year warranty	82203693		0	
MASTER SHIELD FABRIC PROTECTOR							
All			16-oz bottle (MSQ12), includes 3-year warranty	04318045		0	23.00
			5-gal canister (40 applications), includes 3-year warranty	82203694		0	
MASTER SHIELD UNDERCOAT							
All			31-oz bottle (MSQ12)	82300878		0	23.00
MASTER SHIELD APPLICATION EQUIPMENT							
All			Application Gun, Rustproofing Gun	04271236			
			Application Gun, Undercoating Gun	082300887			
			Application Wands, Short	04271237			
			Orbital Polisher For Paint Sealant	04339343			
			Polisher Pads, 10" Pads	04339344			
			Pressurized Spray Applicator, Fabric Protector Sprayer	04339345			
			Rust Inhibitor Package Application Equipment includes Gun, Short Wand, Long Wand	04271235			

MIRRORS, TRAILER TOWING



Trailer Towing Mirror, PN 82401002 (shown on Ram Pickup)



Fold-out Mirror



MOPAR FEATURES	COMPETITORS?*
<ul style="list-style-type: none"> • Help to improve rear visibility when using wide or long trailers, same as OE • 7½" wide x 10½" high mirrors extend 17" from the door • Can be rotated inward to reduce overall vehicle width • Dodge-designed for reduced vibration • Stainless steel hardware, premium quality glass and stainless steel mounts are same as OE • Trim covers holes left from standard mirrors • Mopar Accessories are covered by either the 3-year/36,000-mile New Vehicle Limited Warranty or the 12-month/12,000-mile Mopar Basic Limited Warranty, whichever is more favorable to the customer 	<ul style="list-style-type: none"> • Is it a clamp-on style, which may shake and vibrate? • Is hardware made of plain steel, which may rust? • Is trim cover included? • Does the warranty compare?

*Check your market for your competitive situation.

INSTALLATION:

PN 82401002

- Instructions and hardware included
- Should not be used to replace power mirrors
- Ram Pickup door decal must be removed to install. Order new decal for replacement

PN 82206157

- Instructions and hardware included
- Mirrors replace OE Base Level Mirror. Power control and defrost features deactivate if electric mirrors are removed

Vehicle Line	MYO	MYI	Application Remarks	Part Number	Instl Time	Group	Sugg Retail Price
TRAILER TOWING MIRRORS							
Ram Pickup (All)	2001	1994	7.5" x 10.5", stainless steel (OE-style), left and right, Tripod Style - Door Mounting Ram decal must be moved, also order Ram door applique	82401002	1.7	T	183.00
	2001	1998	7" x 10", OE-style left and right mirrors, OE Window Mount mirrors must be removed, power control and defrost functions deactivated	82206157	1.5	T	270.00

NAVIGATION SYSTEM

This sophisticated, yet simple to use, Navigation System guides you to your precise destination. The new Mopar Navigation System features...



Specialized route calculations

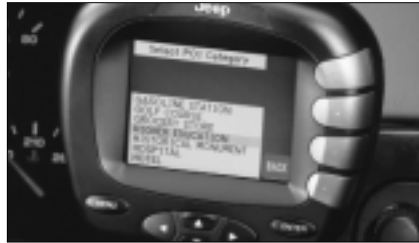

Extensive points of interest listing for quick, easy reference



Easy-to-read turn icons for safer operation



Detailed map screen for quick location orientation



Enhanced intersection view for negotiating complex geography

U.S.A. Coverage Maps



Arizona
Arkansas
California
Colorado
Idaho
Illinois (partial)
Iowa
Kansas
Louisiana
Michigan (partial)
Minnesota
Mississippi
Missouri

Montana
Nebraska
Nevada
North Dakota
Oklahoma
Oregon
South Dakota
Tennessee (partial)
Texas
Utah
Washington
Wisconsin (partial)
Wyoming

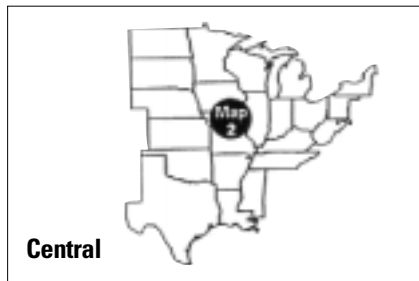

Arkansas
Illinois
Indiana
Iowa
Kansas
Kentucky
Louisiana
Michigan
Minnesota
Mississippi
Missouri
Nebraska

New York (partial)
North Dakota
Ohio
Oklahoma
Pennsylvania (partial)
South Dakota
Tennessee
Texas (partial)
West Virginia
Wisconsin



Alabama
Connecticut
Delaware
District of Columbia
Florida
Georgia
Indiana (partial)
Kentucky
Maine
Maryland
Massachusetts
New Hampshire

New Jersey
New York
North Carolina
Ohio
Pennsylvania
Rhode Island
South Carolina
Tennessee (partial)
Vermont
Virginia
West Virginia
Wisconsin

NAVIGATION SYSTEM (CONT.)

SYSTEM COMPONENTS:

- 3.2" color LCD display module with control switches and speaker for audible directions is mounted left of radio
- Navigation controller which contains GPS receiver, gyroscope, computer board and CD-ROM to accept one of three geographic CDs
- GPS antenna
- One geographic CD

INSTALLATION

- Complete technical support offered at (888) 68-MOPAR
- If navigation controller needs service, order Z5017419AA on Function II for service exchange
- GPS antenna included

MOPAR FEATURES	COMPETITORS?*
<ul style="list-style-type: none"> • Turn-by-turn route guidance with easy-to-read turn icons and voice commands • Destination selection by specific address intersection, freeway entrance/exit, POI, previous destination or personal address book • Easy to use — menu driven with simple controls • Automatic re-routing if turn is missed • Detour function • Only three CDs cover entire United States • Map display • Detailed current location information • Large points-of-interest selections (hotel, restaurant, landmark, etc.) including DaimlerChrysler Motors Corporation dealerships • Mopar Accessories are covered by either the 3-year/36,000-mile New Vehicle Limited Warranty, or the 12-month/12,000-mile Mopar Basic Limited Warranty, whichever is more favorable to the customer 	<ul style="list-style-type: none"> • Does it have easy-to-read turn icons and voice commands? • How many CDs does it use? Most competitors use 7-9 CDs • Does it contain points of interest selections? • Does the warranty compare?

*Check your market for your competitive situation.

NAVIGATION SYSTEM (CONT.)

Vehicle Line	MYO	MYI	Application Remarks	Part Number	Instl Time	Group	Sugg Retail Price
NAVIGATION SYSTEM*							
Durango	2001	2001	Central United States contains complete kit, includes Navigation Display Module, Vehicle Navigation Controller, GPS antenna, wiring harness and one (1) geographic database CD	82206986	1.5		1800.00
	2001	2001	Eastern United States contains complete kit, includes Navigation Display Module, Vehicle Navigation Controller, GPS antenna, wiring harness and one (1) geographic database CD	82206987	1.5		1800.00
	2001	2001	Western United States contains complete kit, includes Navigation Display Module, Vehicle Navigation Controller, GPS antenna, wiring harness and one (1) geographic database CD	82206985	1.5		1800.00
	2001	1999	Navigation System Compact Disc - Additional Geographic CDs - Central	05017416AA	D.I.Y.		150.00
	2001	1999	Navigation System Compact Disc - Additional Geographic CDs - Eastern	05017417AA	D.I.Y.		150.00
	2001	1999	Navigation System Compact Disc - Additional Geographic CDs - Western	05017415AA	D.I.Y.		150.00
Grand Cherokee	2001	1999	Central United States contains complete kit, includes Navigation Display Module, Vehicle Navigation Controller, GPS antenna, wiring harness and one (1) geographic database CD	82205774	1.5		1800.00
	2001	1999	Eastern United States contains complete kit, includes Navigation Display Module, Vehicle Navigation Controller, GPS antenna, wiring harness and one (1) geographic database CD	82205775	1.5		1800.00
	2001	1999	Western United States contains complete kit, includes Navigation Display Module, Vehicle Navigation Controller, GPS antenna, wiring harness and one (1) geographic database CD	82205773	1.5		1800.00
	2001	1999	Navigation System Compact Disc - Additional Geographic CDs - Central	05017416AA	D.I.Y.		150.00
	2001	1999	Navigation System Compact Disc - Additional Geographic CDs - Eastern	05017417AA	D.I.Y.		150.00
	2001	1999	Navigation System Compact Disc - Additional Geographic CDs - Western	05017415AA	D.I.Y.		150.00
Intrepid	2001	2001	Central United States contains complete kit, includes Navigation Display Module, Vehicle Navigation Controller, GPS antenna, wiring harness and one (1) geographic database CD	82206989	1.5		1800.00
	2001	2001	Eastern United States contains complete kit, includes Navigation Display Module, Vehicle Navigation Controller, GPS antenna, wiring harness and one (1) geographic database CD	82206990	1.5		1800.00
	2001	2001	Western United States contains complete kit, includes Navigation Display Module, Vehicle Navigation Controller, GPS antenna, wiring harness and one (1) geographic database CD	82206988	1.5		1800.00
	2001	2001	Navigation System Compact Disc - Additional Geographic CDs - Central	05017416AA	D.I.Y.		150.00
	2001	2001	Navigation System Compact Disc - Additional Geographic CDs - Eastern	05017417AA	D.I.Y.		150.00
	2001	2001	Navigation System Compact Disc - Additional Geographic CDs - Western	05017415AA	D.I.Y.		150.00

*CDs are updated annually. It is recommended that owners update their CD once a year.

NAVIGATION SYSTEM (CONT.)

Vehicle Line	MY0	MY1	Application Remarks	Part Number	Instl Time	Group	Sugg Retail Price
NAVIGATION SYSTEM (CONT.)*							
Minivan (All)	2001	2001	Central United States contains complete kit, includes Navigation Display Module, Vehicle Navigation Controller, GPS antenna, wiring harness and one (1) geographic database CD	82206635	1.5		1800.00
	2001	2001	Eastern United States contains complete kit, includes Navigation Display Module, Vehicle Navigation Controller, GPS antenna, wiring harness and one (1) geographic database CD	82206636	1.5		1800.00
	2001	2001	Western United States contains complete kit, includes Navigation Display Module, Vehicle Navigation Controller, GPS antenna, wiring harness and one (1) geographic database CD	82206634	1.5		1800.00
	2001	2001	Navigation System Compact Disc - Additional Geographic CDs - Central	05017416AA	D.I.Y.		150.00
	2001	2001	Navigation System Compact Disc - Additional Geographic CDs - Eastern	05017417AA	D.I.Y.		150.00
	2001	2001	Navigation System Compact Disc - Additional Geographic CDs - Western	05017415AA	D.I.Y.		150.00
	PT Cruiser	2001	2001	Central U.S.; complete kit; includes Navigation Display Module, Vehicle Navigation Controller, GPS Antenna, wiring harness and 1 geographic database CD	82206321	1.5	
2001		2001	Eastern U.S.; complete kit; includes Navigation Display Module, Vehicle Navigation Controller, GPS Antenna, wiring harness and 1 geographic database CD	82206322	1.5		1800.00
2001		2001	Western U.S.; complete kit; includes Navigation Display Module, Vehicle Navigation Controller, GPS Antenna, wiring harness and 1 geographic database CD	82206320	1.5		1800.00
2001		2001	Navigation System Compact Disc - Additional Geographic CDs - Central	05017416AA	D.I.Y.		150.00
2001		2001	Navigation System Compact Disc - Additional Geographic CDs - Eastern	05017417AA	D.I.Y.		150.00
2001		2001	Navigation System Compact Disc - Additional Geographic CDs - Western	05017415AA	D.I.Y.		150.00

*CDs are updated annually. It is recommended that owners update their CD once a year.

PAINT, TOUCH-UP

EXTERIOR COLORS — 2001 PASSENGER CARS

Paint Code	Sales Code	Color Name	PT Cruiser	Cirrus, Stratus, Breeze	Sebring Conv.	Concorde, Intrepid, LHS, 300M	Neon	Prowler	Viper	MOPAR TOUCH-UP PAINT		Sherwin-Williams Paint
										Brush	Spray	
1-C		Clear Top Coat	X	X	X	X	X	X	X	4443637	4443632	-
1-P		Corrosion Inhibitor	X	X	X	X	X	X	X	82300508	82300068	-
2-P		Primer/Filler	X	X	X	X	X	X	X	4443636	4443633	-
A68	PD4	Ice Silver Met.		X						05016997AA	05016998AA	60180
DX8	PX8	Black Clear Coat	X	X	X	X	X			4342250	4443609	34858
LRN	PRN	Viper Red Clear Coat							X	82400792	82400793	45963
PR4	PR4	Flame Red Clear Coat					X			82400890	82400891	46916
R87	PRB	Indy Red		X						82400762	82400763	46326
SW1	PW1	Stone White C/C	X		X	X	X			4864104	4864105	51539
TTK	PTK	Taupe Frost Met. Clear Coat	X		X					04886267AA	04886268AA	52567
VLB	PLB	Cinnamon Glaze Met. C/C				X	X			05003510AA	05003511AA	54469
VMT	PMT	Deep Cranberry P/C	X							05003508AA	05003509AA	54119
VRD	PRD	Prowler Red C/C						X		05014032AA	05014033AA	55732
VTE	PTE	Champagne Pearl Met.			X	X				05003512AA	05003513AA	55700
VXT	PXT	Prowler Black C/C						X		05014030AA	05014031AA	55734
WB7	PB7	Patriot Blue P/C	X				X			04889407AA	04889408AA	56683
WE5	PE5	Salsa Red P/C					X			04889447AA	04889448AA	56147
WEL	PEL	Inferno Red Tinted P/C	X		X	X				05013697AA	05013698AA	56148/49762
WS2	PS2	Bright Silver Met. C/C	X		X	X	X			04889427AA	04889428AA	56150
WYR*	PYR	Viper Race Yellow							X	04889662AA	05066467AA	61412
XBQ	PBQ	Steel Blue P/C				X				04889415AA	04889416AA	57772
XGR	PGR	Shale Green Met. C/C				X	X			04889429AA	04889430AA	57765
XQW	PQW	Aquamarine Met. C/C	X							04889423AA	04889424AA	57761
XRV	PRV	Dark Garnet Red P/C	X		X	X	X			04889425AA	04889426AA	59308
T67*	PBV	Indigo Blue		X						05066134AA	05066135AA	60613
W69*	PWR	Satin White		X						05066136AA	05066137AA	60614/60615
S40*	PTF	Light Beige		X						05018472AA	05018473AA	61010
G41*	PGM	Deep Evergreen		X						05018474AA	05018475AA	60734
R70*	PR6	Ruby Red		X						05018476AA	05018477AA	60612
YB2*	PB2	Sterling Blue S/G			X					04889584AA	04889585AA	60118
YBW*	PBW	Bridge Water Blue			X	X			X	04889586AA	04889587AA	60119
YSA	PSA	Prowler Silver						X		04889537AA	05017630AA	60129
YVF*	PVF	Prowler Orange						X		04889623AA	05066598AA	60130
YY6*	PY6	Aztec Yellow P/C	X							04889596AA	04889597AA	60146

*New for 2001.

INTERIOR COLORS — 2001 PASSENGER CARS

Interior Code	Color Name	Cirrus, Stratus, Breeze	Sebring Convertible	Concorde, Intrepid, LHS, 300M	Neon	Prowler	PT		Spray Part Number
							Cruiser	Viper	
DX9	Black							X	4504691
FL	Light Pearl Beige						X		
HD5	Quartz			X					4504706
LAZ	Agate	X	X	X		X			82201399
MF1	Light Neutral			X			X		05003525AA
RC3	Mist Gray								4796190
RJJ	Light Silver Fern		X						4796192
RJK	Medium Silver Fern	X	X						4796192

PAINT, TOUCH-UP (CONT.)

INTERIOR COLORS — 2001 PASSENGER CARS (CONT.)

Interior Code	Color Name	Cirrus, Stratus, Breeze	Sebring Convertible	Concorde, Intrepid, LHS,300M	Neon	Prowler	PT Cruiser	Viper	Spray Part Number
RJL	Dark Silver Fern	X	X						4796192
RK4	Medium Camel		X						4864437
RK5	Medium Camel	X	X	X					4864437
TL2	Light Taupe			X					
VK9	Dark Tan	X		X					05003524AA
WL5	Taupe				X				05003521AA
WL8	Dark Taupe				X		X		5010129AA
WUC	Cognac						X		
XDV	Dark Slate Gray		X	X	X				
XL	Light Gray	X							
XT	Beige	X							
XT1	Cream		X						
XT5	Medium Sandstone		X	X					
YPB	Deep Royal Blue		X						

EXTERIOR COLORS — 2001 JEEP.

Paint Code	Sales Code	Color Name	Wrangler	Grand Cherokee	Cherokee	MOPAR TOUCH-UP PAINT		Sherwin-Williams Paint
						Brush	Spray	
1-C		Clear Top Coat	X	X	X	4443637	4443632	-
1-P		Corrosion Inhibitor	X	X	X	82300508	82300068	-
2-P		Primer/Filler	X	X	X	4443636	4443633	-
DX8	PX8	Black Clear Coat	X	X	X	4342250	4443609	34858
PR4	PR4	Flame Red Clear Coat	X	X	X	82400890	82400891	46916
SG8	PG8	Forest Green Pearl Coat	X		X	4798420	4798421	51062
SW1	PW1	Stone White C/C	X	X	X	4864104	4864105	51539
VYH	PYH	Solar Yellow C/C	X			05013705AA	05013706AA	56092
WB7/ WBT	PB7/ PBT	Patriot Blue P/C	X	X	X	04889407AA	04889408AA	56683/56684
WTH	PTH	Champagne P/C		X		05013713AA	05013715AA	57056
WU7	PU7	Sienna P/C	X		X	04889409AA	4889410AA	56368
WUL	PUL	Sienna Tinted P/C		X		05013716AA	05013717AA	56687
XBQ	PBQ	Steel Blue P/C	X	X	X	04889415AA	0489416AA	57772
XGR	PGR	Shale Green Met. C/C		X		04889429AA	04889430AA	57765
XS5	PS5	Silverstone Met. C/C	X	X	X	04889419AA	04889420AA	58314
XV3	PV3	Amber Fire P/C	X			04889411AA	04889412AA	58315
YUB*	PUB	Woodland Brown S/G	X			04889594AA	04889595AA	60196

*New for 2001.

INTERIOR COLORS — 2001 JEEP.

Interior Code	Color Name	Wrangler	Grand Cherokee	Cherokee	Spray Pt. No.
LAZ	Agate	X	X	X	82201399
LG8	Dark Green	X			82201453
RK5	Medium Camel	X	X	X	4864437
WL5	Taupe		X		05003521AA
XT5	Medium Sandstone		X		

PAINT, TOUCH-UP (CONT.)

EXTERIOR COLORS — 2001 CARAVAN, VOYAGER, TOWN & COUNTRY

Paint Code	Sales Code	Color Name	MOPAR TOUCH-UP PAINT		Sherwin-Williams Paint
			Brush	Spray	
1-C		Clear Top Coat	04443637	04443632	—
1-P		Corrosion Inhibitor	82300508	82300068	—
2-P		Primer/Filler	04443636	04443633	—
GW7	PW7	Bright White Clear Coat	04504065	04504066	37298
PR4	PR4	Flame Red Clear Coat	82400890	82400891	46916
SWP	PWP	Golden White Pearl Tri-Coat	04798428	04798429	51074/51075
TTK	PTK	Taupe Frost Metallic Clear Coat	04886267AA	04886268AA	52567
VAW	PAW	Deep Slate P/C	04886273AA	04886274AA	54118
VMT	PMT	Deep Cranberry P/C	05003508AA	05003509AA	54119
VTE	PTE	Champagne Pearl Metallic	05003512AA	05003513AA	55700
WB7	PB7	Patriot Blue P/C	04889407AA	04889408AA	56683
WEL	PEL	Inferno Red Tinted P/C	05013697AA	05013698AA	56148/49762
WG2	PG2	Light Cypress Green P/C	05013699AA	05013700AA	56090
WS2	PS2	Bright Silver Met. C/C	04889427AA	04889428AA	56150
XBQ	PBQ	Steel Blue	04889415AA	04889416AA	57772
XGR	PGR	Shale Green Met. C/C	04889429AA	04889430AA	57765
XQW	PQW	Aquamarine Met. C/C	04889423AA	04889424AA	57761
XRV	PRV	Dark Garnet Red	04889425AA	04889426	59308
YB2	PB2	Sterling Blue	04889584AA	04889587AA	60119

INTERIOR PAINT — 2000 CARAVAN, VOYAGER, TOWN & COUNTRY

Interior Code	Color Name	Spray Pt. No.
RC3	Mist Gray	4796190
RJK	Medium Silver Fern	4796192
RK5	Medium Camel	4864437
QL	Navy Blue	
WL5	Taupe	05003521AA
WL8	Dark Taupe	05010129AA
XTA	Light Sandstone	

PAINT, TOUCH-UP (CONT.)

EXTERIOR COLORS — 2001 TRUCK, VAN AND SPORT-UTILITY

Paint Code	Sales Code	Color Name	AB	AN	BR/BE	DN	MOPAR TOUCH-UP PAINT		Sherwin-Williams Paint
							Brush	Spray	
1-C		Clear Top Coat	X	X	X	X	4443637	4443632	-
1-P		Corrosion Inhibitor	X	X	X	X	82300508	82300068	-
2-P		Primer/Filler	X	X	X	X	4443636	4443633	-
DX8	PX8	Black Clear Coat		X	X	X	4342250	4443609	34858
GW6	PW6	Bright White	X				4504065	4504066	38132
GW7	PW7	Bright White Clear Coat		X	X	X	04889598AA	04889599AA	37298
LE1	PE1	Colorado Red	X				82201354	82201355	36318
LG4	PG4	Hunter Green Metallic	X				82201448	82201449	46580
MR8	PR8	Director Red Metallic	X				82201356	82201357	45861
MS4	PS4	Bright Platinum Met. C/C				X	82300455	82300456	48823
MSC	PSC	Light Arctic Gray	X				82201616	82201617	46958
PR4	PR4	Flame Red Clear Coat		X	X	X	82400890	82400891	46916
SG8	PG8	Forest Green Pearl Coat		X	X	X	4798420	4798421	51062
SPG	PPG	Dark Spruce Metallic	X				4864096	4864097	51530
TX9	PX9	Black	X				2809785	2809784	57879
VB3	PB3	Intense Blue P/C		X	X		005003516AA	005003517AA	54468
VEA	PEA	Chili Pepper Red P/C				X	005003518AA	005003519AA	54470
WB7/ WBT	PB7/ PBT	Patriot Blue P/C		X	X		04889407AA	04889408AA	56683/56684
WS2	PS2	Brt. Silver Met. C/C		X			04884427AA	04884428AA	56150
WSB	PSB	Brt. Silver Met. C/C	X	X			05013709AA	05013710AA	57270
XRV	PRV	Dark Garnet Red P/C		X	X	X	04889425AA	04889426AA	59308
XTL	PTL	Sierra Bronze P/C		X	X	X	04889421AA	04889422AA	57763
XV3	PV3	Amber Fire P/C		X	X		04889411AA	04889412AA	58315
XVL	PVL	Amber Fire P/C		X			04889413AA	04889414AA	57771
YFF*	PFF	Lt. Pewter Met. C/C			X		04889588AA	04889589AA	60116

*New for 2001.

INTERIOR PAINT — 2000 DODGE TRUCK

Interior Code	Color Name						Spray Pt. No.
		Ram Van, Wagon (RWD)	Dakota Pickup	Ram Quad Cab Pickup	Ram Pickup	Durango	
LAZ	Agate		X	X	X	X	82201399
RC3	Mist Gray	X	X	X	X	X	04796190
RC8	Mist Gray	X	X	X	X	X	04796190
RK5	Medium Camel	X		X	X	X	04864437
VK9	Dark Tan	X		X	X	X	05003524AA
XDV	Dark Slate Gray	X	X			X	
XT5	Medium Sandstone	X				X	
WL5	Taupe		X			X	

RACKS & CARRIERS — ADAPTERS

Vehicle Line	MYO	MYI	Application Remarks	Part Number	Instl Time	Group	Sugg Retail Price
CARRIERS-ADAPTERS							
Cherokee, Grand Cherokee, Wrangler	2001	1986	Bike Frame Adapter, adds horizontal crossbar to fit Hitch-Mount Carrier	82202827	D.I.Y.	T	20.00
Durango, Ram Pickup	2001	1986	Bike Frame Adapter, adds horizontal crossbar to fit Hitch-Mount Carrier	82202827	D.I.Y.	T	20.00
Minivan (All)	2001	1986	Bike Frame Adapter, adds horizontal crossbar to fit Hitch-Mount Carrier	82202827	D.I.Y.	T	20.00
Passenger Cars (All)	2001	1986	Bike Frame Adapter, adds horizontal crossbar to fit Hitch-Mount Carrier	82202827	D.I.Y.	T	20.00
Ram Van/Wagon, Dakota (All)	2001	1986	Bike Frame Adapter, adds horizontal crossbar to fit Hitch-Mount Carrier	82202827	D.I.Y.	T	20.00
PT Cruiser	2001	2001	Roof Rack Carrier Adapter Kit - (set of four) required to use Mopar carriers with the OE roof rack	82205847	D.I.Y.	T	20.00

RACKS & CARRIERS — CARRIER, AIRPORTER



Airporter Carriers



Includes wheels for transporting



MOPAR FEATURES

- Polyethylene construction is durable and weather resistant
- Includes wheels for easy transporting
- Able to carry downhill skis, cross country skis, snowboards, fishing poles, skates, hockey sticks, camping gear, golf bags or other equipment
- Mopar Accessories are covered by either the 3-year/36,000-mile New Vehicle Limited Warranty, or the 12-month/12,000-mile Mopar Basic Limited Warranty, whichever is more favorable to the customer

COMPETITORS?*

- Are carriers constructed of a long-lasting material?
- Are wheels included, or will you have to carry the carrier?
- Are carriers too fragile to be checked as luggage?
- Does warranty compare?

*Check your market for your competitive situation.

INSTALLATION:

- Carriers mount easily on OE Roof Rack with Sport-Utility Bars or on Mopar Roof Racks
- No tools required for installation

Vehicle Line	MYO	MYI	Application Remarks	Part Number	Instl Time	Group	Sugg Retail Price
"AIRPORTER" MULTIPURPOSE CARRIER, USE WITH OE ROOF RACK OR MOPAR ROOF RACKS							
Minivan (All)	2001	1996	Black, with handle and wheels, can hold 1 pair of skis or fishing poles, etc.	82204698*	D.I.Y.	T	200.00
	2001	1996	Black, with handle and wheels, can hold 2 pairs of skis or 1 snowboard, fishing poles, etc.	82204699*	D.I.Y.	T	230.00
Cherokee, Grand Cherokee	2001	1999	Black, with handle and wheels, can hold 1 pair of skis or fishing poles, 9¼" x 5½" x 59" closed, extends up to 89"	82204698*	D.I.Y.	T	200.00
	2001	1999	Black, with handle and wheels, can hold 2 pairs of skis or 1 snowboard, 12½" x 6" x 61½" closed, extends up to 67"	82204699*	D.I.Y.	T	230.00
Dakota, Quad Cab, Durango	2001	1998	Black, with handle and wheels, can hold 1 pair of skis or fishing poles, must be used w/Sport-Utility Bars on Durango (PN 82203984), 9¼" x 5½" x 59" closed, extends up to 87"	82204698*	D.I.Y.	T	200.00
	2001	1998	Black, with handle and wheels, can hold 2 pairs of skis or 1 snowboard, must be used w/Sport-Utility Bars on Durango (PN 82203984), 12½" x 6" x 61½" closed, extends up to 67"	82204699*	D.I.Y.	T	230.00
PT Cruiser	2001	2001	Black, with handle and wheels, can hold 1 pair of skis or fishing poles, must be used with OE or Mopar Roof Rack 9¼" x 5½" x 59" closed, extends up to 89"	82204698*	D.I.Y.	T	200.00
	2001	2001	Black, with handle and wheels, can hold 2 pairs of skis or 1 snowboard, must be used with OE or Mopar Roof Rack 12½" x 6" x 61½" closed, extends up to 67"	82204699*	D.I.Y.	T	230.00

*Do not exceed roof capacity of vehicle.

RACKS & CARRIERS — CARRIER, BICYCLE, BED-MOUNT



Bed-Mount Bike Carrier (shown on Ram)



Bed-Mount Strap



Fork-Mount Attachment

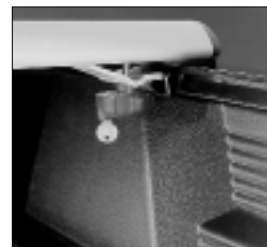

Rack, clamp-on, lockable



Bike Carrier with Multipurpose Removable Rack (shown on Dakota) 82300581



Bed Attachment



Rail Attachment/clamp to vehicle

MOPAR FEATURES

- Designed for Ram Pickup and Dakota
- Aluminum and steel bike carrier system attaches to bed rail with lockable clamps
- Carries up to four bikes in upright position with additional Fork Mounts (optional)
- Optional accessories available to enhance the capabilities of original rack
- Locking carrier and lockable attachments
- Security Kit also available
- Mopar Accessories are covered by either the 3-year/36,000-mile New Vehicle Limited Warranty or the 12-month/12,000-mile Mopar Basic Limited Warranty, whichever is more favorable to the customer

COMPETITORS?*

- Is it a universal fit that extends beyond the bed?
- Is it lockable?
- Does the warranty compare?

*Check your market for your competitive situation.

INSTALLATION:

- Easy to install
- Installs in minutes
- Holds up to 3 Bike Carriers

RACKS & CARRIERS — CARRIER, BICYCLE, BED-MOUNT (CONT.)

Vehicle Line	MYO	MYI	Application Remarks	Part Number	Instl Time	Group	Sugg Retail Price
CARRIERS — BICYCLE, BED-MOUNT							
Dakota (All)	2001	1987	Bicycle Carrier - Truck Bed Mounted, Optional Security Kit	82203192	D.I.Y.	T	20.00
	2001	1987	Bicycle Carrier - Truck Bed Mounted, Optional Wheel holder, mounts front wheel to rack	82203191	D.I.Y.	T	37.00
	2001	1987	Additional fork-mount adapters,required to carry more than 2 bikes	82203193	D.I.Y.	T	43.00
	2001	1997	Fork-Mount Bicycle Carrier - Truck Bed Mounted, Holds Two Bikes	82203189	D.I.Y.	T	110.00
	2001	1994	Bicycle Carrier - Bed Mounted, Holds 1 Bike Upright mount,	82300581	D.I.Y.	T	115.00
Ram Pickup - Regular Cab (All)	2001	1994	Bicycle Carrier - Truck Bed Mounted, Optional Security Kit	82203192	D.I.Y.	T	20.00
	2001	1984	Bicycle Carrier - Truck Bed Mounted, Optional Wheel holder, mounts front wheel to rack	82203191	D.I.Y.	T	37.00
	2001	1994	Additional fork-mount adapters,required to carry more than 2 bikes	82203193	D.I.Y.	T	43.00
	2001	1994	Fork-Mount Bicycle Carrier - Truck Bed Mounted, Holds Two Bikes	82203190	D.I.Y.	T	86.00
	2001	1994	Bicycle Carrier - Bed Mounted, Holds 1 Bike Upright mount	82300581	D.I.Y.	T	115.00

RACKS & CARRIERS — CARRIER, BICYCLE, HITCH-MOUNT



Hitch Receiver with Fold-Down Bike Carrier (shown on Durango)



Shown in fold-down position (shown on Stratus)



Bike Carrier Kit



Carrier in the down position



Carrier in fold-down position

MOPAR FEATURES

- Carries up to four bikes (with horizontal crossbars)
- Carrier mounts quickly on a hitch receiver
- Adapter adds horizontal crossbar to bikes without them (a Mopar exclusive)
- Fold-down feature allows liftgate to be opened without removing bikes
- Proving-Grounds tested for durability
- Foot-operated tilt lever
- Foam inserts added to lockable clamps help protect bike finish and provide added security
- E-coated paint finish helps prevent rust
- Theft-resistant lock pin
- Mopar Accessories are covered by either the 3-year/36,000-mile New Vehicle Limited Warranty or the 12-month/12,000-mile Mopar Basic Limited Warranty, whichever is more favorable to the customer

COMPETITORS?*

- Does their carrier tilt down with little effort, or do you have to remove it for tailgate access?
- Are carriers tested? How?
- Does lever require you to crouch down or lift up and operate a dirty mechanism by hand?
- Does carrier lock bikes for security? Will clamps scratch bike finish?
- Is it E-coated? Will it rust?
- Does the warranty compare?

*Check your market for your competitive situation.

INSTALLATION:

- Easy to install
- Requires hand tools
- Requires Hitch Receiver
- Security Allen wrench included

RACKS & CARRIERS — CARRIER, BICYCLE, HITCH-MOUNT (CONT.)

Vehicle Line	MYO	MYI	Application Remarks	Part Number	Instl Time	Group	Sugg Retail Price
CARRIERS — BICYCLE, HITCH-MOUNT							
Breeze, Cirrus, Stratus, Sebring Sedan & Conv., Stratus Sedan, Intrepid, 300M, Neon, Prowler	2001	1993	Hitch-Mount Bike Carrier, use w/1.25-Inch Hitch Receiver, Holds 2 bikes with crossbars, fold-down style	82204452	D.I.Y.	T	200.00
Cherokee, Grand Cherokee	2001	1991	Hitch-Mount Bike Carrier, use w/2.0-Inch Hitch Receiver, holds 2 bikes with crossbars, fold-down style	82204453	D.I.Y.	T	205.00
	2001	1984	Hitch-Mount Bike Carrier, use w/ 2.0-Inch Hitch Receiver, Holds 4 bikes with crossbars, fold-down style	82204328	D.I.Y.	T	255.00
Durango	2001	1998	Hitch-Mount Bike Carrier, use w/2.0-Inch Hitch Receiver, holds 2 bikes with crossbars, fold-down style	82204453	D.I.Y.	T	205.00
	2001	1998	Hitch-Mount Bike Carrier, use w/ 2.0-Inch Hitch Receiver, Holds 4 bikes with crossbars, fold-down style	82204328	D.I.Y.	T	255.00
Minivan	2001	1996	Hitch-Mount Bike Carrier, use w/1.25-Inch Hitch Receiver, Holds 2 bikes with crossbars, fold-down style	82204452	D.I.Y.	T	200.00
	2001	1996	Hitch-Mount Bike Carrier, use w/2.0-Inch Hitch Receiver, holds 2 bikes with crossbars, fold-down style	82204453	D.I.Y.	T	205.00
	2001	1996	Hitch-Mount Bike Carrier, use w/ 2.0-Inch Hitch Receiver, Holds 4 bikes with crossbars, fold-down style	82204328	D.I.Y.	T	255.00
PT Cruiser	2001	2001	Hitch-Mount Bike Carrier, use w/1.25-Inch Hitch Receiver, Holds 2 bikes with crossbars, fold-down style	82204452	D.I.Y.	T	200.00
Wrangler	2001	1997	Hitch-Mount Bike Carrier, use w/1.25-Inch Hitch Receiver, Holds 2 bikes with crossbars, fold-down style	82204452	D.I.Y.	T	200.00

RACKS & CARRIERS — CARRIER, BICYCLE, INTERIOR-MOUNT



Minivan

MOPAR FEATURES	COMPETITORS?*
<ul style="list-style-type: none"> • Attaches easily to seat floor mounting point • Heavy-duty all steel carrier holds two bikes • Two carriers can be used per vehicle to hold a total of four bikes • Mopar Accessories are covered by either the 3-year/36,000-mile New Vehicle Limited Warranty, or the 12-month/12,000-mile Mopar Basic Limited Warranty, whichever is more favorable to the customer 	<ul style="list-style-type: none"> • Is it easily attachable? • Is it made of steel? • Can it hold a total of four bikes? • Does the warranty compare?

*Check your market for your competitive situation.

Vehicle Line	MYO	MYI	Application Remarks	Part Number	Instl Time	Group	Sugg Retail Price
CARRIERS — BICYCLE, INTERIOR-MOUNT							
Minivan (All)	2000	1996	Bicycle Carrier - Interior Mounted Holds 2 bikes, mounts to floor in rear	82205107	0.2	T	230.00
Ram Wagon	2001	1971	Bicycle Carrier - Interior Mounted Holds 2 bikes, mounts to floor in rear	82205107	0.2	T	230.00

RACKS & CARRIERS — CARRIER, BICYCLE, ROOF-MOUNT



Bike Carrier



Bike Carrier (shown on Grand Cherokee)



Upright Style



Sport-Utility Bar Attachment



Fork Attachment



Rear-Wheel Attachment

MOPAR FEATURES

- Fork-Mount style includes front-wheel carrier
- Upright style secures bikes without removing wheels
- Carrier and components are specially painted and UV-coated for long-lasting protection
- Carrier clamps are foam inserted to protect bike surface
- Proving-Grounds tested for stability and durability
- Carriers are designed to provide a tight, vibration-free fit
- Mopar Accessories are covered by either the 3-year/36,000-mile New Vehicle Limited Warranty or the 12-month/12,000-mile Mopar Basic Limited Warranty, whichever is more favorable to the customer

COMPETITORS?*

- Are their attachments specially painted and UV-coated?
- Are clamps foam inserted? Or will clamps cause the bike surface to be scratched?
- Have they been tested? Will they shake or vibrate? Are they resistant to crosswinds?
- Do carriers fit tightly? Will they experience road vibration?
- Does the warranty compare?

*Check your market for your competitive situation.

INSTALLATION:

- Easy to install
- Requires hand tools
- Carriers are fully assembled

RACKS & CARRIERS — CARRIER, BICYCLE, ROOF-MOUNT (CONT.)

Vehicle Line	MYO	MYI	Application Remarks	Part Number	Instl Time	Group	Sugg Retail Price
CARRIERS — BICYCLE, ROOF-MOUNT							
Breeze, Cirrus, Stratus, Sebring Sedan, Stratus Sedan, Concorde, Intrepid, LHS, 300M, Neon, PT Cruiser	2001	1993	Bicycle Carrier - Roof Mounted - Fork-Mounted, w/front wheel holder, must use with Sport-Utility Bars or Mopar removable Roof Rack	82300585**	D.I.Y.	T	105.00
	2001	1993	Bicycle Carrier - Roof Mounted, - Upright Style Upright mount, must be used Sport-Utility Bars or Mopar removable Roof Rack	82203471**	D.I.Y.	T	125.00
Cherokee, Grand Cherokee	2001	1986	Bicycle Carrier - Roof Mounted - Fork-Mounted, w/front wheel holder, must use with Sport-Utility Bars or Mopar removable Roof Rack	82300585	D.I.Y.	T	105.00
	2001	1984	Bicycle Carrier - Roof Mounted, - Upright Style Upright mount, must be used Sport-Utility Bars or Mopar removable Roof Rack	82203471 [†]	D.I.Y.	T	125.00
Dakota Quad Cab	2001	1986	Bicycle Carrier - Roof Mounted - Fork-Mounted, w/front wheel holder, must use with Sport-Utility Bars or Mopar removable Roof Rack	82300585	D.I.Y.	T	105.00
	2001	2000	Bicycle Carrier - Roof Mounted, - Upright Style Upright mount, must be used Sport-Utility Bars or Mopar removable Roof Rack	82203471 ^{††§}	D.I.Y.	T	125.00
Durango	2001	1998	Bicycle Carrier - Roof Mounted - Fork-Mounted, w/front wheel holder, must use with Sport-Utility Bars or Mopar removable Roof Rack	82300585	D.I.Y.	T	105.00
	2001	1998	Bicycle Carrier - Roof Mounted, - Upright Style Upright mount, must be used Sport-Utility Bars or Mopar removable Roof Rack	82203471 ^{††}	D.I.Y.	T	125.00
Minivan (All)	2001	1996	Bicycle Carrier - Roof Mounted - Fork-Mounted, w/front wheel holder, must use with Sport-Utility Bars or Mopar removable Roof Rack	82300585 [†]	D.I.Y.	T	105.00
	2001	1996	Bicycle Carrier - Roof Mounted, - Upright Style Upright mount, must be used Sport-Utility Bars or Mopar removable Roof Rack	82203471 [†]	D.I.Y.	T	125.00

*When used with PT Cruiser OE Roof Rack, Adapter Kit 82205847 required.

[†] Two (2) carriers can be used per roof rack.

^{††} Not for off-road use.

[§] Dakota Quad Cab™ does not have an OE Roof Rack, must order 82204961 also.

RACKS & CARRIERS — CARRIER, BICYCLE, SPARE TIRE-MOUNT



Spare Tire Bike Carrier (shown on Wrangler)



Mounting Plate

MOPAR FEATURES	COMPETITORS?*
<ul style="list-style-type: none"> • Steel construction, E-coat/powder-coat finish • Tubular design • Holds two bikes (with horizontal-style top tubes) • Adapter available for bikes without horizontal top tubes • Spare tire carrier supports tire, wheel, bike carrier and bikes up to a maximum of 75 lbs • Foam inserts added to lockable clamps help protect bike finish and provide added security • Tested for durability • Triple locking; cable, tabs and your lock secure bike to Bike Carrier • Spare tire lock nut secures Bike Carrier to vehicle • Carrier mounts to the spare tire • Does not harm the spare tire • Mopar Accessories are covered by either the 3-year/36,000-mile New Vehicle Limited Warranty, or the 12-month/12,000-mile Mopar Basic Limited Warranty, whichever is more favorable to the customer 	<ul style="list-style-type: none"> • Does it have an E-coat/powder-coat finish? Will it rust? • Does carrier lock bikes for security? • Will clamps scratch bike crosstubes? • Are theirs proving grounds-tested for durability? • Does the carrier lock to the vehicle? • Does carrier clamp to spare tire, possibly chafing tire over time? • Does the warranty compare?

*Check your market for your competitive situation.

INSTALLATION:

- Installs or removes in minutes
- Owners simply slide rack onto the mounting plate and install one bolt
- Bolt has a tab with an opening that allows the rack to be locked to the mounting plate; bikes can be locked to the rack using included cable
- For loading bike, T-handle at the top of the rack is merely loosened, not removed, to move clamping plate

Vehicle Line	MYO MYI	Application Remarks	Part Number	Instl Time	Group	Sugg Retail Price
CARRIERS — BICYCLE, SPARE TIRE-MOUNT						
Wrangler	2001 1997	Bicycle Carrier - Spare Tire Mounted, Holds 2 Bikes w/crossbars	82201480*	D.I.Y.	T	199.00

*Not for use with 30"x9½" tires.

RACKS & CARRIERS — CARRIER, CANOE



Canoe Carrier

MOPAR FEATURES	COMPETITORS?*
<ul style="list-style-type: none"> • Carrier is fully adjustable and mounts easily on Sport-Utility Bars • Carrier and components are specially painted and UV-coated for long-lasting protection • Pushbutton ratchet strap system provides for easy removal and attachment • Holds one canoe securely • Tested for stability and durability on several hull designs • Carriers are designed to provide a tight, vibration-free fit • Mopar Accessories are covered by either the 3-year/36,000-mile New Vehicle Limited Warranty, or the 12-month/12,000-mile Mopar Basic Limited Warranty, whichever is more favorable to the customer 	<ul style="list-style-type: none"> • Are their attachments specially painted and UV-coated? • Does it use cheaper, hard-to-use “thread through” straps? • Has it been tested? Will it shake or vibrate? How many hull designs will fit it? • Do carriers fit tightly? Will they experience road vibration? • Does the warranty compare?

*Check your market for your competitive situation.

INSTALLATION:

- Easy to install
- Hand tools required

Vehicle Line	MYO MYI	Application Remarks	Part Number	Instl Time	Group	Sugg Retail Price
CARRIERS — CANOE*						
Cherokee, Grand Cherokee	2001 1991	Canoe Carrier, must be used w/Sport-Utility Bars or Mopar Roof Rack	82204700	D.I.Y.	T	107.00
Durango	2001 1998	Canoe Carrier, must be used w/Sport-Utility Bars or Mopar Roof Rack	82204700	D.I.Y.	T	107.00
Minivan (All)	2001 1996	Canoe Carrier, must be used w/Sport-Utility Bars or Mopar Roof Rack	82204700	D.I.Y.	T	107.00

*Do not exceed roof capacity of vehicle.

RACKS & CARRIERS — CARRIER, COMMERCIAL EQUIPMENT, RAM RACK



MOPAR FEATURES

- The ultimate sliding rack system for trucks
- The racks slide and are removable. Racks and accessories can be repositioned or removed in seconds
- Racks and cargo holder can be adjusted to secure any cargo. Tie downs adjust with a twist
- Easily installed. No drilling or damage — Ram Trac Rac compression mounts onto the side rails for a safe and secure fit
- Built of tough anodized aluminum, it is 100 percent rust and corrosion free
- A variety of accessories allows the system to be used for both work and play
- Mopar Accessories are covered by either the 3-year/36,000-mile New Vehicle Limited Warranty, or the 12-month/12,000-mile Mopar Basic Limited Warranty, whichever is more favorable to the customer

COMPETITORS?*

- Does the rack slide or is it bolted in place?
- Does the installation require drilling, bolting, or other way of damaging the truck?
- Is the rack a flexible system or just a rack locked into one position?
- Will it rust or corrode?
- Does it allow for customization?
- Does the warranty compare?

*Check your market for your competitive situation.

Vehicle Line	MY0	MY1	Application Remarks	Part Number	Instl Time	Group	Sugg Retail Price
CARRIERS — COMMERCIAL EQUIPMENT — RAM RACK							
Ram Pickup w/6.5' Bed	2001	1994	Rail Kit, requires Rack Kit PN 82204854	82204856	1.0		420.00
	2001	1994	Ladder Rack Kit, requires Rail Kit	82204854	D.I.Y.		410.00
	2001	1994	Lock Kit - Rail - 2 locking knobs	82205239	D.I.Y.		49.00
	2001	1994	Tool Box Mounting Kit - allows Mopar tool box to be mounted to Ram Rack	82205240	D.I.Y.		81.00
	2001	1994	Divider Kit- Cargo Bed, top mounted sliding cargo holder	82205238	D.I.Y.		275.00
	2001	1994	Brake Light Kit - Roof Mount (to be used with Ram Rack)	82206778	0.5		129.00
	2001	2001	Movable Tie-Down for Ram Rack Kit, set of 2	82205237	D.I.Y.		49.00
Ram Pickup w/8.0 Ft. Bed	2001	1994	Rail Kit, requires Rack Kit PN 82204854	82204855	1.0		420.00

RACKS & CARRIERS — CARRIER, LUGGAGE



Weather-resistant vinyl, aerodynamic Luggage Carrier mounted on OE Roof Rack (shown on Grand Cherokee)



Collapsible

MOPAR FEATURES	COMPETITORS?*
<ul style="list-style-type: none"> • Mounts easily to OE Roof Rack • Fits between side rails and crossbars • Coated nylon material with sealed seams and a protective flap is weather-resistant • Folds up easily for storage • Custom-fit sewn-in tie-down straps, will not get lost, custom fit to roof rack • Carriers are designed to provide a tight, vibration-free fit • Zippered opening with protective, secured flaps for weather resistance • Mopar Accessories are covered by either the 3-year/36,000-mile New Vehicle Limited Warranty or the 12-month/12,000-mile Mopar Basic Limited Warranty, whichever is more favorable to the customer 	<ul style="list-style-type: none"> • Does it fit securely between the side rails and crossbars? • Is the cover weatherproof? • Is it a bulky, hard shell that is hard to store? • Are eyelets, tie-down loops or bungee straps used? • Do carriers fit tightly? Will they experience road vibration? • Does the warranty compare?

*Check your market for your competitive situation.

INSTALLATION:

- Installs in minutes
- Attaches to OE Roof Rack
- Dimensions: 36" x 46" x 15,"
11.2 cubic feet

Vehicle Line	MYO	MYI	Application Remarks	Part Number	Instl Time	Group	Sugg Retail Price
CARRIERS — LUGGAGE							
Cherokee, Grand Cherokee	2001	1991	7900	Weatherproof Luggage Carrier, Black nylon, 11.2 cubic feet (36"x46"x15")	82204344**†	D.I.Y.	T 113.00
Durango	2001	1998	7900	Weatherproof Luggage Carrier, Black nylon, 11.2 cubic feet (36"x46"x15")	82204344**†	D.I.Y.	T 113.00
Minivan (All)	2001	1996	7900	Weatherproof Luggage Carrier, Black nylon, 11.2 cubic feet (36"x46"x15")	82204344**†	D.I.Y.	T 113.00

**Do not exceed roof capacity of vehicle. Not for vehicles with sunroof.

†Luggage carriers are not water resistant.

RACKS & CARRIERS — CARRIER, ROOF BASKET



Roof Basket Carrier (shown on Durango)



Roof Basket Carrier (shown on Grand Cherokee)

MOPAR FEATURES	COMPETITORS?*
<ul style="list-style-type: none"> Carrier and components are specially painted and UV-coated for long-lasting protection Large size accommodates bulky or oversized luggage and equipment; adds to cargo area Dimensions are 36"x46" Accommodates available Weatherproof Luggage Carrier Proving-Grounds tested for stability and durability Carriers are designed to provide a tight, vibration-free fit; easily installed on the Sport-Utility Bars; includes webbed netting for security Mopar Accessories are covered by either the 3-year/36,000-mile New Vehicle Limited Warranty or the 12-month/12,000-mile Mopar Basic Limited Warranty, whichever is more favorable to the customer 	<ul style="list-style-type: none"> Are their attachments specially painted and UV-coated? Do the measurements compare? Can bulky or oversized items be carried safely? Has it been tested? Will it shake or vibrate? Do carriers fit tightly? Will they experience road vibration? Does the warranty compare?

*Check your market for your competitive situation.

INSTALLATION:

- Easy to install
- Hand tools required

Vehicle Line	MYO	MYI	Application Remarks	Part Number	Instl Time	Group	Sugg Retail Price
BASKET CARRIER							
Minivan (All)	2001	1996	Roof Basket Carrier, Black, must be used w/Sport-Utility Bars	82204697*	D.I.Y.	T	250.00
	2001	1996	Web Net, designed to be used with Basket Carrier, Black (36"x46")	82204857	D.I.Y.	T	53.00
BASKET CARRIER, USE WITH SPORT-UTILITY BARS							
Cherokee, Grand Cherokee	2001	1991	Black, must be used w/Sport-Utility Bars	82204697*	D.I.Y.	T	250.00
	2001	1999	Web Net, designed for use w/Basket Carrier (Black 36"x46")	82204857	D.I.Y.	T	53.00
Durango	2000	1998	Black, must be used w/Sport-Utility Bars (PN 82203984)*	82204697*	D.I.Y.	T	250.00
	2000	1998	Web Net, designed to be used w/Basket Carrier, Black (36"x46")	82204857	D.I.Y.	T	53.00

*Do not exceed roof capacity of vehicle.

RACKS & CARRIERS — CARRIERS, SKI & SNOWBOARD, BED-MOUNT



Horizontal Ski Carrier with multipurpose removable rack (shown on Ram Pickup), 82300589

MOPAR FEATURES	COMPETITORS?*
<ul style="list-style-type: none"> • Two sizes available: two pairs of skis or one snowboard; four pairs of skis or two snowboards • Horizontal Ski Carriers have hidden attachments for security • Built-in locks for added security • Made of corrosion-resistant materials to help prevent corrosion and for durability • Carriers are designed to provide a tight, vibration-free fit • Mopar Accessories are covered by either the 3-year/36,000-mile New Vehicle Limited Warranty or the 12-month/12,000-mile Mopar Basic Limited Warranty, whichever is more favorable to the customer 	<ul style="list-style-type: none"> • Does it have exposed attachments which require hand tools to install? Can it be easily stolen? • Is it a universal fit? • Does it have installed locks or an option for locks? • Is it made of unprotected steel, which may rust? • Do carriers fit tightly? Will they experience road vibration? • Does the warranty compare?

*Check your market for your competitive situation.

INSTALLATION:

- Ski and Snowboard Carriers use the Multipurpose Bed Mount Rack for installation
- Install without tools
- Easily assembled

INSTALLATION TIME:

Do it yourself

Vehicle Line	MYO MYI	Application Remarks	Part Number	Instl Time	Group	Sugg Retail Price
CARRIERS — SKI & SNOWBOARD, BED-MOUNT						
Dakota (All)	2001 1988	Ski Carrier - Bed Mounted, 4 Pairs - Use with Bed Mount Rack	82300589	D.I.Y.		50.00
Ram Pickup - Regular Cab (All)	2001 1994	Ski Carrier - Bed Mounted, 4 Pairs - Use with Bed Mount Rack	82300589	D.I.Y.		50.00

RACKS & CARRIERS — CARRIER, SKI, HITCH-MOUNT

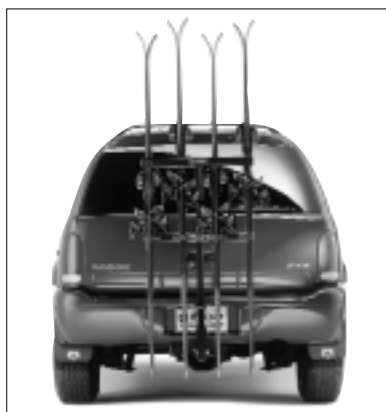

Hitch-Mount Ski Carrier (shown on Durango)



Fixed-style Ski Carrier Kit, hitch-mount

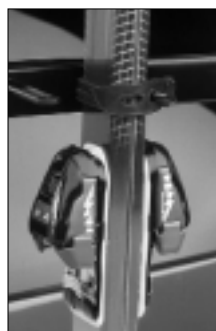

Skis held securely in place

MOPAR FEATURES	COMPETITORS?*
<ul style="list-style-type: none"> • Carries up to four pairs of skis • Proving-Grounds tested for durability • Operates easily with foot-operated lever • E-coated paint finish helps prevent rust • Mopar Accessories are covered by either the 3-year/36,000-mile New Vehicle Limited Warranty, or the 12-month/12,000-mile Mopar Basic Limited Warranty, whichever is more favorable to the customer 	<ul style="list-style-type: none"> • Has it been tested for durability? How? • Is it E-coated? Will it rust?

*Check your market for your competitive situation.

INSTALLATION:

- Requires hand tools and antitheft Allen wrench (included)
- Requires receiver-style hitch

Vehicle Line	MYO	MYI	Application Remarks	Part Number	Instl Time	Group	Sugg Retail Price
CARRIERS — SKI & SNOWBOARD, HITCH-MOUNT							
Breeze, Cirrus, Stratus, Sebring Sedan, Sebring Convertible, Concorde, Intrepid, LHS, 300M, Neon, Prowler	2001	1993	Ski Carrier - Hitch Mounted, Holds 4 Pairs, fold-down style - Use with 1.25" Hitch Receiver	82204454	D.I.Y.	T	220.00
Cherokee	2001	1991	Ski Carrier - Hitch Mounted, Holds 4 Pairs, fold-down style - Use with 1.25" Hitch Receiver	82204454	D.I.Y.	T	220.00
	2001	1991	Ski Carrier - Hitch Mounted, Holds 4 Pairs, fold-down style - Use with 2" Hitch Receiver	82204455	D.I.Y.	T	235.00
Durango	2001	1998	Ski Carrier - Hitch Mounted, Holds 4 Pairs, fold-down style - Use with 1.25" Hitch Receiver	82204454	D.I.Y.	T	220.00
	2001	1998	Ski Carrier - Hitch Mounted, Holds 4 Pairs, fold-down style - Use with 2" Hitch Receiver	82204455	D.I.Y.	T	235.00
Grand Cherokee	2001	1999	Ski Carrier - Hitch Mounted, Holds 4 Pairs, fold-down style - Use with 2" Hitch Receiver	82204455	D.I.Y.	T	235.00
Minivan (All)	2001	1996	Ski Carrier - Hitch Mounted, Holds 4 Pairs, fold-down style - Use with 1.25" Hitch Receiver	82204454	D.I.Y.	T	220.00
	2001	2001	Ski Carrier - Hitch Mounted, Holds 4 Pairs, fold-down style - Use with 2" Hitch Receiver	82204455	D.I.Y.	T	235.00

RACKS & CARRIERS — CARRIER, SKI & SNOWBOARD, ROOF-MOUNT



OE Roof Rack with Horizontal Ski Carriers



Modular High-Mount Ski Carrier open, showing locking mechanisms



Horizontal Ski and Snowboard Carrier (shown on PT Cruiser)



6-Pair Ski Carrier — New Silver Style



2 styles of Horizontal Carriers (2 or 4 pairs)

MOPAR FEATURES

- Holds up to six pairs of skis or four snowboards ... or a combination of both (depending on carrier)
- Opens on both sides for easy loading and unloading
- Integrated locks with corrosion-resistant covers help secure those winter toys
- No additional adapters needed
- Mopar Accessories are covered by either the 3-year/36,000-mile New Vehicle Limited Warranty, or the 12-month/12,000-mile Mopar Basic Limited Warranty, whichever is more favorable to the customer

COMPETITORS?*

- Does it have exposed attachments which require ordinary hand tools to install?
- Can it be easily stolen?
- Is it a universal fit?
- Does it fit OE Roof Rack?
- Does it have installed locks or an option for locks?
- Is it made of steel, which may rust?
- Does the warranty compare?

*Check your market for your competitive situation.

INSTALLATION:

- Ski Carriers require OE Roof Rack
- Easily assembled

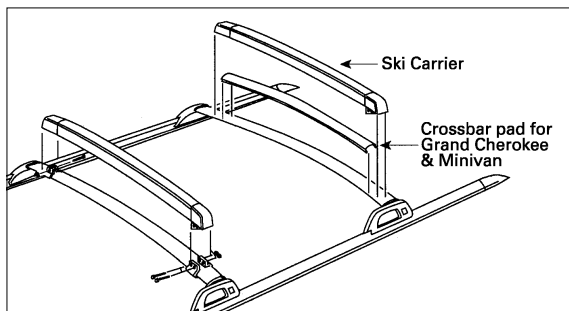
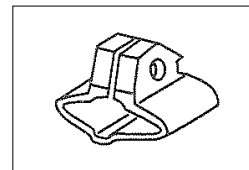

Illustration of brackets and crossbar pads



Adapter

RACKS & CARRIERS — CARRIER, SKI & SNOWBOARD, ROOF-MOUNT (CONT.)

Vehicle Line	MY0	MY1	Application Remarks	Part Number	Instl Time	Group	Sugg Retail Price
CARRIERS — SKI & SNOWBOARD, ROOF-MOUNT							
Breeze, Cirrus, Concorde, Intrepid, LHS, Neon, PT Cruiser, Stratus, 300M	2001	1993	Ski Carrier - Roof Mount, Modular High-Mount style holds 2 pairs of skis, 9.0" long with 6.5" ski opening - Use with Mopar Roof Rack or Sport Utility Bars	82203474*	D.I.Y.	T	50.00
	2001	1993	Ski Carrier - Roof Mount, Horizontal, Aluminum, holds 6 pairs of skis or 4 snowboards, includes adapter kit	82205994	D.I.Y.	T	135.00
Breeze, Cirrus, Concorde, Intrepid, LHS, Neon, PT Cruiser, Sebring Sedan, Stratus, Stratus Sedan, 300M	2001	1993	Ski Carrier - Roof Mount, Modular Scissor-Style holds 2 pairs of skis, 16" long with 13" ski opening - Use with Mopar Roof Rack or Sport Utility Bars	82203472*	D.I.Y.	T	93.00
	2001	1993	Ski Carrier - Roof Mount, Horizontal, Aluminum, holds 6 pairs of skis or 4 snowboards, includes adapter kit	82205994	D.I.Y.	T	135.00
Cherokee, Grand Cherokee	2001	1984	Ski Carrier - Roof Mount, Modular High-Mount style holds 2 pairs of skis, 9.0" long with 6.5" ski opening - Use with Mopar Roof Rack or Sport Utility Bars	82203474*	D.I.Y.	T	50.00
	2001	1984	Ski Carrier - Roof Mount, Modular Scissor-Style holds 2 pairs of skis, 16" long with 13" ski opening - Use with Mopar Roof Rack or Sport Utility Bars	82203472*	D.I.Y.	T	93.00
	2001	1991	Ski Carrier - Roof Mounted, Horizontal holds 4 Pair of Skis or 2 snowboards, 34" long with 28.5" ski opening - Use with OE Roof Rack	82204101	D.I.Y.	T	121.00
	2001	1993	Ski Carrier - Roof Mount, Horizontal, Aluminum, holds 6 pairs of skis or 4 snowboards, includes adapter kit	82205994	D.I.Y.	T	135.00
Dakota Quad Cab	2001	2000	Ski Carrier - Roof Mount, Modular High-Mount style holds 2 pairs of skis, 9.0" long with 6.5" ski opening - Use with Mopar Roof Rack or Sport Utility Bars	82203474	D.I.Y.	T	50.00
	2001	2000	Ski Carrier - Roof Mount, Modular Scissor-Style holds 2 pairs of skis, 16" long with 13" ski opening - Use with Mopar Roof Rack or Sport Utility Bars	82203472	D.I.Y.	T	93.00
	2001	1993	Ski Carrier - Roof Mount, Horizontal, Aluminum, holds 6 pairs of skis or 4 snowboards, includes adapter kit	82205994	D.I.Y.	T	135.00
Durango	2001	1998	Ski Carrier - Roof Mount, Modular High-Mount style holds 2 pairs of skis, 9.0" long with 6.5" ski opening - Use with Mopar Roof Rack or Sport Utility Bars	82203474	D.I.Y.	T	50.00
	2001	1998	Ski Carrier - Roof Mount, Modular Scissor-Style holds 2 pairs of skis, 16" long with 13" ski opening - Use with Mopar Roof Rack or Sport Utility Bars	82203472	D.I.Y.	T	93.00
	2001	1998	Ski Carrier - Roof Mounted, Horizontal holds 4 Pair of Skis or 2 snowboards, 34" long with 28.5" ski opening - Use with OE Roof Rack	82204101	D.I.Y.	T	121.00
	2001	1993	Ski Carrier - Roof Mount, Horizontal, Aluminum, holds 6 pairs of skis or 4 snowboards, includes adapter kit	82205994	D.I.Y.	T	135.00

*Two (2) carriers can be used per roof rack.

RACKS & CARRIERS — CARRIER, SKI & SNOWBOARD, ROOF-MOUNT (CONT.)

Vehicle Line	MYO	MYI	Application Remarks	Part Number	Instl Time	Group	Sugg Retail Price
CARRIERS — SKI & SNOWBOARD, ROOF-MOUNT (CONT.)							
Minivan (All)	2000	1996	Ski Carrier - Roof Mount, Modular High-Mount style, holds 2 pairs of skis, 9.0" long with 6.5" ski opening, use w/Mopar Roof Rack or Sport Utility Bars	82203474*	D.I.Y.	T	50.00
	2000	1996	Ski Carrier - Roof Mount, Modular Scissor-Style, holds 2 pairs of skis, 16" long with 13" ski opening, use w/Mopar Roof Rack or Sport Utility Bars	82203472*	D.I.Y.	T	93.00
	2001	1996	Ski Carrier - Roof Mount, Horizontal, holds 4 Pair of Skis or 2 snowboards, 34" long with 28.5" ski opening, use w/OE Roof Rack	82204101	D.I.Y.	T	121.00
	2001	1993	Ski Carrier - Roof Mount, Horizontal, Aluminum, holds 6 pairs of skis or 4 snowboards, includes adapter kit	82205994	D.I.Y.	T	135.00
PT Cruiser	2001	2001	Ski Carrier - Roof Mount, Horizontal, holds 2 pairs or 1 snowboard, use w/Mopar Roof Rack	82300542*	D.I.Y.	T	78.50
	2001	1993	Ski Carrier - Roof Mount, Horizontal, Aluminum, holds 6 pairs of skis or 4 snowboards, includes adapter kit	82205994	D.I.Y.	T	135.00

*Two (2) carriers can be used per roof rack.

RACKS & CARRIERS — CARRIER, SKI, SPARE TIRE-MOUNT



Spare Tire Ski Carrier (shown on Wrangler)



Mounting plate

MOPAR FEATURES

- Steel construction, E-coat/powder-coat finish
- Tubular design
- Plastic is reinforced, high-strength material
- Holds up to four pairs of skis
- Tested for durability
- Cable included for securing and locking (with your padlock)
- Triple locking — cable, tabs, and your lock secure skis to Ski Carrier
- Spare Tire lock nut secures Ski Carrier to vehicle
- Carrier mounts to the tire carrier, does not harm the spare tire
- Mopar Accessories are covered by either the 3-year/36,000-mile New Vehicle Limited Warranty or the 12-month/12,000-mile Mopar Basic Limited Warranty, whichever is more favorable to the customer

COMPETITORS?*

- Does it have an E-coat/powder-coat finish?
- Has it been tested for durability?
- Can the skis be secured?
- Does the carrier lock to the vehicle?
- Does the carrier clamp to spare tire, possibly chafing tire over time?
- Does the warranty compare?

*Check your market for your competitive situation.

INSTALLATION:

- Designed to be installed on Jeep® Wrangler full-size Spare Tire Carrier (30 x 9.5 R15LT maximum)
- Simply slide rack onto the mounting plate and install one bolt
- Rack can be locked to the mounting plate with spare tire lock nut; the skis can be locked to the rack using the cable included (lock not included)

Vehicle Line	MYO	MYI	Application Remarks	Part Number	Instl Time	Group	Sugg Retail Price
CARRIERS — SKI & SNOWBOARD, SPARE TIRE-MOUNT							
Wrangler	2001	1997	Ski Carrier, Spare Tire Mount, holds 4 pairs, locking	82201359	D.I.Y.	T	170.00

RACKS & CARRIERS — CARRIER, WATER SPORTS



Water Sports Carrier with surfboard
(shown on PT Cruiser)



Water Sports Carrier with kayak
(shown on Grand Cherokee)

MOPAR FEATURES	COMPETITORS?*
<ul style="list-style-type: none"> Carrier and components are specially painted and UV-coated for long-lasting protection Carries sailboards, kayaks or surfboards Latching system features nylon straps that are easily operated with push button Designed to fit several hulls — flat or curved Tested for stability and durability Road- and load-tested for stability and different hull designs Mopar Accessories are covered by either the 3-year/36,000-mile New Vehicle Limited Warranty, or the 12-month/12,000-mile Mopar Basic Limited Warranty, whichever is more favorable to the customer 	<ul style="list-style-type: none"> Are their attachments specially painted and UV-coated? Can it carry more than one water sport item? Can it accommodate both flat and curved hulls? Has it been tested? Will it shake or vibrate? Does the warranty compare?

*Check your market for your competitive situation.

INSTALLATION:

Attaches easily to Mopar Removable
Roof Rack or Sport-Utility Bars

Vehicle Line	MYO	MYI	Application Remarks	Part Number	Instl Time	Group	Sugg Retail Price
CARRIERS — WATERSPORTS EQUIPMENT*							
Cherokee, Grand Cherokee	2001	1991	Water Sport Carrier (kayak, surfboards or sailboards), must be used with Sport-Utility Bars or Mopar Roof Rack	82204701	D.I.Y.	T	143.00
Durango	2001	1998	Water Sport Carrier (kayak, surfboards or sailboards), must be used with Sport-Utility Bars or Mopar Roof Rack	82204701	D.I.Y.	T	143.00
Minivan (All)	2001	1996	Water Sport Carrier (kayak, surfboards or sailboards), must be used with Sport-Utility Bars or Mopar Roof Rack	82204701	D.I.Y.	T	143.00
PT Cruiser	2001	2001	Water Sport Carrier (kayak, surfboards or sailboards), must be used with Sport-Utility Bars or Mopar Roof Rack	82204701	D.I.Y.	T	143.00

*Do not exceed roof capacity of vehicle.

RACKS & CARRIERS — LUGGAGE RACK, HITCH-MOUNT



Prowler



PT Cruiser

MOPAR FEATURES

- Contoured and designed exclusively for each vehicle
- Provides a custom, stylish look
- Black and Gray finish (Prowler only) meets OE paint standards
- Roll formed metal parts are E-coated and powder-coated for durability
- Chrome plated in accordance with strict DaimlerChrysler standards, the Luggage Rack must pass a CASS test to help ensure freedom from cracked plate, loss of Chromium and corrosion status
- Mopar Accessories are covered by either the 3-year/36,000-mile New Vehicle Limited Warranty, or the 12-month/12,000-mile Mopar Basic Limited Warranty, whichever is more favorable to the customer

COMPETITORS?*

- Are they a universal fit application?
- Are the paint finishes tested to OE quality standards?
- Is competition's deck lid rack attached with sheet metal screws that may strip or cause rust?
- Does the rack block CHMSL? Does it meet federal safety standards?
- Do you have to measure various distances from openings and seams?
- Does the warranty compare?

*Check your market for your competitive situation.
Riv-Nut is a registered trademark of B.F. Goodrich.

Vehicle Line	MYO	MYI	Application Remarks	Part Number	Instl Time	Group	Sugg Retail Price
LUGGAGE RACKS — HITCH MOUNTED							
Prowler	2001	1998	Argent, holds up to 100 lbs	82203351	D.I.Y.	T	525.00
PT Cruiser	2001	2001	Chrome plated, holds up to 75 lbs	82205889	D.I.Y.	T	490.00

RACKS & CARRIERS — LUGGAGE RACK, ROOF-MOUNT



OE Permanent-Mount Style Roof Rack (shown on Cherokee)



Roof-Mount Luggage Rack (shown on Dakota Quad Cab™)



Roof-Mount Luggage Rack (shown on Durango)



Removable Roof Rack (shown on Sebring)

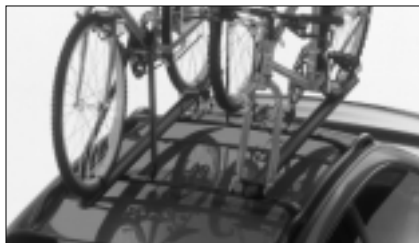

Permanent Roof Rack (shown on Neon)



Upright and Fork Mount Bike Carriers (shown on Concorde)



Ski and Snowboard Carriers



Airporter Carriers (shown on PT Cruiser)



Original Equipment Roof Rack



Crossbar End Cap for Original Equipment Roof Rack

MOPAR FEATURES

- Custom designed to fit and complement the design and style of the roof and vehicle
- Engineered and tested to OE standards
- DaimlerChrysler-engineered and proving grounds-tested for noise and durability
- DaimlerChrysler-approved materials, paints and attachment hardware for durability
- Hidden fasteners don't detract from stylish appearance
- Mopar Accessories are covered by either the 3-year/36,000-mile New Vehicle Limited Warranty, or the 12-month/12,000-mile Mopar Basic Limited Warranty, whichever is more favorable to the customer

COMPETITORS?*

- Is it a universal fit?
- Has it been engineered and tested for performance on Cherokee?
- Does it meet OE standards?
- Does it use sheet metal screws, which may be stripped or cause rust?
- Does the warranty compare?

*Check your market for your competitive situation.

RACKS & CARRIERS — LUGGAGE RACK, ROOF-MOUNT (CONT.)

Vehicle Line	MYO	MYI	Application Remarks	Part Number	Instl Time	Group	Sugg Retail Price
LUGGAGE RACKS — ROOF MOUNTED*							
Avenger, Sebring Coupe	2000	1995	Black,removable, installation tools included	82301034	D.I.Y.	T	190.00
Breeze, Cirrus, Stratus	2000	1995	Black, removable, installation tools included	82301031	D.I.Y.	T	179.00
Cherokee	2001	1999	Black, permanently mounted	82206323	1.5	T	177.00
Concorde, Intrepid, LHS	2001	1998	Black, removable, installation tools included	82203650	D.I.Y.	T	157.00
Dakota Quad Cab	2001	2000	Black, permanently mounted	82204961	1.0	T	200.00
Durango	2001	1998	Black, OE Cross Rails, Sport models	82205928	D.I.Y.	T	115.00
Minivan	2001	2001	Roof rack, permanently mounted, OE style, Long Wheel base only	82206655	1.8	T	179.00
	2001	2001	Roof rack, permanently mounted, OE style, Short Wheel base only	82206656	1.8	T	179.00
Minivan (LWB Only)	2000	1996	Roof rack, permanently mounted, OE style, Long Wheel base only	82300984	1.8	T	160.00
Minivan (SWB Only)	2000	1996	Roof rack, permanently mounted, OE style, Short Wheel base only	82300983	1.8	T	160.00
Neon	2001	2000	Black, removable, installation tools included	82204798	D.I.Y.	T	157.00
PT Cruiser	2001	2001	Silver, removable, installation tools included	82205334	D.I.Y.	T	157.00
Stratus/Sebring Sedan	2001	2001	Silver, removable, installation tools included	82206522	D.I.Y.	T	157.00

*Do not exceed roof capacity of vehicle.

RACKS & CARRIERS — LUGGAGE RACK, SPORT-UTILITY BARS

MOPAR FEATURES	COMPETITORS?*
<ul style="list-style-type: none"> • Required to install various Mopar carriers • Designed for Jeep® vehicles and Mopar • Mopar Accessories are covered by either the 3-year/36,000-mile New Vehicle Limited Warranty, or the 12-month/12,000-mile Mopar Basic Limited Warranty, whichever is more favorable to the customer 	<ul style="list-style-type: none"> • Is it a universal fit? • Does the warranty compare?

*Check your market for your competitive situation.

Vehicle Line	MYO	MYI	Application Remarks	Part Number	Instl Time	Group	Sugg Retail Price
LUGGAGE RACKS — SPORT-UTILITY BARS*							
Cherokee	2001	1991	Mounts to OE Roof Rack	82203447	D.I.Y.	T	100.00
Durango	2001	1998	Mounts to OE Roof Rack	82203984	D.I.Y.	T	130.00
Grand Cherokee	2001	1999	Mounts to OE Roof Rack	82204497	D.I.Y.	T	100.00
Minivan (All)	2000	1996	Mounts to OE Roof Rack	82203592	D.I.Y.	T	100.00
	2001	2001	Mounts to OE Roof Rack	82206609	D.I.Y.	T	150.00

*Do not exceed roof capacity of vehicle.

REAR SEAT VIDEO™



Rear Seat Video™



Rear Seat Video™ Video Cassette Player

MOPAR FEATURES

- This fun and versatile entertainment system plays VHS tapes and features an overhead 6.4-inch active-matrix liquid crystal display (LCD) screen that provides superior picture quality
- The Video Cassette Player (VCP) is housed inside a specially designed floor console
- Overhead monitor mounting is more soothing to watch than low-mount systems
- The console is color keyed to your minivan's interior and can be mounted between the front seats or between the second row quad seats (LWB only)
- Audio can be accessed through the vehicle's sound system and/or through wireless headphones, which can be used in any rear seat
- An auxiliary input is provided for a video camera, CD player, and popular home video game players
- An infrared remote control and two sets of wireless headphones are included with the Rear Seat Video™
- Mopar Accessories are covered by either the 3-year/36,000-mile New Vehicle Limited Warranty, or the 12-month/12,000-mile Mopar Basic Limited Warranty, whichever is more favorable to the customer

COMPETITORS?*

- Does it have a smaller, harder-to-see screen?
- Do components meet automotive specifications for extreme temperatures and vibrations?
- Is the screen mounted overhead or in a floor console?
- Is it color-keyed to match your interior?
- Are the headphones wireless for easy use?
- Is there an auxiliary input?
- Does the warranty compare?

*Check your market for your competitive situation.

INSTALLATION AND SERVICE:

- Complete technical support offered at (888) 68-MOPAR
- If VCR needs service, place exchange order for Z5017498AA
- If overhead screen needs service, place exchange order for Z5017497AA
- All other service parts available in catalog

REAR SEAT VIDEO™ (CONT.)

Vehicle Line	MYO	MYI	Application Remarks	Part Number	Instl Time	Group	Sugg Retail Price
MEDIA SYSTEMS							
Minivan (All)	2000	1998	Rear Seat Video™ (Camel Interior) overhead entertainment system includes a 6.4 inch headliner mounted Active Matrix LCD screen and a video cassette player, includes one wireless headphone	82205682	2.0	KOA	1350.00
	2000	1998	Rear Seat Video™ (Mist Gray Interior) overhead entertainment system includes a 6.4 inch headliner mounted Active Matrix LCD screen and a video cassette player, includes one wireless headphone	82205235	2.0	KOA	1350.00
	2000	1998	Rear Seat Video™ (Silver Fern Interior) overhead entertainment system includes a 6.4 inch headliner mounted Active Matrix LCD screen and a video cassette player, includes one wireless headphone	82205681	2.0	KOA	1350.00
	2000	1998	Rear Seat Video™ (Taupe Interior) overhead entertainment system includes a 6.4 inch headliner mounted Active Matrix LCD screen and a video cassette player, includes one wireless headphone	82205683	2.0	KOA	1350.00
	2001	2001	Rear Seat Video™ (Navy Blue Interior) overhead entertainment system includes a 6.4 inch headliner mounted Active Matrix LCD screen and a video cassette player, includes two wireless headphones	82206270*	2.0		1400.00
	2001	2001	Rear Seat Video™ (Sandstone Interior) overhead entertainment system includes a 6.4 inch headliner mounted Active Matrix LCD screen and a video cassette player, includes two wireless headphones	82206269*	2.0		1400.00
	2001	2001	Rear Seat Video™ (Taupe Interior) overhead entertainment system includes a 6.4 inch headliner mounted Active Matrix LCD screen and a video cassette player, includes two wireless headphones	82206268*	2.0		1400.00
	2001	1998	Additional headphones	05017501AA			42.00

*If a vehicle is not equipped with a Center OE console, also order Console Base Kits; 82206260 Navy Blue, 82206261 Sandstone, 82206262 Taupe.

ROCK RAILS



Rock Rail (shown on Grand Cherokee)



Rock Rail (shown on Wrangler)



Rocker Panel Guard (shown on Wrangler)

MOPAR FEATURES	COMPETITORS?*
<ul style="list-style-type: none"> • Heavy-gauge steel provides for durable, long-lasting protection • Provides lower body-side panel protection from rocks in off-road situations • Available in powder-coated steel • Authentic Jeep® design approved by Jeep Design Team • Mopar Accessories are covered by either the 3-year/36,000-mile New Vehicle Limited Warranty, or the 12-month/12,000-mile Mopar Basic Limited Warranty, whichever is more favorable to the customer 	<ul style="list-style-type: none"> • Is it a less durable gauge steel? • Jeep vehicle-designed products are exclusive to Mopar • Does the warranty compare?

*Check your market for your competitive situation.

INSTALLATION:

- Attach to vehicle substructure
- Rock Rails include necessary hardware for easier mounting
- Some drilling required

Vehicle Line	MYO	MYI	Application Remarks	Part Number	Instl Time	Group	Sugg Retail Price
ROCK RAILS							
Cherokee	2001	1997	Black steel	82205091	1.0	T	335.00
Grand Cherokee	2001	1999	Black steel, for Laredo	82204660	1.0	T	335.00
	2001	1999	Black steel, for Limited	82204661	1.0	T	335.00
Wrangler	2001	2001	Black steel, cannot be used w/front Molded Splash Guards or OE Side Steps	82206457	1.0	T	325.00
	2000	1997	Black steel	82204729*	1.5	T	325.00
ROCKER PANEL GUARDS							
Wrangler - Sport & SE	2001	1997	Rocker Panel Guards, set of four heavy-duty steel treadplates	82204733	0.5	T	176.00

*OEM style Side Steps must be removed.

RUNNING BOARDS, ALUMINUM, JEEP®



Cherokee front and rear end caps



Cherokee all mounting hardware; ready to install

MOPAR FEATURES

- Kits include all hardware and dedicated mounting brackets specifically designed for each model
- The aluminum is anodized to help eliminate corrosion, pitting, peeling, scratches and minimize road debris
- Hidden nut fasteners are serrated, plated and flanged to resist vibration and rust
- E-coated steel support brackets and cadmium-plated fasteners meet DaimlerChrysler's 250-hour salt-spray test; resists corrosion
- Designed with unique black vinyl rub strip
- Support brackets are designed to minimize installation time
- Brackets are designed to meet federal fuel system integrity standards for side impact
- Skid-resistant strips provide added traction
- Mopar Accessories are covered by either the 3-year/36,000-mile New Vehicle Limited Warranty, or the 12-month/12,000-mile Mopar Basic Limited Warranty, whichever is more favorable to the customer

COMPETITORS?*

- Are all materials for installation included?
- Is it anodized aluminum?
- Will it pit, corrode or scratch easily?
- Are the fasteners plain steel, which may rust?
- Does vibration loosen fasteners?
- Are the brackets enamel-painted?
- Are end caps included in the price or are they an additional purchase?
- Is the bracket system an "erector set," i.e., a lot of holes for multiple applications?
- Are federal fuel system integrity standards met?
- Is a skid-resistant surface provided?
- Does the warranty compare?

*Check your market for your competitive situation.

Vehicle Line	MYO	MYI	Application Remarks	Part Number	Instl Time	Group	Sugg Retail Price
RUNNING BOARDS, ALUMINUM — CHEROKEE							
Cherokee	2001	1997	Black	82203401	1.5	T	285.00
	2001	1997	Bright Aluminum	82203400	1.5	T	285.00

RUNNING BOARDS, MOLDED, JEEP®



Molded Running Board, lighted style (Grand Cherokee)



Molded Running Boards (Grand Cherokee)



Molded Running Board (Cherokee)



Molded Splash Guard (Cherokee)



Cherokee Splash Guards, includes front and rear molded



Includes all mounting hardware

MOPAR FEATURES

- The stepping surface is constructed of slip-resistant Santoprene® over a strong, steel substructure
- E-coated steel support brackets and fasteners are designed to meet DaimlerChrysler's 250-hour salt-spray test
- Brackets are designed to meet Federal Motor Vehicle Safety Standards (FMVSS) and fuel system integrity standards for side impact
- Support brackets are designed to minimize installation time
- Designed by DaimlerChrysler's Jeep Design Team for an integrated appearance
- Meet or exceed DaimlerChrysler's standards for chipping, cracking and fade resistance
- Mopar Accessories are covered by either the 3-year/36,000-mile New Vehicle Limited Warranty, or the 12-month/12,000-mile Mopar Basic Limited Warranty, whichever is more favorable to the customer

COMPETITORS?*

- Will the brackets and fasteners pass a 250-hour salt-spray test?
- Will the running boards meet FMVSS fuel system integrity standards?
- Only genuine Jeep Accessories are designed by Jeep Design Team
- Does the warranty compare?

Vehicle Line	MYO	MYI	Application Remarks	Part Number	Instl Time	Group	Sugg Retail Price
RUNNING BOARDS, MOLDED — CHEROKEE							
Cherokee	2000	2000	Fern Green (PJP)	82205764	1.5	T	460.00
	2001	2000	Sienna (PU7)	82205766	1.5	T	480.00
	2001	1997	Black (PX8)	82202702	1.5	T	480.00
	2001	1997	Black Low GLoss, matches SE/Sport Trim	82202701	1.5	T	480.00
	2000	1997	Desert Sand (PTD)	82204904	1.5	T	480.00
	2001	1997	Flame Red (PR4)	82202703	1.5	T	480.00
	2001	1997	Forest Green (PG8)	82204906	1.5	T	480.00
	2001	2000	Patriot Blue (PBT)	82205765	1.5	T	480.00
	2001	2000	Silverstone (PS5)	82205767	1.5	T	480.00
	2001	1997	Stone White (PW1)	82202706	1.5	T	480.00

RUNNING BOARDS & SIDE STEPS — RUNNING BOARDS, MOLDED, JEEP® (CONT.)

Vehicle Line	MY0	MY1	Application Remarks	Part Number	Instl Time	Group	Sugg Retail Price
RUNNING BOARDS, MOLDED — GRAND CHEROKEE*							
Grand Cherokee	2001	1999	Running Board Kit, requires Cladding listed below	82204577	1.0	T	250.00
Grand Cherokee Laredo	2001	2001	Dark Garnet Red (YR8), Cladding w/o Lighting	82206710	0.5	T	183.00
	2001	2000	Dark Gray (K4A) Cladding w/o Lighting	82205219	0.5	T	183.00
	2001	2001	Dark Metallic Blue (YBM), Cladding w/o Lighting	82206709	0.5	T	183.00
	2001	1999	Driftwood (K4K) Cladding w/o Lighting	82204485	0.5	T	183.00
	2001	2001	Dark Garnet Red (YR8), Cladding w/Lighting for Laredo	82206713	1.5	T	310.00
	2001	2000	Dark Gray (K4A) Cladding w/Lighting	82205933	1.5	T	310.00
	2001	2001	Dark Metallic Blue (YBM), Cladding w/Lighting for Laredo	82206712	1.5	T	310.00
	2001	1999	Driftwood Lighted Cladding Kit for Limited	82205932	1.5	T	310.00
Grand Cherokee Limited	2000	1999	Deep Slate (PAW) Cladding w/o Lighting	82204480	0.5	T	240.00
	2000	1999	Everglade (PPT) Cladding w/o Lighting	82204477	0.5	T	240.00
	2001	2001	Steel Blue (QBQ), Cladding w/o Lighting	82206547	0.5	T	240.00
	2000	1999	Taupe Frost (PTK) Cladding w/o Lighting	82204475	0.5	T	240.00
	2001	2001	Woodland Brown, (QUB), Cladding w/o Lighting	82206548	0.5	T	240.00
	2001	1999	Black (PX8) Cladding w/o Lighting	82204481	0.5	T	250.00
	2001	1999	Champagne (PTH) Cladding w/o Lighting	82204476	0.5	T	250.00
	2001	1999	Flame Red (PR4) Cladding w/o Lighting	82204474	0.5	T	250.00
	2001	1999	Patriot Blue (PB7) Cladding w/o Lighting	82204478	0.5	T	250.00
	2001	2000	Shale Green (PGR)- Cladding w/o Lighting	82205723	0.5	T	250.00
	2001	1999	Sienna (PUL) Cladding w/o Lighting	82204473	0.5	T	250.00
	2001	1999	Stone White (PW1) Cladding w/o Lighting	82204482	0.5	T	250.00
	2000	1999	Deep Slate (PAW) Cladding w/Lighting	82204849	1.5	T	380.00
	2000	1999	Everglade (PTK), Cladding w/Lighting	82205720	1.5	T	380.00
	2000	1999	Taupe Frost (PPT), Cladding w/Lighting	82205718	1.5	T	380.00
	2001	2001	Sienna (QBQ) Cladding w/Lighting	82206549	1.5	T	380.00
	2001	2001	Woodland Brown (QUB), Cladding w/Lighting	82206550	1.5	T	380.00
	2001	1999	Black (PX8) Cladding w/Lighting	82205930	1.5	T	390.00
	2001	1999	Champagne (PTH), Cladding w/Lighting	82205719	1.5	T	390.00
	2001	1999	Flame Red (PR4), Cladding w/Lighting	82205717	1.5	T	390.00
	2001	1999	Sienna (PUL), Cladding w/Lighting	82205716	1.5	T	390.00
	2001	1999	Patriot Blue (PB7) Cladding w/Lighting	82205721	1.5	T	390.00
	2001	2000	Shale Green (PGR) Cladding w/Lighting	82205934	1.5	T	390.00
	2001	2000	Silverstone (PS5) Cladding w/Lighting	82205935	1.5	T	390.00
	2001	1999	Stone White (PW1) Cladding w/Lighting	82205931	1.5	T	390.00

*NOTE: Grand Cherokee Running Boards require ordering running board kit and cladding separately.

RUNNING BOARDS, ALUMINUM, MINIVAN

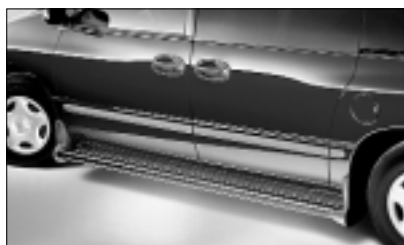

Minivan Aluminum Running Board with Aluminum End Guards

MOPAR FEATURES	COMPETITORS?*
<ul style="list-style-type: none"> • Provide easier vehicle entry and exit • The aluminum is anodized to help eliminate corrosion, pitting and scratches • Nut fasteners are serrated, plated and flanged to resist vibration and rust • E-coated steel support brackets and zinc dichromate fasteners meet DaimlerChrysler Corporation's 250-hour salt-spray test, resist corrosion • Include front and rear matching end guards • Support brackets are designed to minimize installation time • Brackets are designed and impact-tested to meet DaimlerChrysler Corporation's fuel system integrity standards for side impact • Skid-resistant strips provide added traction • Mopar Accessories are covered by either the 3-year/36,000-mile New Vehicle Limited Warranty, or the 12-month/12,000-mile Mopar Basic Limited Warranty, whichever is more favorable to the customer 	<ul style="list-style-type: none"> • Is it anodized aluminum? • Will it pit, corrode, or scratch easily? • Are the fasteners made of plain steel, which may rust? • Does vibration loosen fasteners? • Are the brackets enamel painted? • Are end caps included in the price or are they an additional purchase? • Is the bracket system an "erector set," i.e., a lot of adjustments for multiple applications? • Are fuel system integrity standards met? • Have brackets been impact-tested? • Is a skid-resistant surface provided? • Does the warranty compare?

*Check your market for your competitive situation.

Vehicle Line	MYO	MYI	Application Remarks	Part Number	Instl Time	Group	Sugg Retail Price
RUNNING BOARDS, ALUMINUM							
Minivan (LWB Only)	2000	1996	LWB, aluminum w/aluminum Splash Guards	82203562	1.0	T	245.00
	2000	1996	LWB, aluminum w/molded rubber guards	82203564	1.0	T	300.00
Minivan (SWB Only)	2000	1996	SWB, Aluminum w/Aluminum Splash Guards	82203561	1.0	T	235.00
	2000	1996	SWB, aluminum w/molded rubber guards	82203563	1.0	T	285.00

RUNNING BOARDS, PREMIUM MOLDED, MINIVAN



Molded Running Board (shown on Voyager)

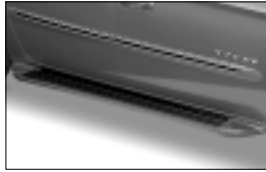

Molded Running Board (shown on Caravan)



Easy-to-install bracket system



Prepainted to match body color on ES, LXi and trim color on LE

MOPAR FEATURES

- Color styles match 10 body colors or four accent colors
- Premium Santoprene® cladding with custom-designed end caps are made of strong TPO plastic to withstand elements and minor impacts, complement vehicle cladding
- Wheel-to-wheel Running Board coverage
- Three-phase paint process resists chipping and scratching from road surface debris
- Serrated, flanged nut fasteners resist vibration
- All hardware meets DaimlerChrysler Corporation's 250-hour salt-spray test
- E-coated brackets prevent corrosion, meet DaimlerChrysler Corporation's side impact fuel system integrity standards
- Support brackets are designed to minimize installation time
- Skid-resistant surface provides added traction
- Running Boards were designed by the DaimlerChrysler Corporation Engineering Team for DaimlerChrysler Corporation minivans
- Mopar Accessories are covered by either the 3-year/36,000-mile New Vehicle Limited Warranty, or the 12-month/12,000-mile Mopar Basic Limited Warranty, whichever is more favorable to the customer

COMPETITORS?*

- Do the Running Boards have to be painted before installation? Do they match the body colors?
- Are the end guards made of fiberglass, which may chip or crack easily?
- Does the surface have three coats for protection?
- Are the fasteners made of plain steel, which may rust?
- Will vibration loosen the fasteners?
- Is the protective finish enamel?
- Will it chip?
- Will the brackets and fasteners pass a 250-hour salt-spray test?
- Are DaimlerChrysler Corporation's fuel system integrity standards met?
- Have brackets been impact-tested?
- Is the bracket system an "erector set," i.e., a lot of holes for multiple applications?
- Is a skid-resistant stepping surface provided?
- Is it designed for DaimlerChrysler Corporation minivans?
- Does the warranty compare?

*Check your market for your competitive situation.
Santoprene is a registered trademark of Monsanto Company.

RUNNING BOARDS, PREMIUM MOLDED, MINIVAN

Vehicle Line	MYO	MYI	Application Remarks	Part Number	Instl Time	Group	Sugg Retail Price
RUNNING BOARDS, MOLDED — BODY COLOR — MINIVAN							
Minivan (LWB Only)	2000	2000	Shale Green (XGR), for long wheelbase, w/o splash guards	82205399	1.0	T	515.00
	2000	1998	Deep Slate (VAW), for long wheelbase w/o splash guards	82204319	1.0	T	510.00
	2000	1999	Aquamarine (XQW), for long wheelbase w/o splash guards	82205131	1.0	T	520.00
	2000	1999	Bright Silver (WS2), for long wheelbase, w/o splash guards	82205132	1.0	T	520.00
	2000	1999	Inferno Red (WEL), for long wheelbase, w/o splash guards	82205133	1.0	T	520.00
	2000	1999	Patriot Blue (WB7), for long wheelbase, w/o splash guards	82205134	1.0	T	520.00
	2001	1998	Primed for painting, for long wheelbase w/o splash guards	82206619	1.0	T	440.00
	2001	1999	Aquamarine (XQW), for long wheelbase w/o splash guards	82206234	1.0	T	515.00
	2001	1999	Bright Silver (WS2), for long wheelbase w/o splash guards	82206232	1.0	T	515.00
	2001	2001	Dark Garnet Red (QRV), for long wheelbase w/o splash guards	82206242	1.0	T	515.00
	2001	1999	Inferno Red (WEL), for long wheelbase w/o splash guards	82206226	1.0	T	515.00
	2001	1999	Patriot Blue (WB7), for long wheelbase w/o splash guards	82206230	1.0	T	515.00
	2001	2000	Shale Green (XGR), for long wheelbase w/o splash guards	82206228	1.0	T	515.00
	2001	2001	Steel Blue (XBQ), for long wheelbase w/o splash guards	82206238	1.0	T	515.00
	2001	2001	Sterling Blue (YB2) for long wheelbase w/o splash guards	82206240	1.0	T	515.00
	2001	2001	Stone White (SW1), for long wheelbase w/o splash guards	82206236	1.0	T	515.00
	2000	1998	Champagne Pearl (VTE), for long wheelbase w/o splash guards	82206386	1.0	T	515.00
	Minivan (SWB Only)	2001	1998	Primed for painting, for short wheelbase w/o splash guards	82206620	1.0	T
2001		1999	Aquamarine (XQW), for short wheelbase w/o splash guards	82206235	1.0	T	490.00
2001		1999	Bright Silver (WS2), for short wheelbase w/o splash guards	82206233	1.0	T	490.00
2001		1998	Champagne (VTE), for short wheelbase w/o splash guards	82206241	1.0	T	490.00
2001		2001	Dark Garnet Red (QRV), for short wheelbase w/o splash guards	82206243	1.0	T	490.00
2001		1999	Inferno Red (WEL), for short wheelbase w/o splash guards	82206227	1.0	T	490.00
2001		1999	Patriot Blue (WB7), for short wheelbase w/o splash guards	82206231	1.0	T	490.00
2001		2000	Shale Green (XGR), for short wheelbase w/o splash guards	82206229	1.0	T	490.00
2001		2001	Steel Blue (XBQ), for short wheelbase w/o splash guards	82206239	1.0	T	490.00
2001		2001	Stone White (SW1), for short wheelbase w/o splash guards	82206237	1.0	T	490.00
2000		1999	Aquamarine (XQW), for short wheelbase, w/o splash guards	82205130	1.0	T	500.00
2000		1999	Bright Silver (WS2), for short wheelbase, w/o splash guards	82205129	1.0	T	500.00
2000		1996	Bright White (PW7), for short wheelbase, w/o splash guards	82204752	1.0	T	500.00
2000		1998	Deep Cranberry (PMT), for short wheelbase, w/o splash guards	82204331	1.0	T	500.00
2000		1998	Deep Slate (VAW), for short wheelbase, w/o splash guards	82204333	1.0	T	500.00
2000		1999	Patriot Blue, for short wheelbase, w/o splash guards	82205127	1.0	T	480.00
2000		2000	Shale Green (XGR), for short wheelbase, w/o splash guards	82205398	1.0	T	480.00
2000		1999	Inferno Red (WEL), for short wheelbase, w/o splash guards	82205128	1.0	T	500.00
2000		1998	Deep Slate (VAW), for short wheelbase, w/o splash guards	82206615	1.0	T	510.00
Town & Country (LWB only)		2000	1998	Champagne Pearl (VTE), for long wheelbase, w/o splash guards	82204326	1.0	T
	2000	1998	Deep Slate (VAW), for long wheelbase, w/o splash guards	82204329	1.0	T	520.00
	2000	1998	Deep Cranberry (PMT), for long wheelbase, w/o splash guards	82204327	1.0	T	520.00
	2000	1998	Deep Slate (VAW), for long wheelbase w/o splash guards	82206617	1.0	T	535.00
	2000	1998	Champagne Pearl (VTE), for long wheelbase w/o splash guards	82206386	1.0	T	515.00
Town & Country Limited (FWD & AWD)	2000	1996	Bright White (GW7), for long wheelbase, w/o splash guards	82203548	1.0	T	520.00
	2000	1996	Golden White Pearl (SWP), for long wheelbase, w/o splash guards	82203550	1.0	T	520.00
	2000	1998	Champagne Pearl (VTE), for long wheelbase w/o splash guards	82206386	1.0	T	515.00

RUNNING BOARDS, ALUMINUM, TRUCK



Dodge Ram Van Wagon — Full-length design

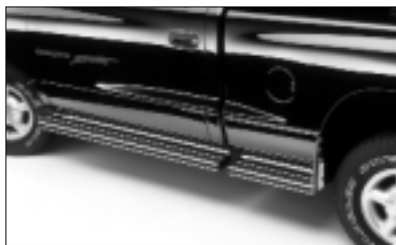

Two-piece full-length design, Regular Cab (shown on Dakota)

MOPAR FEATURES	COMPETITORS?*
<ul style="list-style-type: none"> • Anodized aluminum resists corrosion, pitting, peeling, and is scratch resistant • Serrated flanged nut fasteners resist vibration • E-coated steel support brackets and cadmium plate fasteners meet DaimlerChrysler's 250-hour salt-spray test • Matching front and rear end guards included • Support brackets are designed to minimize installation time • Mopar Side Steps and Running Boards meet or exceed a 250-lb static-load test • Skid-resistant strips provide added traction • Brackets designed to meet FMVSS side-impact standards • Mopar Accessories are covered by either the 3-year/36,000-mile New Vehicle Limited Warranty or the 12-month/12,000-mile Mopar Basic Limited Warranty, whichever is more favorable to the customer 	<ul style="list-style-type: none"> • Is it anodized aluminum? Will it pit or corrode? • Are fasteners made of plain steel, which may rust? Can they vibrate loose? • Do the brackets have an enamel finish, which may chip? Will the brackets and the fasteners pass the 250-hour salt-spray test? • Are end guards included in the price? • Is the bracket system an "erector set" (i.e., a lot of holes for a lot of applications)? • Have they been tested under tough conditions? • Does it have a skid-resistant surface? • Do they meet FMVSS side-impact tests? • Does the warranty compare?

*Check your market for your competitive situation.

INSTALLATION:

- Kits include all hardware and mounting brackets

Vehicle Line	MYO	MYI	Application Remarks	Part Number	Instl Time	Group	Sugg Retail Price
RUNNING BOARDS, ALUMINUM — DAKOTA							
Dakota Club Cab	2001	1997	Club Cab w/6.5 ft. bed	82202752	1.5	T	415.00
RUNNING BOARDS, ALUMINUM — RAM VAN							
Ram Van/Wagon - LWB & Maxi	2001	1998	LWB,w/swing out side doors	82205668	1.5	T	280.00
	2001	1998	LWB,w/sliding side doors	82205669	1.5	T	320.00

RUNNING BOARDS, DIAMOND PLATE, TRUCK



Full-length Running Board design (shown on Ram Pickup)

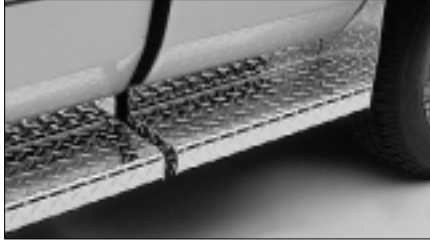

Two-piece system (shown on Ram Pickup)



Dual-rear wheel application (shown on Ram Pickup)

MOPAR FEATURES	COMPETITORS?*
<ul style="list-style-type: none"> • Anodized aluminum resists corrosion, pitting, peeling, and is scratch resistant • Serrated flanged nut fasteners resist vibration • E-coated steel support brackets and cadmium plate fasteners meet DaimlerChrysler's 250-hour salt-spray test • Matching front and rear aluminum end guards included • Support brackets are designed to minimize installation time • Brackets designed to meet FMVSS side-impact standards • 100"-gauge diamond plate aluminum helps to prevent flexing and bending • Mopar Accessories are covered by either the 3-year/36,000-mile New Vehicle Limited Warranty or the 12-month/12,000-mile Mopar Basic Limited Warranty, whichever is more favorable to the customer 	<ul style="list-style-type: none"> • Is it anodized aluminum? Will it pit or corrode? • Are fasteners made of plain steel, which may rust? Can they vibrate loose? • Do the brackets have an enamel finish, which may chip? Will the brackets and the fasteners pass the 250-hour salt-spray test? • Are end guards included in the price? • Is the bracket system an "erector set" (i.e., a lot of holes for a lot of applications)? • Do they meet FMVSS side-impact tests? • Is the aluminum thinner? Will it easily flex or bend? • Does the warranty compare?

*Check your market for your competitive situation.

INSTALLATION:

- Specially designed support brackets reduce installation time
- Kits include all hardware and mounting brackets

Vehicle Line	MY0	MY1	Application Remarks	Part Number	Instl Time	Group	Sugg Retail Price
RUNNING BOARDS, DIAMOND PLATE — RAM PICKUP							
Ram Pickup - Club or Quad Cab	2001	1998	Cab sections only, Quad Cab™ or Club Cab	82205942	0.8	T	310.00
Ram Pickup - Regular Cab (All)	2001	1994	Cab sections only, Regular Cab	82205941	0.8	T	250.00
Ram Pickup w/6.5 Ft. Bed	2001	1994	Bed sections only, 6.5 ft. bed	82205943	0.8	T	148.00
Ram Pickup w/8.0 Ft. Bed	2001	1994	Bed sections only, 8.0 ft. bed, 1500 & 2500 Models	82205944	0.8	T	210.00
	2001	1994	Bed sections only, 3500 Dually Model	82205945	0.8	T	265.00

RUNNING BOARDS, MOLDED, TRUCK

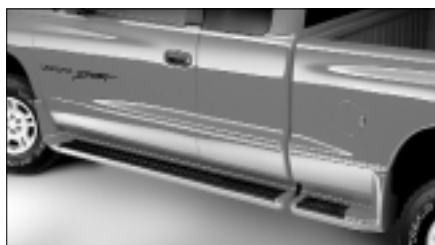

MOPAR FEATURES

- Three-phase original equipment paint process includes a base coat, top color coat and a Clear Coat for durability
- Resists chipping and scratching
- Santoprene® cladding and aluminum substructure resist rust
- Premium Santoprene rubber cladding over roll formed steel with front and rear Molded End Guards
- Serrated flanged nut fasteners resist vibration; E-coated steel support brackets and cadmium plate fasteners meet DaimlerChrysler's 250-hour salt-spray test
- Support brackets are designed to minimize installation time
- Authentic accessory produced by Dodge Design Team to fit Ram's unique contours
- Mopar Accessories are covered by either the 3-year/36,000-mile New Vehicle Limited Warranty or the 12-month/12,000-mile Mopar Basic Limited Warranty, whichever is more favorable to the customer

COMPETITORS?*

- Do the brackets have an enamel finish, which may chip? Will the brackets and the fasteners pass the 250-hour salt-spray test?
- Are fewer brackets used?
- Only Mopar Accessories are designed by the creators of Ram Pickup
- Does the warranty compare?

*Check your market for your competitive situation.
Santoprene is a registered trademark of Monsanto Company.

Vehicle Line	MYO	MYI	Application Remarks	Part Number	Instl Time	Group	Sugg Retail Price
RUNNING BOARDS, MOLDED — DURANGO							
Durango	2000	1998	Black, Molded-in Color	82205250	1.5	T	370.00
	2000	2000	Aquamarine (PQW)	82205472	1.0	T	620.00
	2001	2000	Bright Platinum (PS4)	82205466	1.0	T	620.00
	2001	2000	Bright White (PWT)	82205465	1.0	T	620.00
	2001	2000	Chili Pepper Red (QEA)	82205470	1.0	T	620.00
	2001	2001	Dark Garnet Red (PRV)	82206543	1.0	T	620.00
	2001	2000	Flame Red (PR4)	82205467	1.0	T	620.00
	2001	2000	Forest Green (PG8)	82205469	1.0	T	620.00
	2001	2000	Gloss Black (QX8)	82205464	1.0	T	620.00
	2000	2000	Light Driftwood (PDA/PFK)	82205468	1.0	T	620.00
	2001	2001	Light Pewter Metallic (QFF)	82206542	1.0	T	620.00
	2001	2000	Patriot Blue (PB7)	82205471	1.0	T	620.00
	2001	2000	Sierra Bronze (PTL)	82205473	1.0	T	620.00

RUNNING BOARDS, MOLDED, TRUCK (CONT.)

Vehicle Line	MYO	MYI	Application Remarks	Part Number	Instl Time	Group	Sugg Retail Price
RUNNING BOARDS, MOLDED, BODY COLOR — DAKOTA*							
Dakota Club Cab	2001	2001	Amber Fire (XV3), Club Cab w/6.5' bed	82207038	1.5	T	755.00
	2001	2001	Bright Silver Metallic (WS2), Club Cab w/6.5' bed	82207039	1.5	T	755.00
	2001	1997	Bright White (PW7), Club Cab w/6.5' bed	82202654	1.5	T	700.00
	2000	1998	Deep Amethyst (PCN), Club cab w/6.5' bed	82204003	1.5	T	735.00
	2000	1997	Emerald Green (PGF), Club Cab w/6.5' bed	82202659	1.5	T	735.00
	2001	1997	Black (PX8), Club Cab w/6.5' bed	82202649	1.5	T	755.00
	2001	1997	Flame Red (PR4), Club Cab w/6.5' bed	82202669	1.5	T	755.00
	2001	1998	Forest Green (PG8), Club Cab w/6.5' bed	82204002	1.5	T	755.00
	2001	1998	Intense Blue (PB3), Club Cab w/6.5' bed	82204004	1.5	T	755.00
Dakota Regular Cab	2001	2001	Bright Silver Metallic (WS2), Regular Cab w/6.5' bed	82207040	1.5	T	700.00
	2001	2001	Amber Fire (XV3), Regular Cab w/6.5' bed	82207041	1.5	T	700.00
	2000	1998	Deep Amethyst (PCN), Regular Cab w/6.5' bed	82204000	1.5	T	680.00
	2000	1997	Light Driftwood (PFK), Regular Cab w/6.5' bed	82202661	1.5	T	680.00
	2000	1997	Metallic Red (PRF), Regular Cab w/6.5' bed	82202671	1.5	T	680.00
	2001	1997	Black (PX8), Regular Cab w/6.5' bed	82202646	1.5	T	700.00
	2001	1997	Bright White (PW7), Regular Cab w/6.5' bed	82202651	1.5	T	700.00
	2001	1997	Flame Red (PR4), Regular Cab w/6.5' bed	82202666	1.5	T	680.00
	2001	1998	Forest Green (PG8), Regular Cab w/6.5' bed	82203999	1.5	T	700.00
2001	1998	Intense Blue (PB3), Regular Cab w/6.5' bed	82204001	1.5	T	700.00	
RUNNING BOARDS, MOLDED, BODY COLOR — RAM PICKUP†							
Ram 1500/2500 - Club or Quad Cab, 8.0' Bed	2000	1998	Chestnut, Quad Cab or Club Cab w/8.0' bed	82203315	1.5	T	810.00
	2000	1998	Deep Amethyst (PCN/PCU), Quad Cab or Club Cab w/8.0' bed	82203938	1.5	T	810.00
	2000	1998	Emerald Green (PGF/PCF), Quad Cab or Club Cab w/8.0' bed	82203054	1.5	T	810.00
	2000	1998	Light Driftwood (PFA/PFK), Quad Cab or Club Cab w/8.0' bed	82203062	1.5	T	810.00
	2000	1998	Metallic Red (PRF/PRC), Quad Cab or Club Cab w/8.0' bed	82203299	1.5	T	810.00
	2001	2001	Amber Fire, Quad Cab or Club Cab w/8.0' bed	82206845	1.5	T	835.00
	2001	1998	Black (PX8), Quad Cab or Club Cab w/8.0' bed	82203050	1.5	T	835.00
	2001	2001	Bright Silver Metallic, Quad Cab or Club Cab w/8.0' bed	82206846	1.5	T	835.00
	2001	1998	Bright White (PW7), Quad Cab or Club Cab w/8.0' bed	82203042	1.5	T	835.00
	2001	1998	Dark Garnet Red (PRV), Quad Cab or Club Cab w/8.0' bed	82205785	1.5	T	835.00
	2001	1998	Flame Red (PR4), Quad Cab or Club Cab w/8.0' bed	82203046	1.5	T	835.00
	2001	1998	Forest Green (PG8), Quad Cab or Club Cab w/8.0' bed	82203934	1.5	T	835.00
	2001	1998	Intense Blue (PB3), Quad Cab or Club Cab w/8.0' bed	82203942	1.5	T	835.00
	2001	2000	Patriot Blue (PBT/PB7), Quad Cab or Club Cab w/8.0' bed	82205784	1.2	T	835.00
	2001	2000	Sierra Bronze (PTL), Quad Cab or Club Cab w/8.0' bed	82205786	1.5	T	835.00

*NA with Quad Cab™

† Not for use with Mopar Wheel Flares.

RUNNING BOARDS, MOLDED, TRUCK (CONT.)

Vehicle Line	MY0	MY1	Application Remarks	Part Number	Instl Time	Group	Sugg Retail Price
RUNNING BOARDS, MOLDED, BODY COLOR — RAM PICKUP*							
Ram Club or Quad Cab w/6.5' Bed	2001	2001	Amber Fire (XVL), Quad or Club Cab w/6.5' bed	82206847	1.5	T	755.00
	2001	2001	Bright Silver Metallic (WS2), Quad or Club Cab w/6.5' bed	82206848	1.5	T	755.00
	2000	1998	Chestnut, Quad Cab or Club Cab w/6.5' bed	82203313	1.5	T	735.00
	2000	1998	Deep Amethyst (PCN/PCU), Quad Cab or Club Cab w/6.5' bed	82203937	1.5	T	735.00
	2000	1998	Emerald Green (PGF/PCF), Quad Cab or Club Cab w/6.5' bed	82203052	1.5	T	735.00
	2000	1998	Light Driftwood (PFA/PFK), Quad Cab or Club Cab w/6.5' bed	82203060	1.5	T	735.00
	2000	1998	Metallic Red (PRF/PRC), Quad Cab or Club Cab w/6.5' bed	82203297	1.5	T	735.00
	2000	1999	Solar Yellow (PYH) Quad Cab or Club Cab w/6.5' bed	82204913	1.5	T	735.00
	2001	1998	Black (PX8), Quad Cab or Club Cab w/6.5' bed	82203048	1.5	T	755.00
	2001	1998	Bright White (PW7), Quad Cab or Club Cab w/6.5' bed	82203040	1.5	T	755.00
	2001	2000	Dark Garnet Red (PRV), Quad Cab or Club Cab w/6.5' bed	82205746	1.5	T	755.00
	2001	1998	Flame Red (PR4), Quad Cab or Club Cab w/6.5' bed	82203044	1.5	T	755.00
	2001	1998	Forest Green (PG8), Quad Cab or Club Cab w/6.5' bed	82203933	1.5	T	755.00
	2001	1998	Intense Blue (PB3), Quad Cab or Club Cab w/6.5' bed	82203941	1.5	T	755.00
	2001	2000	Patriot Blue (PBT/PB7), Quad Cab or Club Cab w/6.5' bed	82205745	1.5	T	755.00
	2001	2000	Sierra Bronze (PTL), Quad Cab or Club Cab w/6.5' bed	82205747	1.5	T	755.00
	2001	1994	Bright White (PW7), Regular Cab w/6.5' bed	82203039	1.5	T	645.00
	2000	1994	Emerald Green (PGF/PCF), Regular Cab w/6.5' bed	82203051	1.5	T	645.00
	2000	1994	Light Driftwood (PFA/PFK), Regular Cab w/6.5' bed	82203059	1.5	T	645.00
	2000	1994	Solar Yellow (PYH) Regular Cab w/6.5' bed	82204912	1.5	T	645.00
	2001	2001	Amber Fire (QVL), Regular Cab w/6.5' bed	82206849	1.5	T	660.00
	2001	1994	Black (PX8), Regular Cab w/6.5' bed	82203047	1.5	T	660.00
	2001	2001	Bright Silver Metallic(QSB), Regular Cab w/6.5' bed	82206850	1.5	T	660.00
	2001	1998	Deep Amethyst (PCN/PCU), Regular Cab w/6.5' bed	82203935	1.5	T	660.00
	2001	1994	Flame Red (PR4), Regular Cab w/6.5' bed	82203043	1.5	T	660.00
	2001	1998	Forest Green (PG8), Regular Cab w/6.5' bed	82203931	1.5	T	660.00
	2001	1998	Intense Blue (PB3), Regular Cab w/6.5' bed	82203939	1.5	T	660.00
	2001	2000	Patriot Blue (PBT/PB7), Regular Cab w/6.5' bed	82205742	1.5	T	660.00
	2001	2000	Dark Garnet Red (PRV), Regular Cab w/6.5' bed	82205743	1.5	T	660.00
	2001	2000	Sierra Bronze (PTL), Regular Cab w/6.5' bed	82205744	1.5	T	660.00
Ram Regular Cab w/8.0' Bed	2000	1994	Light Driftwood (PFA/PFK), Regular Cab w/8.0' bed	82203061	1.5	T	715.00
	2000	1996	Metallic Red (PRF/PRC), Regular Cab w/8.0' bed	82203298	1.5	T	715.00
	2001	1994	Black (PX8), Regular Cab w/8.0' bed	82203049	1.5	T	735.00
	2001	1994	Bright White (PW7), Regular Cab w/8.0' bed	82203041	1.5	T	735.00
	2001	1998	Deep Amethyst (PCN/PCU), Regular Cab w/8.0' bed	82203936	1.5	T	735.00
	2001	1994	Flame Red (PR4), Regular Cab w/8.0' bed	82203045	1.5	T	735.00
	2001	1998	Forest Green (PG8), Regular Cab w/8.0' bed	82203932	1.5	T	735.00
	2001	1998	Intense Blue (PB3), Regular Cab w/8.0' bed	82203940	1.5	T	735.00
	2001	1994	Emerald Green (PGF/PCF), Regular Cab w/8.0' bed	82203053	1.5	T	715.00

*Not for use with Mopar Wheel Flares.

RUNNING BOARDS, MOLDED, MATTE BLACK



Running Boards with End Guards
(shown on Ram Pickup)



Improved cab access
(shown on Ram Pickup)

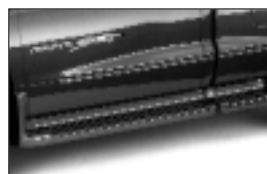

Running Boards with End
Guards (shown on Dakota)

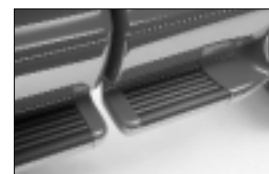

Mounts directly to body
(shown on Dakota)

MOPAR FEATURES

- Integrated molded end guards at front; rear bed sections sold with or without end guards
- Authentic Dodge truck design
- Santoprene® cladding and aluminum substructure resist rust
- Custom end guards (made of TPO) resist cracking; end guards and end caps constructed of blow-molded Salflex® 255 plastic; cladding matches color (black) and texture of body moldings
- Serrated flanged nut fasteners resist vibration
- E-coated steel support brackets and cadmium plate fasteners meet DaimlerChrysler's 250-hour salt-spray (CASS) test
- Brackets designed to meet DaimlerChrysler's fuel system standards for side-impact protection
- Support brackets are designed to minimize installation time
- Skid-resistant surface provides added traction
- Four brackets per side, two per section
- Two-piece design eliminates noise transmission from bed to cab
- Body movement due to severe terrain will not affect split design boards
- Wheel-to-wheel Running Boards offered in split design only, include front cab sections and rear bed sections
- Mopar Accessories are covered by either the 3-year/36,000-mile New Vehicle Limited Warranty or the 12-month/12,000-mile Mopar Basic Limited Warranty, whichever is more favorable to the customer

COMPETITORS?*

- Is it made of steel, which may rust?
- Are fasteners made of plain steel, which may rust? Can they vibrate loose?
- Do the brackets have an enamel finish, which may chip? Will the brackets and the fasteners pass the 250-hour salt-spray test?
- Were brackets designed to meet DaimlerChrysler Corporation's fuel system requirements?
- Is the bracket system an "erector set" (i.e., a lot of holes for a lot of applications)?
- Does it have a skid-resistant surface?
- Are fewer brackets used?
- Does the warranty compare?

*Check your market for your competitive situation.

INSTALLATION:

- For use with Wheel Flares (Dakota/Durango)
- Specially designed support brackets reduce installation time
- Cab-length boards mounted to vehicle with two wide custom-made brackets per side
- Rear bed boards are also mounted to vehicle with two wide custom-made brackets per side
- Available for Regular Cab, Club Cab® and Quad Cab™ models

RUNNING BOARDS, MOLDED, MATTE BLACK (CONT.)

Vehicle Line	MY0	MY1	Application Remarks	Part Number	Instl Time	Group	Sugg Retail Price
RUNNING BOARDS, MOLDED, MATTE BLACK — RAM PICKUP*							
Ram 1500/2500 Regular Cab w/8.0' Bed	2001	1994	Regular Cab w/8.0 ft. bed, except 3500 Models	82202467	1.5	T	550.00
Ram 3500 Quad Cab	2001	1998	Quad Cab or Club Cab w/8.0 ft. bed, 3500 Models	82202470	1.5	T	455.00
Ram 3500 Regular Cab	2001	1994	Regular Cab w/ 8.0 ft. bed	82202468	1.5	T	435.00
Ram Club or Quad Cab w/6.5' Bed	2001	1998	Quad Cab or Club Cab w/6.5 ft. bed	82202469	1.5	T	580.00
Ram Pickup - Club or Quad Cab	2001	1998	Quad Cab or Club Cab, cab section only, Chassis Cab	82202465	0.8	T	320.00
Ram Pickup - Regular Cab (All)	2001	1994	Regular Cab, cab section only, Chassis Cab	82202464	0.8	T	290.00
Ram 3500 Quad Cab, Ram 3500 Regular Cab	2001	1994	Box Extension 8.0 ft. - bed section only	82202474	0.8	T	162.00
Ram Regular Cab w/6.5' Bed	2001	1994	Regular Cab w/6.5 ft. bed	82202466	1.5	T	490.00

*Not for use with Mopar Wheel Flares.

SADDLE BAGS



Saddle Storage Bag (shown on Wrangler)



Secured to Sports Bar with hook-and-loop straps

MOPAR FEATURES	COMPETITORS?*
<ul style="list-style-type: none"> • OE-style zippers • Great for in-line skates and other sports equipment • Mopar Accessories are covered by either the 3-year/36,000-mile New Vehicle Limited Warranty, or the 12-month/12,000-mile Mopar Basic Limited Warranty, whichever is more favorable to the customer 	<ul style="list-style-type: none"> • Is it a cheaper, vinyl material? • Does the color match other vehicle materials? • Does the warranty compare?

*Check your market for your competitive situation.

INSTALLATION:

- No drilling required
- Secures to the Sports Bar with hook-and-loop straps
- Removable for easy transport

Vehicle Line	MYO	MYI	Application Remarks	Part Number	Instl Time	Group	Sugg Retail Price
SADDLE BAGS							
Wrangler	2001	1997	Black Denim (1 per kit)	82202388	D.I.Y.	T	66.00
	2000	1997	Stone White (1 per kit)	82202390	D.I.Y.	T	65.00

SEATBACK BACKPACK



Unclip for Backpack



Seatback Backpack (shown in Wrangler)



Seatback Backpack (shown in PT Cruiser)

MOPAR FEATURES

- Custom-fit storage bag that fits under head restraint
- Water-resistant, polyester, packcloth material for durability
- Large internal storage with buckle closure, two side zippered pockets and two outside net pockets
- Features Jeep® and Ram's Head logos
- Color-matched to interior
- Mopar Accessories are covered by either the 3-year/36,000-mile New Vehicle Limited Warranty, or the 12-month/12,000-mile Mopar Basic Limited Warranty, whichever is more favorable to the customer

COMPETITORS?*

- Is it loose fitting?
- Does it flap away from seatback?
- Logos are exclusive to DaimlerChrysler Corporation, Jeep, Dodge and Mopar
- Is it a universal color?
- Does the warranty compare?

*Check your market for your competitive situation.

INSTALLATION:

- Easy to install
- Slip under head restraint and clip strap around base of seat to keep securely in place
- Simply unclip the backpack from the seatback organizer and take the backpack with you

Vehicle Line	MYO	MYI	Application Remarks	Part Number	Instl Time	Group	Sugg Retail Price
SEATBACK BACKPACK							
Cherokee	2001	1991	Agate w/Mist Gray trim, vehicles w/non-removable headrests	82203508	D.I.Y.	T	112.00
	2001	1991	Agate w/Mist Gray trim, vehicles w/removable headrests	82203503	D.I.Y.	T	112.00
	2001	1991	Green w/Saddle trim, vehicles w/non-removable headrests	82203509	D.I.Y.	T	112.00
	2001	1991	Green w/Saddle trim, vehicles w/removable headrests	82203505	D.I.Y.	T	112.00
Dakota Club Cab	2001	1997	Black, w/Gray trim	82204158	D.I.Y.	T	112.00
	2001	1997	Green, w/Tan trim	82204159	D.I.Y.	T	112.00
Durango	2001	1998	Black, w/Gray trim	82204158*	D.I.Y.	T	112.00
	2001	1998	Green, w/Tan trim	82204159*	D.I.Y.	T	112.00
Minivan (All)	2000	1996	Gray w/Black trim, w/Pentastar logo	82203588	D.I.Y.	T	101.00
	2000	1996	Green w/Black trim, w/Pentastar logo	82203589	D.I.Y.	T	101.00
Neon, PT Cruiser	2001	2000	Black, w/organizer	82204544	D.I.Y.	T	75.00
Wrangler	2001	1997	Black w/Gray trim	82202399	D.I.Y.	T	112.00
	2001	1997	Green w/Saddle trim	82202400	D.I.Y.	T	112.00

*Does not fit leather seats.

SEAT COVERS



Seat Covers (Ram Pickup)



Dakota

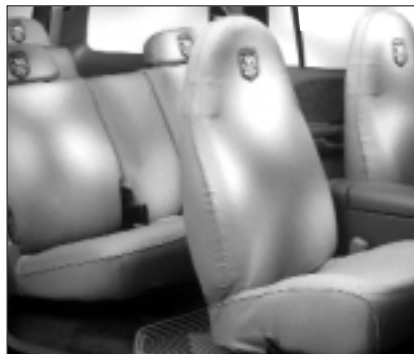

Durango

MOPAR FEATURES

- Custom tailored for a perfect fit
- Will not cover seat controls
- Tailored openings for all latches, pulls and other seat hardware
- Comfortable yet durable poly/cotton fabric protects original upholstery from dirt and tears
- Handy pockets add storage space
- Three- and four-piece designs
- Easily removed for washing
- Seat covers feature vehicle logo
- Match vehicle interior color
- Manufactured to DaimlerChrysler specifications for durability, flame retardants, and other specifications not available in aftermarket seat covers
- Mopar Accessories are covered by either the 3-year/36,000-mile New Vehicle Limited Warranty or the 12-month/12,000-mile Mopar Basic Limited Warranty, whichever is more favorable to the customer

COMPETITORS?*

- Are they only available in one standard color that does not match your interior?
- Have they been tested for durability and long life?
- Does the warranty compare?

*Check your market for your competitive situation.

INSTALLATION:

- Easy installation
- No tools required and takes only minutes

SEAT COVERS (CONT.)

Vehicle Line	MYO	MYI	Application Remarks	Part Number	Instl Time	Group	Sugg Retail Price	
SEAT COVERS								
Dakota (All)	2001	2001	Dark Slate, front, 3 pieces, w/ Rams Head logo	82206738	0.3	T	146.00	
	2001	2001	Taupe, front, 3 pieces, w/ Rams Head logo	82206739	0.3	T	146.00	
	2000	2000	Agate, front, 3 pieces, w/Rams head logo	82205480	0.3	T	143.00	
	2000	2000	Mist Gray, front, 3 pieces, w/Rams head logo	82205479	0.3	T	143.00	
Dakota Quad Cab	2001	2001	Dark Slate, rear, 4 pieces	82206740	0.3	T	96.00	
	2001	2001	Taupe, rear, 4 pieces	82206741	0.3	T	96.00	
	2000	2000	Agate, rear, 4 pieces	82205177	0.3	T	95.00	
	2000	2000	Mist Gray, rear, 4 pieces	82205176	0.3	T	95.00	
Durango	2000	1999	Agate, 2nd seat, 8 pieces, w/ Rams head logo	82205234	0.5	T	171.00	
	2000	1999	Agate, 2nd seat, 8 pieces, w/ Rams head logo	82205230	0.5	T	171.00	
	2000	1998	Agate, 3rd seat, 4 pieces, w/ Rams head logo	82205233	0.7	T	129.00	
	2000	1998	Agate, 3rd seat, 4 pieces, w/ Rams head logo	82206592	0.7	T	129.00	
	2000	1998	Agate, front, 3 pieces, driver, passenger and middle bottom seats, w/Rams Head Logo	82205227	0.3	T	143.00	
	2000	1999	Camel, 2nd seat, 8 pieces, w/ Rams head logo	82205228	0.5	T	171.00	
	2000	1998	Camel, 3rd seat, 4 pieces, w/ Rams head logo	82205231	0.3	T	129.00	
	2000	1998	Camel, 3rd seat, 4 pieces, w/ Rams head logo	82206591	0.3	T	129.00	
	2000	1998	Camel, front, 3 pieces, w/ Rams head logo	82205225	0.3	T	143.00	
	2000	1999	Mist Gray, 2nd seat, 8 pieces, w/ Rams head logo	82204745	0.5	T	171.00	
	2000	1999	Mist Gray, 2nd seat, 8 pieces, w/ Rams head logo	82205229	0.5	T	171.00	
	2000	1998	Mist Gray, 3rd seat, 4 pieces, w/ Rams head logo	82205232	0.3	T	129.00	
	2000	1998	Mist Gray, 3rd seat, 4 pieces, w/ Rams head logo	82206590	0.3	T	129.00	
	2000	1998	Mist Gray, front, 3 pieces, w/ Rams head logo	82205226	0.3	T	143.00	
	2001	2001	Dark Slate, 2nd seat, 8 pieces w/ Rams head logo - 5 passenger, w/o third seat	82206726	0.5	T	171.00	
	2001	2001	Dark Slate, 2nd seat, 8 pieces, w/ Rams head logo - 8 passenger	82206723	0.5	T	171.00	
	2001	2001	Dark Slate, 3rd seat, 4 pieces, Rams head logo	82206729	0.7	T	129.00	
	2001	2001	Dark Slate, front, 3 pieces, w/ Rams head logo	82206720	0.3	T	143.00	
	2001	2001	Sandstone, 2nd seat, 8 pieces w/ Rams head logo - 5 passenger, w/o third seat	82206728	0.5	T	171.00	
	2001	2001	Sandstone, 2nd seat, 8 pieces w/ Rams head logo - 8 passenger	82206725	0.5	T	171.00	
	2001	2001	Sandstone, 3rd seat, 4 pieces w/ Rams head logo	82206731	0.7	T	129.00	
	2001	2001	Sandstone, front, 3 pieces w/ Rams head logo	82206722	0.3	T	143.00	
	2001	2001	Taupe, 2nd seat, 8 pieces w/ Rams head logo - 5 passenger, w/o third seat	82206727	0.5	T	171.00	
	2001	2001	Taupe, 2nd seat, 8 pieces, w/ Rams head logo - 8 passenger	82206724	0.5	T	171.00	
	2001	2001	Taupe, 3rd seat, 4 pieces w/ Rams head logo	82206730	0.7	T	129.00	
	2001	2001	Taupe, front, 3 pieces w/ Rams head logo	82206721	0.3	T	143.00	
	Ram Pickup - Club or Quad Cab	2001	1999	Agate, 4 pieces, complete set, w/ Rams head logo	82205818	0.4	T	210.00
		2001	1998	Camel, 4 pieces, complete set, w/ Rams head logo	82204606	0.4	T	210.00
2001		1998	Mist Gray, 4 pieces, complete set, w/ Rams head logo	82204605	0.4	T	210.00	

SEAT COVERS (CONT.)

Vehicle Line	MYO	MYI	Application Remarks	Part Number	Instl Time	Group	Sugg Retail Price
SEAT COVERS (CONT.)							
Ram Pickup - Regular Cab (All)	2001	1999	Agate, front, 3 pieces, w/Ram's head logo	82205819	0.4	T	148.00
	2001	1994	Camel, front, 3 pieces, w/Ram's head logo	82203668	0.3	T	148.00
	2001	1994	Mist Gray, front, 3 pieces, w/Ram's head logo	82203669	0.4	T	148.00
Wrangler	2001	1997	Black, rear seat cover, 1 piece, w/ Jeep logo	82206608	0.4	T	140.00
	2001	1997	Tan and Black, rear, 1 -piece, w/ Jeep logo	82206606	0.4	T	140.00
	2001	1997	Black, front, 2 pieces, w/Jeep logo	82206607	0.4	T	190.00
	2001	1997	Tan and Black, front, 2 -pieces, w/ Jeep logo	82206605	0.4	T	190.00

SIDE STEPS, MOLDED, JEEP®



Molded Side Step with step pad (shown on Grand Cherokee)



Molded Side Step (shown on Cherokee)

MOPAR FEATURES

- Made of high-impact TPO plastic cladding with a steel substructure
- Steps are custom contoured to Jeep wheel flares for an integrated look
- Mounts to Jeep substructure for durability and support
- Includes skid-resistant stepping surface
- Available in matte black and select body colors
- Mopar Accessories are covered by either the 3-year/36,000-mile New Vehicle Limited Warranty, or the 12-month/12,000-mile Mopar Basic Limited Warranty, whichever is more favorable to the customer

COMPETITORS?*

- Is a skid-resistant surface provided?
- Will it rust?
- Does vibration loosen the fasteners?
- Does the warranty compare?

*Check your market for your competitive situation.

Vehicle Line	MYO	MYI	Application Remarks	Part Number	Instl Time	Group	Sugg Retail Price
SIDE STEPS, MOLDED — CHEROKEE							
Cherokee	2001	1997	Black (PX8)	82203396	1.5	T	480.00
	2001	1997	Black Low Gloss, matches SE/Sport trim	82203461	1.5	T	480.00
	2001	1997	Flame Red (PR4)	82203395	1.5	T	480.00
	2001	1997	Stone White (PW1)	82203399	1.5	T	465.00
	2001	1997	Gunmetal (P07)	82203394	1.5	T	480.00
SIDE STEPS, MOLDED — GRAND CHEROKEE							
Grand Cherokee Laredo	2001	1999	Black, Laredo only	82204598	1.5	T	495.00
	2001	1999	Driftwood, matches cladding, Laredo only	82204596	1.5	T	495.00
	2001	2000	Gray, matches cladding, Laredo only	82205221	1.5	T	495.00
	2001	1999	Silver aluminum, Laredo only	82204599	1.5	T	510.00
	2001	1999	Chrome, Laredo only	82204595	1.5	T	540.00
Grand Cherokee Limited	2001	1999	Black, Limited only	82204768	1.5	T	495.00
	2001	1999	Silver Aluminum, Limited only	82204769	1.5	T	510.00
	2001	1999	Chrome, Limited only	82204767	1.5	T	540.00

SIDE STEPS, OE-STYLE, WRANGLER



Side Step (shown on Wrangler)

MOPAR FEATURES	COMPETITORS?*
<ul style="list-style-type: none"> • Same as OE • Design complements sloped fender flare • Molded black plastic construction • Provide easier access to vehicle • Mopar Accessories are covered by either the 3-year/36,000-mile New Vehicle Limited Warranty, or the 12-month/12,000-mile Mopar Basic Limited Warranty, whichever is more favorable to the customer 	<ul style="list-style-type: none"> • Is it designed to complement sloped fender flare? • Is it molded black plastic? • Does the warranty compare?

*Check your market for your competitive situation.

INSTALLATION:

No drilling required — uses collapsible nuts for installation

Vehicle Line	MYO	MYI	Application Remarks	Part Number	Instl Time	Group	Sugg Retail Price
SIDE STEPS, ORIGINAL EQUIPMENT STYLE — WRANGLER							
Wrangler	2000	1997	Black, molded, same as original equipment	82204304	1.5	T	113.00
Wrangler - Sport & SE	2001	2001	Black, molded, same as original equipment	82206456	1.5	T	113.00

SIDE STEPS, TUBULAR, JEEP®



Tubular Side Step (shown on Wrangler)



Tubular Side Step (shown on Cherokee)

MOPAR FEATURES	COMPETITORS?*
<ul style="list-style-type: none"> • Mopar uses stainless steel fasteners and hardware • Constructed of corrosion-resistant aluminum with skid-resistant surface • Mandrel tubing bends for a full, round appearance (no wrinkles) • Unique one-piece design ensures a uniform appearance and fit • Available in chrome, black and silver aluminum • Designed to meet federal fuel system integrity standards • Chrome is designed to meet 44-hour Chrome Accelerated Salt Spray (CASS) Test • Bright hexavalent chrome finish; the chrome finish consists of .001-ductile nickel base coating for strength, covered by .0005-semi-bright nickel seal coat and topped with hexavalent chrome plating that provides a bright, rust-resistant product • Authentic Jeep design approved by Jeep Design Team • Mopar Accessories are covered by either the 3-year/36,000-mile New Vehicle Limited Warranty, or the 12-month/12,000-mile Mopar Basic Limited Warranty, whichever is more favorable to the customer 	<ul style="list-style-type: none"> • Are plain steel fasteners used, which may rust? • Is all hardware stainless steel? • Is it corrosion resistant? • Does it have a skid-resistant surface? • Are tubes bent without mandrel, resulting in a flat or wrinkled appearance? • Will design ensure a uniform appearance and fit? • Will the side steps meet federal fuel system standards? • Does the warranty compare?

*Check your market for your competitive situation.

INSTALLATION:

- Mount directly to frame for added strength and support
- Require some drilling
- Predrilled — no drilling required (Wrangler)
- Recommended use of PN 82202304 Flat Splash Guards to reduce marring of finish from road debris (Wrangler)

Vehicle Line	MYO	MYI	Application Remarks	Part Number	Instl Time	Group	Sugg Retail Price
SIDE STEPS, TUBULAR — CHEROKEE*							
Cherokee	2001	1991	Black steel	82203391	1.0	T	390.00
	2001	1991	Silver aluminum	82203388	1.0	T	405.00
	2001	1991	Chrome steel	82203390	1.0	T	530.00

*Products listed above do not have end guards. They may be installed on vehicles with or without wheel flares.

SIDE STEPS, TUBULAR, JEEP® (CONT.)

Vehicle Line	MYO	MYI	Application Remarks	Part Number	Instl Time	Group	Sugg Retail Price
SIDE STEPS, TUBULAR — WRANGLER*							
Wrangler	2001	1997	Powder-coated Flame Red to match the body color	82202555	0.8	T	335.00
	2001	1997	Black steel	82202137	0.8	T	350.00
	2001	1997	Black aluminum	82202138	0.8	T	390.00
	2001	1997	Silver aluminum	82202139	0.8	T	390.00
	2001	1997	Chrome steel	82202140	0.8	T	435.00

*Products listed above do not have end guards. They may be installed on vehicles with or without wheel flares.

SIDE STEPS, MINI, TRUCK



Mini Side Step

MOPAR FEATURES	COMPETITORS?*
<ul style="list-style-type: none"> • Anodized aluminum resists corrosion, pitting, peeling, and is scratch-resistant • Mopar uses stainless steel fasteners and hardware • Attaches to body flange and cab mounts for strength and durability, restricts movement • Sturdy mounting system helps prevent flexing, specially designed for 4WD or 2WD applications • Provides alternative to wide step designs • Reduces step height 3.5" on 2WD, 5.5" on 4WD • Mopar Accessories are covered by either the 3-year/36,000-mile New Vehicle Limited Warranty or the 12-month/12,000-mile Mopar Basic Limited Warranty, whichever is more favorable to the customer 	<ul style="list-style-type: none"> • Is it anodized aluminum? Will it pit or corrode? • Are plain steel fasteners used, which may rust? • Is all hardware stainless steel? • Does it shake and rattle? • Is it one size fits all? Is it securely mounted? • Do they offer a variety of step styles and sizes? • Does the warranty compare?

*Check your market for your competitive situation.

INSTALLATION:

Sturdy mounting system prevents flexing

Vehicle Line	MYO	MYI	Application Remarks	Part Number	Instl Time	Group	Sugg Retail Price
SIDE STEPS, MINI — RAM PICKUP							
Ram Pickup 4x2	2001	1995	Black aluminum, 2WD, Regular and Club Cab	82401342	1.0	T	122.00
Ram Pickup 4x4	2001	1995	Black aluminum, 4WD, Regular and Club Cab	82401343	1.0	T	122.00

SIDE STEPS, MOLDED, TRUCK

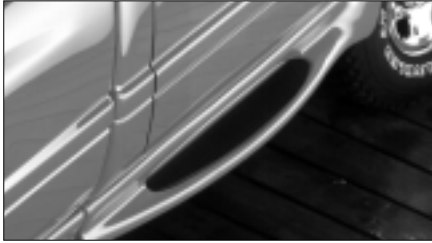

Molded Side Step with Ground Effects on Regular Cab (shown on Ram Pickup)

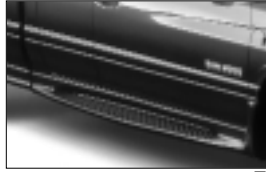

Molded Side Step on Quad Cab™ (shown on Ram Pickup)

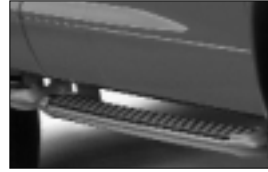

Molded Side Step (shown on Dakota)



Cab and Bed Section (shown on Dakota)



Molded Side Step (shown on Durango)

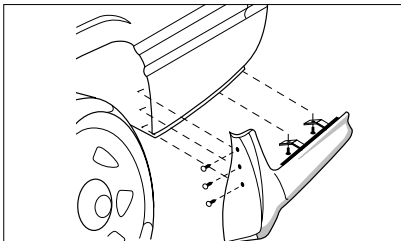

Rear End Guard and Ground Effect

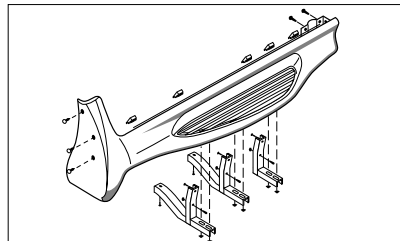

Side Step with three-bracket support per side

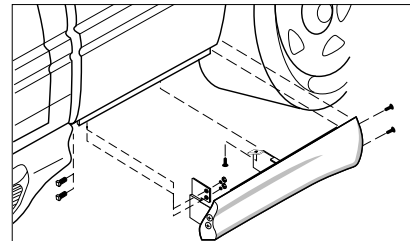

Front bed Ground Effects section

MOPAR FEATURES

- Bayflex® 110-50 polyurethane resists cracking
- Prepainted to match vehicle
- Three brackets support step
- Brackets and fasteners protected to meet 250-hour salt-spray requirement
- Step pad and supporting plate preassembled at factory
- Step pad constructed of Santoprene® TPO
- Ready to install
- Automotive grade finish
- Resists chipping
- Produced by Dodge Design Team to match Dodge truck's unique contours
- Debossed Dodge Ram's Head logo in front portion of Side Step (Ram Pickup with Ground Effects only)
- Mopar Side Steps and Running Boards meet or exceed a 250-lb static-load test
- Quad Cab™ Side Steps feature extended stepping surface for rear access
- Custom designed to fit the contours of Dakota Quad Cab, Side Steps are constructed with an aluminum substructure and feature wide, skid-resistant step pads and molded TPO end caps
- Mopar Accessories are covered by either the 3-year/36,000-mile New Vehicle Limited Warranty or the 12-month/12,000-mile Mopar Basic Limited Warranty, whichever is more favorable to the customer

COMPETITORS?*

- Is it fiberglass, which may chip and/or break in cold weather?
- Is the competition's side step prepainted?
- Are brackets used for support? Is there a protective coating on the hardware?
- Do you have to secure the step pad with glue or screws before installing?
- Does it have to be removed for painting and reinstallation?
- Does it have a gelcoat or fiberglass finish that may chip easily?
- Does it have a "boxy," add-on look? Mopar Accessories are the only genuine Dodge-designed products available for Ram Pickup
- Dodge logo is an exclusive registered trademark of Mopar, Dodge and DaimlerChrysler
- Have they been tested under tough conditions?
- Does stepping surface extend for rear access?
- Does the warranty compare?

*Check your market for your competitive situation.
Bayflex is a registered trademark of Miles Industries.
Santoprene is a registered trademark of Monsanto Company.

SIDE STEPS, MOLDED, TRUCK (CONT.)

INSTALLATION:

- Require cab sections and bed sections for complete installation
- Repainted to match most popular body colors
- Applications include Regular Cab, Club Cab® and Quad Cab™ trucks, with 6.5' and 8.0' bed lengths and standard wheels

Vehicle Line	MYO	MYI	Application Remarks	Part Number	Instl Time	Group	Sugg Retail Price
SIDE STEPS, MOLDED — DAKOTA							
Dakota Club Cab	2000	1997	Solar Yellow (PYH), Club Cab w/6.5' bed	82204923	1.5	T	640.00
	2000	1997	Light Driftwood (PFK), Club Cab w/6.5' bed	82203470	1.5	T	700.00
	2001	1997	Black (PX8), Club Cab w/6.5' bed	82202904	1.5	T	720.00
	2001	1997	Bright White (PW7), Club Cab w/6.5' bed	82202893	1.5	T	720.00
	2001	1997	Flame Red (PR4), Club Cab w/6.5' bed	82202922	1.5	T	720.00
	2001	1998	Forest Green (PG8), Club Cab w/6.5' bed	82204141	1.5	T	720.00
	2001	1998	Intense Blue (PB3), Club Cab w/6.5' bed	82204143	1.5	T	720.00
	2001	2001	Amber Fire (XV3), Club Cab w/6.5' bed	82207042	1.5	T	720.00
	2001	2001	Bright Silver Metallic (WS2), Club Cab w/6.5' bed	82207043	1.5	T	720.00
Dakota Quad Cab	2001	2001	Bright Silver Metallic (WS2), cannot use w/front or rear splash guards	82206541	1.5	T	615.00
	2001	2000	Intense Blue (PB3)	82205055	1.5	T	615.00
	2000	2000	Light Driftwood (PFK)	82205052	1.5	T	600.00
	2001	2000	Amber Fire (PV3)	82205060	1.5	T	615.00
	2001	2000	Black (PX8)	82205050	1.5	T	615.00
	2001	1997	Bright White (PW7)	82205051	1.5	T	615.00
	2001	2000	Dark Garnet Red (PVR)	82205058	1.5	T	615.00
	2001	2000	Flame Red (PR4)	82205053	1.5	T	615.00
	2001	2000	Forest Green (PG8)	82205054	1.5	T	615.00
	2001	2000	Natural aluminum	82205462	1.5	T	615.00
	2001	2000	Patriot Blue (PB7)	82205057	1.5	T	615.00
	2001	2000	Sierra Bronze (PTL)	82205059	1.5	T	615.00
	2001	2000	Chrome	82205463	1.5	T	660.00
Dakota Regular Cab	2000	1997	Light Driftwood (PFK), Regular Cab w/6.5' bed	82203469	1.5	T	640.00
	2000	1997	Metallic Red (PRF), Regular Cab w/6.5' bed	82203467	1.5	T	640.00
	2001	1997	Black (PX8), Regular Cab w/6.5' bed	82202901	1.5	T	660.00
	2001	1997	Bright White (PW7), Regular Cab w/6.5' bed	82202890	1.5	T	660.00
	2001	1997	Flame Red (PR4), Regular Cab w/6.5' bed	82202919	1.5	T	660.00
	2001	1998	Forest Green (PG8), Regular Cab w/6.5' bed	82204144	1.5	T	660.00
	2001	1998	Intense Blue (PB3), Regular Cab w/6.5' bed	82204146	1.5	T	660.00
	2000	1997	Solar Yellow (PYH), Regular Cab w/6.5' bed	82204922	1.5	T	640.00
	2001	2001	Amber Fire (XV3), Regular Cab w/6.5' bed	82207044	1.5	T	660.00
	2001	2001	Bright Silver Metallic (WS2), Regular Cab w/6.5' bed	82207045	1.5	T	660.00

SIDE STEPS, MOLDED, TRUCK (CONT.)

Vehicle Line	MY0	MY1	Application Remarks	Part Number	Instl Time	Group	Sugg Retail Price
SIDE STEPS, MOLDED — DURANGO							
Durango	2001	2001	Garnet Red (XRV)	82206931	1.5	T	600.00
	2001	2001	Light Pewter Metallic (YFF)	82206932	1.5	T	600.00
	2001	2000	Medium Bronze (XTL)	82206933	1.5	T	600.00
	2000	1998	Intense Blue (PB3)	82204025	1.0	T	575.00
	2001	1999	Bright Platinum (PS4)	82205089	1.5	T	600.00
	2000	1998	Light Driftwood (PFK)	82204022	1.0	T	575.00
	2001	1998	Black (PX8)	82204019	1.0	T	600.00
	2001	1998	Bright White (PW7)	82204020	1.0	T	600.00
	2001	1998	Chili Pepper Red (PEA)	82204018	1.0	T	600.00
	2001	1998	Flame Red (PR4)	82204021	1.0	T	600.00
	2001	1998	Forest Green (PG8)	82204023	1.0	T	600.00
	2001	1998	Patriot Blue (PB7)	82204903	1.5	T	600.00
SIDE STEPS, MOLDED — RAM PICKUP							
Ram Club or Quad Cab w/6.5' Bed	2000	1998	Solar Yellow (PYH) Quad Cab or Club Cab w/6.5' bed	82204915	2.0	T	720.00
	2001	1998	Black (PX8), Quad Cab or Club Cab w/6.5' bed	82204291	1.5	T	750.00
	2001	1998	Bright White (PW7), Quad Cab or Club Cab w/6.5' bed	82204288	1.5	T	750.00
	2001	1998	Flame Red (PR4), Quad Cab or Club Cab w/6.5' bed	82204289	1.5	T	750.00
	2001	1998	Forest Green (PG8), Quad Cab or Club Cab w/6.5' bed	82204287	1.5	T	750.00
	2001	1998	Intense Blue (PB3), Quad Cab or Club Cab w/6.5' bed	82204292	1.5	T	750.00
Ram Regular Cab w/6.5' Bed	2000	1997	Light Driftwood (PFA/PFK), Regular Cab w/6.5' bed	82204539	1.5	T	680.00
	2000	1997	Solar Yellow(QYH), Regular Cab w/6.5' bed	82204914	2.0	T	680.00
	2001	1997	Black (PX8), Regular Cab w/6.5' bed	82204298	1.5	T	700.00
	2001	1997	Bright White (PW7), Regular Cab w/6.5' bed	82204295	1.5	T	700.00
	2001	1997	Flame Red (PR4), Regular Cab w/6.5' bed	82204296	1.5	T	700.00
	2001	1997	Forest Green (PG8), Regular Cab w/6.5' bed	82204294	1.5	T	700.00
	2001	1997	Intense Blue (PB3), Regular Cab w/6.5' bed	82204299	1.5	T	700.00

SIDE STEPS, POWER STEP, TRUCK

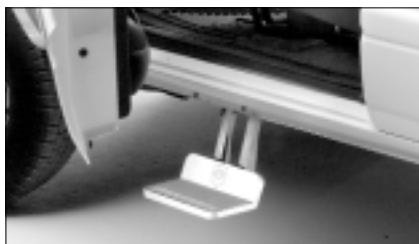
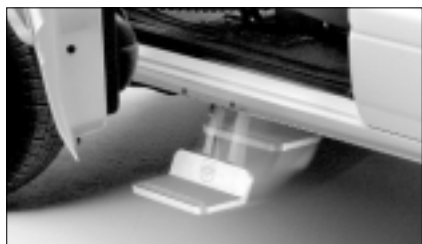

NEW

MOPAR FEATURES	COMPETITORS?*
<ul style="list-style-type: none"> • Features premium heavy-duty hardware and solid state circuitry • Bright cast aluminum tread features a deep slip resistant surface • Mounts securely to vehicle and safely supports up to 350 lbs • Automatically lowers when the door is opened and retracts when the door is closed for maximum ground clearance • Safety clutch stops the step movement up or down if it encounters obstacles or resistance • Mopar Accessories are covered by either the 3-year/36,000-mile New Vehicle Limited Warranty or the 12-month/12,000-mile Mopar Basic Limited Warranty, whichever is more favorable to the customer 	<ul style="list-style-type: none"> • Is it constructed of premium heavy-duty hardware and solid state circuitry? • Does it have a slip resistant surface? • Can it support up to 350 lbs? • Does it automatically lower when the door opens and retract when the door is closed? • Does it have a safety feature that will stop the movement up or down if it encounters obstacles or resistance? • Does the warranty compare?

*Check your market for your competitive situation.

INSTALLATION:

- Some tools required
- Some drilling required
- Some wiring required

Vehicle Line	MYO MYI	Application Remarks	Part Number	Instl Time	Group	Sugg Retail Price
SIDE STEPS, POWER STEP, TRUCK						
Ram Pickup (All)	2001 1998	Powered Side Step, electric	82206086	2.0	T	TBD

SIDE STEPS, TUBULAR, TRUCK



Side Step in brushed aluminum (shown on Ram Pickup)



Quad Cab™ w/Step Pad (shown on Ram Pickup)



Chrome Side Step (shown on Dakota)

MOPAR FEATURES	COMPETITORS?*
<ul style="list-style-type: none"> • Anodized aluminum resists corrosion, pitting, peeling, and is scratch-resistant • E-coat primer and powder-coat paint provide a durable finish on color steps • Mopar uses stainless steel fasteners and hardware • Provide easy entry into the vehicle • Integrated TPO Step Pad • Mandrel tubing bends for a full, round appearance • Wide Step Pad provides for easy entry and secure footing • Mopar Accessories are covered by either the 3-year/36,000-mile New Vehicle Limited Warranty or the 12-month/12,000-mile Mopar Basic Limited Warranty, whichever is more favorable to the customer 	<ul style="list-style-type: none"> • Is it anodized aluminum? Will it pit or corrode? • Does it have an E-coat/powder-coat finish, or an enamel finish, which may chip, scratch and rust easily? • Are plain steel fasteners used, which may rust? Is all hardware stainless steel? • Is the tubing round? Does it have a thinner diameter? • Does it have a skid-resistant surface? • How wide is the stepping surface? Is it a tube or pad surface? • Does the warranty compare?

*Check your market for your competitive situation.

Vehicle Line	MYO	MYI	Application Remarks	Part Number	Instl Time	Group	Sugg Retail Price
SIDE STEPS, TUBULAR — DAKOTA							
Dakota Club Cab	2001	1997	Black steel, Club Cab, metal Step Pad	82202737	1.0	T	435.00
	2001	1997	Black aluminum, Club Cab, metal Step Pad	82202736	1.0	T	460.00
	2001	1997	Silver aluminum, Club Cab, metal Step Pad	82202738	1.0	T	460.00
	2001	1997	Chrome, Club Cab, metal Step Pad	82203074	1.0	T	625.00
Dakota Quad Cab	2001	2000	Black Steel, Quad Cab, plastic Step Pad	82205063	1.0	T	460.00
	2001	2000	Silver aluminum, Quad Cab, plastic Step Pad	82205065	1.0	T	460.00
	2001	2000	Chrome, Quad Cab, plastic Step Pad	82205066	1.0	T	650.00
Dakota Regular Cab	2001	1997	Black Steel, Regular Cab, metal Step Pad	82202734	1.0	T	380.00
	2000	1997	Flame Red, Regular Cab, metal Step Pad	82203079	1.0	T	390.00
	2001	1997	Black aluminum, Regular Cab, metal Step Pad	82202733	1.0	T	420.00
	2001	1997	Silver aluminum, Regular Cab, metal Step Pad	82202735	1.0	T	420.00
	2001	1997	Chrome, Regular Cab, metal Step Pad	82203073	1.0	T	550.00

SIDE STEPS, TUBULAR, TRUCK (CONT.)

Vehicle Line	MY0	MY1	Application Remarks	Part Number	Instl Time	Group	Sugg Retail Price
SIDE STEPS, TUBULAR — RAM PICKUP							
Ram Pickup - Club or Quad Cab	2001	1998	Black steel, Quad or Club Cab, plastic Step Pad	82203927	1.0	T	390.00
	2001	1998	Black aluminum, Quad or Club Cab, plastic Step Pad	82203928	1.0	T	425.00
	2001	1998	Silver aluminum, Quad or Club Cab, plastic Step Pad	82203929	1.0	T	425.00
	2001	1998	Chrome, Quad or Club Cab, plastic Step Pad	82203930	1.0	T	575.00
Ram Pickup - Regular Cab (All)	2001	1994	Black steel, Regular Cab, metal Step Pad	82401295	1.0	T	340.00
	2001	1994	Black aluminum, Regular Cab, metal Step Pad	82401294	1.0	T	375.00
	2001	1994	Silver aluminum, Regular Cab, metal Step Pad	82401293	1.0	T	375.00
	2001	1995	Chrome Steel, Regular Cab, metal Step Pad	82202693	1.0	T	500.00
SIDE STEPS, TUBULAR, BODY COLOR — DURANGO							
Durango	2000	1998	Installation Kit — Required to install Tubular Side Steps packaged prior to 7/26/1999 on vehicles equipped with Rear Air Conditioning	82205793	0.5	T	13.00
	2000	1998	Dark Chestnut	82203830	1.0	T	425.00
	2000	1998	Deep Amethyst (PCN)	82203828	1.0	T	425.00
	2000	1998	Intense Blue (PB3)	82203829	1.0	T	425.00
	2000	1998	Light Driftwood (PFK)	82203826	1.0	T	425.00
	2001	1998	Bright White (PW7)	82206963	1.0	T	435.00
	2001	1998	Chili Pepper Red (PEA)	82206966	1.0	T	435.00
	2001	1998	Black (PX8)	82206362	1.0	T	425.00
	2001	1998	Flame Red (PR5)	82206964	1.0	T	435.00
	2001	1998	Forest Green (PG8)	82206965	1.0	T	435.00
	2001	1999	Patriot Blue (WB7)	82206967	1.0	T	TBD
	2001	1999	Bright Silver Metallic (WS2)	82206968	1.0	T	TBD
	2001	2001	Light Pewter Metallic	82206545	1.0	T	435.00
	2001	2001	Dark Garnet Red (QRV)	82206546	1.0	T	435.00
	2001	2001	Medium Bronze (QTL)	82206544	1.0	T	435.00
	2001	1998	Silver Aluminum	82205795	1.0	T	435.00
	2001	2001	Silver aluminum, w/separate step pads	82206361	1.0	T	435.00
	2000	1998	Chrome	82205794	1.0	T	560.00
	2001	2001	Chrome steel, w/separate step pads	82206360	1.0	T	560.00
	2001	2001	Black steel, w/separate step pads	82206362	1.0	T	435.00

SKID PLATES



Steering Box Skid Plate (shown on Wrangler)



Oil Pan Skid Plate

MOPAR FEATURES	COMPETITORS?*
<ul style="list-style-type: none"> • Add extra protection area during off-road use • Made from heavy-gauge steel and painted with a high-quality black electrocoat finish • Mopar Accessories are covered by either the 3-year/36,000-mile New Vehicle Limited Warranty, or the 12-month/12,000-mile Mopar Basic Limited Warranty, whichever is more favorable to the customer 	<ul style="list-style-type: none"> • Does it add extra protection during off-road use? • How is it designed? • Does the warranty compare?

*Check your market for your competitive situation.

INSTALLATION:

- No drilling required
- Uses existing hardware
- 4WD only

SKID PLATES (CONT.)

Vehicle Line	MYO	MYI	Application Remarks	Part Number	Instl Time	Group	Sugg Retail Price
SKID PLATES							
Cherokee	2001	1999	Transfer Case, same as found in OE Skid Plate Group	82205147	0.5	T	35.00
	2001	1997	Front suspension, same as found in OE Skid Plate Group	82202851	0.5	T	69.00
	2001	1997	Fuel Tank, same as found in OE Skid Plate Group	82203726	1.0	T	134.00
Dakota (All)	2001	2000	Transfer Case	82205937	0.5	T	48.00
	2001	2000	Front Suspension	82205936	0.5	T	115.00
Dakota 4x4 - Regular & Club Cab	2001	1997	Fuel Tank	82203839	1.0	T	85.00
Durango	2001	2000	Transfer Case	82205937	0.5	T	48.00
	2001	2000	Front Suspension	82205936	0.5	T	115.00
Grand Cherokee	2001	1999	Fuel Tank - Same as found in OE Skid Plate Group	52100376AE	1.0	T	133.00
	2001	1999	Transfer case, same as found in OE Skid Plate Group	82204489	0.5	T	38.00
	2001	1999	Front suspension, same as found in OE Skid Plate Group	82204488	0.4	T	46.00
Ram Pickup 4x4	2001	1996	Transfer Case	82203787	0.5	T	39.75
Wrangler	2000	1997	Oil and Transmission pans, 2.5 L, 4 Cylinder	82206335	0.6	T	88.00
	2000	1997	Oil and Transmission pans, 4.0L, 6 cylinder	82206334	0.6	T	88.00
	2000	1997	Oil Pan, 2.5L, HD 3/16" Steel Skid Plate adds protection beyond OE Skid Plate Group	82202690*	0.6	T	88.00
	2000	1997	Oil Pan, 4.0L, HD 3/16" steel Skid Plate adds protection beyond OE Skid Plate Group	82202538*	0.6	T	88.00
	2001	1998	Steering Gear, HD 1/8" steel treadplate adds protection beyond OE Skid Plate Group	82204732	0.4	T	103.00
	2000	1998	Fuel Tank, HD 3/16" steel treadplate adds protection beyond OE Skid Plate Group	82204731	0.8	T	315.00

*Use existing hardware (in some applications, two [2] M8x25mm long bolts with lockwashers and nuts are required to attach Skid Plate to transmission support.

SMOKER'S PACKAGE



Smoker's Package (Minivan)

MOPAR FEATURES	COMPETITORS?*
<ul style="list-style-type: none"> • Includes lighter element, one front ashtray and two rear flip-top ashtrays • Fits in front storage compartment • Color coordinated to match vehicle interior • Mopar Accessories are covered by either the 3-year/36,000-mile New Vehicle Limited Warranty, or the 12-month/12,000-mile Mopar Basic Limited Warranty, whichever is more favorable to the customer 	<ul style="list-style-type: none"> • Does the warranty compare?

*Check your market for your competitive situation.

INSTALLATION:

Easily installed

Vehicle Line	MYO	MYI	Application Remarks	Part Number	Instl Time	Group	Sugg Retail Price
SMOKER'S PACKAGE							
Avenger, Sebring Coupe	2000	1995	Smoker's Package, includes ash receiver and lighter - Woodgrain	82300972	D.I.Y.	T	20.00
Breeze, Cirrus, Stratus, Neon, PT Cruiser	2001	1997	Smoker's Package, includes ash receiver and lighter	04595823AA	D.I.Y.	T	20.00
Minivan (All)	2001	2001	Smoker's Package, Taupe, includes ash receiver and lighter	82206453	D.I.Y.	T	26.00
	2001	2001	Smoker's Package, Navy Blue, includes ash receiver and lighter	82206454	D.I.Y.	T	26.00
	2001	2001	Smoker's Package, Sandstone, includes ash receiver and lighter	82206455	D.I.Y.	T	26.00
Stratus Sedan, Sebring Sedan	2001	2001	Smoker's Package, includes ash receiver and lighter	04598533AA	D.I.Y.	T	20.00

SNOW PLOWS, FRONT AIR SHOCK KIT

Vehicle Line	MYO	MYI	Application Remarks	Part Number	Instl Time	Group	Sugg Retail Price
SNOW PLOWS — FRONT AIR SHOCK KIT							
Cherokee SE 4WD	2000	1994	Front Air Shocks for Cherokee to support the weight of a Snow Plow.	82202826	1.2	T	100.00
Wrangler	2001	1997	Air Shock Kit - Front Suspension	82202562	1.2	T	100.00

SPARE TIRE LOCKS



Spare Tire Locks

MOPAR FEATURES	COMPETITORS?*
<ul style="list-style-type: none"> • Protect against spare wheel and tire theft • Special key allows only the owner to lower or raise spare tire • Easy to use • Mopar Accessories are covered by either the 3-year/36,000-mile New Vehicle Limited Warranty or the 12-month/12,000-mile Mopar Basic Limited Warranty, whichever is more favorable to the customer 	<ul style="list-style-type: none"> • Does it have added security? • How easy is it to use? • Does the warranty compare?

*Check your market for your competitive situation.

INSTALLATION:

Simply remove/replace spare tire guide tube with Mopar Spare Tire Lock

Vehicle Line	MYO	MYI	Application Remarks	Part Number	Instl Time	Group	Sugg Retail Price
SPARE TIRE LOCK KITS							
Dakota (All)	2001	1997	5.3 ft. or 6.5 ft. bed, exclusive Mopar key patterns	82203352	0.4	T	30.00
Ram Pickup w/6.5 Ft. Bed	2001	1998	6.5 ft. bed, exclusive Mopar key patterns	82204363	0.4	T	30.00
Ram Pickup w/8.0 Ft. Bed	2001	1998	8.0 ft. bed, exclusive Mopar key patterns	82204364	0.4	T	30.00

SPEED CONTROL



Speed Control (shown on Ram)



Dakota



Minivan

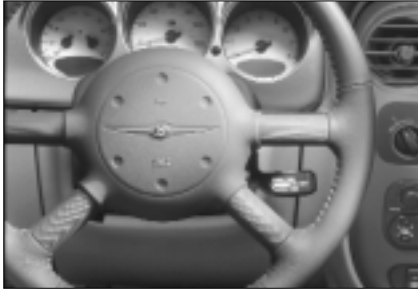

Chrysler

MOPAR FEATURES	COMPETITORS?*
<ul style="list-style-type: none"> • Same as OE available only through Mopar • Features include convenient resume, acceleration, set and deceleration controls • OE wiring or custom fit overlay wiring harness with OE connectors • Mopar Accessories are covered by either the 3-year/36,000-mile New Vehicle Limited Warranty or the 12-month/12,000-mile Mopar Basic Limited Warranty, whichever is more favorable to the customer 	<ul style="list-style-type: none"> • OE components only available through Mopar • Does the warranty compare?

*Check your market for your competitive situation.

SPEED CONTROL (CONT.)

Vehicle Line	MYO	MYI	Application Remarks	Part Number	Instl Time	Group	Sugg Retail Price
SPEED CONTROL KITS							
Cherokee	2001	1999	All engines, complete kit	82204703	0.9	3	235.00
Dakota, Durango	2000	2000	3.9L V6	82205670	1.1	3	235.00
	2000	2000	4.7L V8	82205855	1.1	3	235.00
	2000	2000	5.2L and 5.9L V8	82205856	1.1	3	235.00
	2001	2001	3.9L V6	82206969	1.1	3	235.00
	2001	2001	4.7L V8	82206970	1.1	3	235.00
	2001	2001	5.2L and 5.9L V8	82206971	1.1	3	235.00
Minivan (All)	2000	1998	2.4 Liter, Complete Kit	82205939	1.2	3	225.00
	2000	1997	3.0 Liter, Complete Kit	82204649	1.2	3	225.00
	2000	1997	3.3 Liter, Complete Kit	82204650	1.2	3	225.00
	2001	2001	3.3 Liter, Complete kit	82206346*	1.2	3	235.00
Minivan (SWB Only)	2001	2001	2.4 Liter, Complete Kit	82206343*	1.2	3	235.00
Neon	2001	2001	Complete Kit, all engines Slate Grey Switches	82206834	1.2	3	210.00
PT Cruiser	2001	2001	Complete kit, all engine/transmission	82205444	1.2	3	200.00
Ram Pickup (All)	2001	1999	All diesel engines, complete kit, for Ram Pickups built after June 8, 1998, also order clockspring (56045455AB)	82204654 [†]	1.2	3	235.00
	2001	1999	All V10 engines, complete kit, for Ram Pickups built after June 8, 1998, also order clockspring (56045455AB)	82204651 [†]	1.2	3	235.00
	2001	1999	All V6 and V8 engines, complete kit, for Ram Pickups built after June 8, 1998, also order clockspring (56045455AB)	82204652	0.8	3	235.00
Ram Van/Wagon	2001	2000	All engines, complete kit	82206980	1.0	3	235.00
	2000	1999	All engines, complete kit	82204705	1.0	3	235.00
Wrangler	2000	1999	All engines, complete kit	82204704	1.2	3	235.00
	2001	2001	All engines, complete kit	82206977	1.2	3	235.00

*Available 01/01/01.

[†]For Ram Pickups built after 06/08/80, also order clockspring (56045455AB).

SPLASH GUARDS, DELUXE ANTISPRAY



Antispray Splash Guard

MOPAR FEATURES	COMPETITORS?*
<ul style="list-style-type: none"> • Black Jeep® and Dodge logo on all four splash guards • Predrilled holes for easy installation • Ultra rubber antispray construction provides a design to channel water downward, effectively reducing road spray on vehicle • Authentic Jeep or Dodge design products are designed by the creators of the vehicle • Mopar Accessories are covered by either the 3-year/36,000-mile New Vehicle Limited Warranty, or the 12-month/12,000-mile Mopar Basic Limited Warranty, whichever is more favorable to the customer 	<ul style="list-style-type: none"> • Jeep and Dodge logos are exclusive to DaimlerChrysler Corporation, Jeep, Dodge and Mopar • Is drilling through the Splash Guards required, which may cause alignment difficulty? • Is it thinner “passenger car-style” material? • Mopar Accessories are the only genuine Jeep or Dodge vehicle-designed products available for the vehicle • Does the warranty compare?

*Check your market for your competitive situation.

INSTALLATION:

Predrilled guards allow for easy alignment and installation

Vehicle Line	MY0	MY1	Application Remarks	Part Number	Instl Time	Group	Sugg Retail Price
SPLASH GUARDS — DELUXE ANTI-SPRAY							
Cherokee	2001	1997	Front, w/Black Jeep logo, except w/Running Boards	82203434	0.3	T	31.00
	2001	1997	Rear, w/Black Jeep logo	82203435	0.5	T	31.00
Ram 2500/3500 Regular Cab 4x4	2001	1994	Black, rear, except dual wheels, w/Black logo, 4WD, Maxi (3" longer)	82401335	0.5	T	31.00
Ram 3500 Pickup	2000	1994	Black, rear, dual wheels, w/Black logo	82203036	0.5	T	38.00
Ram Pickup - Regular Cab 4x4	2001	1994	Black, front, w/Black logo, 4WD	82401227*	0.3	T	23.00
	2001	1994	Black, rear, except dual wheels, w/Black logo, 4WD	82401228	0.5	T	23.00
	2001	1994	Black, front, w/Black logo, 4WD, Maxi (3" longer)	82401334*	0.3	T	31.00

*Front end guards cannot be used with Side Steps or Running Boards.

SPLASH GUARDS, DELUXE MOLDED



Molded Splash Guards for 4WD pickups
(shown on Ram Pickup)



Molded Splash Guards for 2WD pickups
(shown on Ram Pickup)



Dakota



Durango



Voyager



Sebring

MOPAR FEATURES

- Molded to the contours of the vehicle, custom fit to body panel
- Provide superior protection against mud, gravel, salt and other road debris
- Packaged in pairs
- Can be used for front or rear application
- Thermoplastic Olefin (TPO) construction provides outstanding toughness and flexibility even in extreme temperatures
- Thermoplastic rubber (TPR) construction provides outstanding toughness and flexibility even in extreme temperatures
- Dedicated mounting hardware matches wheelhouse contour
- Pre-drilled holes for easy installation
- Wax-tipped black screws and plastic inserts help prevent rust
- Mopar Accessories are covered by either the 3-year/36,000-mile New Vehicle Limited Warranty or the 12-month/12,000-mile Mopar Basic Limited Warranty, whichever is more favorable to the customer

COMPETITORS?*

- Do they have a universal design? Are there gaps between the guard and the body?
- Are they made of a more rigid plastic, which may break in cold weather?
- Is the hardware universal, making installation more difficult?
- Is drilling through the Splash Guards required, which may cause alignment difficulty?
- Do they use untreated screws, which may promote rust?
- Does the warranty compare?

*Check your market for your competitive situation.

INSTALLATION:

- Pre-drilled molded guards allow for easy alignment and installation
- Uses existing body holes — no drilling
- Easy alignment and installation
- Packaged in pairs

SPLASH GUARDS, DELUXE MOLDED (CONT.)

Vehicle Line	MYO	MYI	Application Remarks	Part Number	Instl Time	Group	Sugg Retail Price
SPLASH GUARDS — DELUXE MOLDED							
300M	2001	1998	Black, rear, pair	82203658	0.5	T	26.00
	2001	1998	Black, front, pair	82203657	0.5	T	26.00
Breeze, Cirrus, Stratus	2000	1995	Black, rear, pair	82300796	0.5	T	24.00
	2000	1995	Black, front, pair	82300795	0.5	T	24.00
Cherokee	2001	1997	Black, front	82202717*	0.3	T	38.00
	2001	1997	Black, rear, w/Jeep logo	82202718*	0.5	T	38.00
Concorde LX	2001	1998	Black, front, pair	82203655	0.5	T	24.00
	2001	1998	Black, rear, pair	82203656	0.5	T	26.00
Concorde LXi	2001	1998	Black, rear, pair	82203656	0.5	T	26.00
Dakota Quad Cab	2001	1997	Black, front or rear except rear Quad Cab, w/Ram's Head logo, use w/wheel flares	82203473*	0.3	T	38.00
	2001	1997	Black, front or rear, w/Ram's Head logo, use w/o wheel flares	82202719*	0.5	T	38.00
	2001	2000	Black, rear, w/Ram's Head logo, use w/wheel flares	82204879*	0.3	T	38.00
Dakota Regular & Club Cab	2001	1997	Black, rear, w/Ram's Head logo, use w/o wheel flares	82203619	0.3	T	38.00
	2001	1997	Black, front or rear, w/Ram's Head logo, use w/wheel flares	82203473*	0.3	T	38.00
	2001	1997	Black, front or rear and rear, w/Ram's Head logo, use w/o wheel flares	82202719*	0.5	T	38.00
Durango	2001	1998	Black, front or rear, w/Ram's Head logo, use w/o wheel flares	82202719	0.5	T	38.00
	2001	1998	Black, front or rear, w/Ram's Head logo, use w/wheel flares	82203473	0.3	T	38.00
	2001	1998	Black, rear, w/Ram's Head logo	82203618	0.3	T	38.00
Grand Caravan (All)	2001	2001	Splash Guards, Molded rear, Black, long wheelbase	82206552	0.4	T	33.00
Grand Cherokee	2001	1999	Driftwood, rear, Laredo	82204529	0.3	T	38.00
	2001	1999	Driftwood, front, Laredo	82204530 ¹	0.3	T	38.00
	2001	1999	Driftwood, front, Laredo, use w/o running boards	82204530 ¹	0.3	T	38.00
	2001	2000	Dark Gray, rear, Laredo	82205790	0.3	T	38.00
	2001	2000	Dark Gray, front, Laredo, use w/running boards	82205789*	0.3	T	38.00
	2001	2001	Dark Blue Metallic (YBM), Rear, for Laredo	82206766	0.3	T	38.00
	2001	2001	Dark Blue Metallic (YBM), Front, for Laredo, w/o wheel flares	82206764*	0.3	T	38.00
	2001	2001	Dark Garnet Red Metallic (YR8), Rear, for Laredo	82206767	0.3	T	38.00
	2001	2001	Dark Garnet Red Metallic (YR8), Front, for Laredo, use w/o wheel flares	82206765*	0.3	T	38.00
	2001	1999	Black, rear, paintable, Limited, use w/o running boards	82204354	0.3	T	38.00
2001	1999	Black, front, paintable, Limited — use w/o running boards	82204353 ¹	0.3	T	38.00	
Intrepid	2001	1998	Black, rear, pair	82203660	0.5	T	26.00
	2001	1998	Black, front, pair	82203659	0.5	T	26.00
LHS	2001	1998	Black, rear, pair	82203656	0.5	T	26.00
	2001	1998	Black, rear, pair	82204522	0.5	T	26.00
	2001	1998	Black, front, pair	82204521	0.5	T	26.00
Minivan (LWB Only)	2000	1996	Black, rear, w/o cladding	82300871	0.4	T	24.00

*Vehicles with Mopar Cladding/Running Boards order PN 82204681.

¹Front end guards cannot be used with Side Steps or Running Boards.

SPLASH GUARDS, DELUXE MOLDED (CONT.)

Vehicle Line	MYO	MYI		Application Remarks	Part Number	Instl Time	Group	Sugg Retail Price
SPLASH GUARDS — DELUXE MOLDED (CONT.)								
Minivan (SWB Only)	2000	1996	1275	Black, rear, w/o cladding	82202578	0.4	T	24.00
	2001	2001	2300	Black, rear, short wheelbase	82206551	0.4	T	33.00
Neon	2001	2000	1700	Black, rear w/ Neon logo	82204550	0.3	T	24.00
Prowler	2001	1997		Black, front pair	82203235	0.4	T	32.00
	2001	1997		Black, rear pair	82203236	0.5	T	32.00
Ram Pickup — Regular Cab 4x4	2000	1994	2500	Black, front or rear, 4WD, use w/o side steps or running boards	82205092*	0.5	T	36.00
Ram Pickup 4x2	2001	1994	2600	Black, front or rear, 2WD, except dual wheels, use w/o side steps or running boards,	82401291*	0.3	T	38.00
Ram Pickup 4x4	2001	1994	2600	Black, front or rear, 4WD, except dual wheels use w/o side steps or running boards	82205854*	0.5	T	38.00
Sebring Convertible	2000	1996	1700	Black, rear	82202053	0.5	T	24.00
	2001	2001	1800	Black, rear	82206459	0.5	T	26.00
Sebring Coupe	2001	2001	2300	Black, rear, molded w/Sebring logo	82206482	0.5	T	33.00
Stratus Coupe	2001	2001	2300	Black, rear w/Stratus logo	82206483	0.5	T	33.00
Stratus SE (Sedan)	2001	2001		Black, rear	82206700	0.5	T	26.00
Voyager & Grand Voyager — Base or SE, Caravan & Grand Caravan — Base or SE or Sport	2000	1996	1275	Black, front, w/o cladding	82300870	0.4	T	24.00
Wrangler	2001	1997	2600	Black, front	82202306	0.3	T	38.00
	2001	1997	2600	Black, rear, w/logo	82202307	0.5	T	38.00

*Front end guards cannot be used with Side Steps or Running Boards.

SPLASH GUARDS, DIAMOND PLATE



Diamond Plate Splash Guard
(shown on Ram Pickup)

MOPAR FEATURES	COMPETITORS?*
<ul style="list-style-type: none"> • Flat, rugged all-weather design • Hot stamped Black Dodge logo adds a custom touch • Predrilled holes for easy installation • Mopar Accessories are covered by either the 3-year/36,000-mile New Vehicle Limited Warranty or the 12-month/12,000-mile Mopar Basic Limited Warranty, whichever is more favorable to the customer 	<ul style="list-style-type: none"> • Does it have a flat surface behind splash guard? • Dodge logo is exclusive to DaimlerChrysler Corporation, Dodge and Mopar • Is drilling through the splash guards required, which may cause alignment difficulty? • Does the warranty compare?

*Check your market for your competitive situation.

INSTALLATION:

Predrilled guards allow for easy alignment and installation

Vehicle Line	MYO	MYI	Application Remarks	Part Number	Instl Time	Group	Sugg Retail Price
SPLASH GUARDS — DIAMOND PLATE							
Ram 3500 Pickup	2000	1994	Rear Splash Guards, 3500 Models (Dual Rear wheel)	82401360	0.2	T	112.00
	2001	2001	Rear Splash Guards, 3500 Models (Dual Rear wheel)	82206397	0.2	T	115.00
Ram Pickup 4x2	2001	1994	Rear Splash Guards, 2WD, 1500 & 2500 Models	82401359	0.2	T	56.00
Ram Pickup 4x4	2001	1994	Rear Splash Guards, 4WD, 1500 & 2500 Models (not for 3500 models)	82401358	0.2	T	75.00

SPLASH GUARDS, HD RUBBER



Rubber Splash Guards (shown on Wrangler)



Predrilled for easy installation, front



Custom brackets for easy installation, rear

MOPAR FEATURES

- Vehicle logo on all four Splash Guards adds personal touch
- Predrilled custom brackets for easy installation; no drilling required
- Extra-thick rubber for durability and long use; rugged, all-weather design; unique design minimizes road spray on vehicle
- Constructed of a blend of polyethylene rubber and selected ethyl vinyl acetate to provide outstanding toughness even in extreme temperatures
- Packaged in pairs
- Wax-tipped screws resist rust
- Hardware included
- Mopar Accessories are covered by either the 3-year/36,000-mile New Vehicle Limited Warranty, or the 12-month/12,000-mile Mopar Basic Limited Warranty, whichever is more favorable to the customer

COMPETITORS?*

- Vehicle logo is exclusive to DaimlerChrysler Corporation, Jeep, Dodge and Mopar
- Is drilling through the splash guards required, which may cause alignment difficulty?
- Is it thinner "passenger car-style" material?
- Does the warranty compare?

*Check your market for your competitive situation.

INSTALLATION:

- Predrilled guards allow for easy alignment and installation
- No drilling required

Vehicle Line	MYO	MYI	Application Remarks	Part Number	Instl Time	Group	Sugg Retail Price
SPLASH GUARDS — HD RUBBER							
Dakota 4x2	2001	1997	Front or rear, pair, w/Dodge logo, 2 WD	82202909	0.3	T	32.00
Dakota 4x4	2001	1997	Front or rear, pair, w/Dodge logo, 4WD	82202910	0.3	T	32.00
Durango 4x2	2001	1998	Front or rear, pair, w/Dodge logo, 2 WD	82202909	0.3	T	32.00
Durango 4x4	2001	1998	Front or rear, pair, w/Dodge logo, 4WD	82202910	0.3	T	32.00
	2001	1998	Rear, pair, w/Dodge logo, 4WD	82204073	0.3	T	32.00
Ram 3500 Pickup	2000	1994	Rear, pair, w/Ram Head logo, for use with dual rear wheels	82204506	0.3	T	32.75
	2001	2000	Rear, pair, w/Dodge logo, for use with dual rear wheels	82205925	0.3	T	35.00
Wrangler	2001	1997	Front w/ Jeep logo	82202304	0.3	T	23.00
	2001	1997	Rear, w/ Jeep logo	82202305	0.5	T	31.00

SPLASH GUARDS, MOLDED FLAT



Voyager



Caravan



Intrepid



Sebring



Stratus



300M



Ram's Head

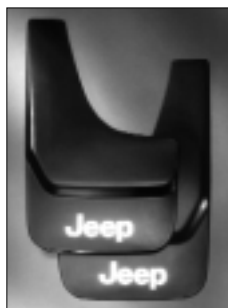

Jeep Flat Splash Guards



Neon



PT Cruiser

MOPAR FEATURES

- Hot-stamped silver vehicle logo adds a personal touch
- High-quality construction resists cracking and flexing
- Constructed of a blend of polyethylene rubber and selected ethyl vinyl acetate to provide outstanding toughness even in extreme temperatures
- Provide superior protection against mud, gravel, salt and road debris
- Wax-tipped screws resist rust
- Mopar Accessories are covered by either the 3-year/36,000-mile New Vehicle Limited Warranty, or the 12-month/12,000-mile Mopar Basic Limited Warranty, whichever is more favorable to the customer

COMPETITORS?*

- Logos are exclusive to DaimlerChrysler Corporation and Mopar
- Are they made of high-quality materials, or of a cheaper material that may crack or deform under temperature extremes?
- Do they use untreated screws, which may promote rust?
- Does the warranty compare?

*Check your market for your competitive situation.

INSTALLATION:

- Easy alignment and installation
- Packaged in pairs (front or rear)

SPLASH GUARDS, MOLDED FLAT

Vehicle Line	MY0	MY1	Application Remarks	Part Number	Instl Time	Group	Sugg Retail Price
SPLASH GUARDS — MOLDED FLAT							
300M	2001	1998	Black, rear, 300M logo, size 2	82204531*	0.5	T	12.00
Avenger	2000	1995	Black, rear, Avenger logo, size 2	82203870*	0.5	T	10.50
Avenger, Sebring Coupe, Breeze, Cirrus, Stratus, Sebring Convertible, Concorde, Intrepid, LHS, 300M, Neon, PT Cruiser	2001	1993	Black, front, no logo, size 1	82203875*	0.3	T	10.50
	2001	1993	Black, front or rear, no logo, size 2	82203876*	0.5	T	12.00
Breeze	2000	1995	Black, rear, Breeze logo, size 2	82203869*	0.5	T	10.50
	2000	1996	Black, w/silver logo, set of 4	82202274*	1.0	T	14.50
Breeze, Plymouth Neon	2001	1995	Black, front or rear, Plymouth logo, size 2	82203864*	0.5	T	10.50
Breeze, Cirrus, Stratus	2000	1995	Black, w/silver logo, set of 4	82300794*	1.0	T	14.50
Caravan, Grand Caravan (FWD & AWD), Caravan, Grand Caravan (FWD & AWD)	2001	1996	Black, rear, Caravan logo, size 2	82203873	0.5	T	12.00
Cherokee	2001	1984	Black, front or rear, Jeep logo, size 3	82203703	0.5	T	13.00
Cherokee, Grand Cherokee, Wrangler	2001	1960	Black, front or rear, no logo, size 3	82203706	0.3	T	13.00
	2001	1960	Black, front or rear, no logo, size 4	82203707	0.3	T	13.00
Cirrus LXi	2000	1995	Black, rear, size 2	82203867*	0.5	T	10.50
	2000	1995	Black, w/Silver logo, set of 4	82300793*	1.0	T	14.50
Concorde, LHS	2001	1993	Black, rear, Concorde logo, size 2	82203651	0.5	T	12.00
Dakota 4x2	2001	1986	Black, front or rear, Rams Head logo, 2WD standard tire pkg, size 3	82203704*	0.3	T	13.00
	2000	1997	Front or rear set of 2, 2WD, w/Dodge logo	82202911*	0.3	T	20.00
Dakota 4x4	2001	1997	Front or rear set of 2, w/Dodge logo, 4WD	82202912*	0.3	T	20.00
Durango 4x2	2001	1998	Black, front or rear, Rams Head logo, 2WD standard tire pkg, size 3	82203704*	0.3	T	13.00
Durango 4x4, Ram Pickup	2001	1994	Black, front or rear, Rams Head logo, 4WD or wide tire package, size 4	82203705*	0.3	T	13.00
Durango, Ram Pickup	2001	1960	Black, front or rear, no logo, size 3	82203706	0.3	T	13.00
	2001	1960	Black, front or rear, no logo, size 4	82203707	0.3	T	13.00
Grand Caravan AWD, Caravan, Grand Caravan (FWD & AWD)	2001	1996	Black, front or rear, Dodge logo, size 2	82203865	0.3	T	12.00

*Not recommended for use with Ground Effects Package.

SPLASH GUARDS, MOLDED FLAT (CONT.)

Vehicle Line	MYO	MYI	Application Remarks	Part Number	Instl Time	Group	Sugg Retail Price
SPLASH GUARDS — MOLDED FLAT (CONT.)							
Intrepid	2001	1993	Black, rear, Intrepid logo, size 2	82203654*	0.5	T	12.00
LHS	2001	1993	Black, rear, LHS logo, size 2	82203652*	0.5	T	12.00
Minivan (All)	2000	1996	Black, front, no logo, size 1	82203875	0.3	T	10.50
	2001	1996	Black, front or rear, no logo, size 2	82203876*	0.5	T	12.00
	2001	1960	Black, front or rear, no logo, size 3	82203706*	0.3	T	13.00
	2001	1960	Black, front or rear, no logo, size 4	82203707*	0.3	T	13.00
Neon	2001	2000	Black, front or rear, Neon logo, size 1	82204549*	0.3	T	12.00
Passenger Cars (All)	2001	1960	Black, front or rear, no logo, size 3	82203706*	0.3	T	13.00
	2001	1960	Black, front or rear, no logo, size 4	82203707*	0.3	T	13.00
PT Cruiser	2001	2001	Black, rear, pair, PT Cruiser logo	82205781*	0.5	T	24.00
	2001	2001	Black, rear, PT Cruiser logo, size 2	82205453*	0.5	T	12.00
Ram 3500 Pickup	2001	2001	Black, rear, dual wheels, w/black logo	82206392	0.5	T	42.00
Ram Van/Wagon, Dakota (All)	2001	1960	Black, front or rear, no logo, size 3	82203706*	0.3	T	13.00
	2001	1960	Black, front or rear, no logo, size 4	82203707*	0.3	T	13.00
Ram Van/Wagon, Dakota 4x4	2001	1971	Black, front or rear, Rams Head logo, 4WD or wide tire package, size 4	82203705*	0.3	T	13.00
Sebring Convertible	2000	1996	Black, front or rear w/ Sebring logo	82202339*	0.5	T	9.30
Sebring Coupe	2000	1995	Black, rear, Sebring logo, size 2	82203871	0.5	T	10.50
Sebring Coupe, Cirrus LXi, Sebring (Sedan & Conv), Concorde, LHS, Sebring Coupe	2001	1993	Black, front or rear, Chrysler logo, size 2	82203866*	0.5	T	12.00
Sebring Sedan	2001	2001	Black, rear	82206458	0.5	T	26.00
Sebring (Sedan & Conv)	2001	2001	Black, rear, w/Sebring logo, size 2	82206040*	0.5	T	12.00
Stratus, Stratus Sedan	2001	1995	Black, rear, Stratus logo, size 2	82203868	0.5	T	12.00
Stratus, Stratus Sedan, Intrepid, Stratus Coupe	2001	1993	Black, front or rear, Dodge logo, size 2	82203865*	0.3	T	12.00
Town & Country (All)	2001	2001	Black, rear	82206703	0.4	T	33.00
Town & Country AWD, Voyager, Town & Country (FWD & AWD)	2001	1996	Black, front or rear, Chrysler logo, size 2	82203866	0.5	T	12.00
Voyager, Grand Voyager (All FWD)	2000	1996	Black, front or rear, Plymouth logo, size 2	82203864	0.5	T	10.50
	2000	1996	Black, rear, Voyager logo, size 2	82203874	0.5	T	12.00

*Not recommended for use with Ground Effects Package.

SPOILER, REAR



Sebring



Neon



Stratus



Intrepid



Voyager



Concorde



PT Cruiser

MOPAR FEATURES

- Uniquely designed for vehicle by the DaimlerChrysler Corporation Design Team
- Molded from fiberglass-reinforced composite materials, one-piece style
- Meets original equipment paint specifications, using base coat/Clear Coat finish
- Painted to match most body colors
- Tested to ensure it does not flutter or rattle at highway speeds
- Mopar Accessories are covered by either the 3-year/36,000-mile New Vehicle Limited Warranty, or the 12-month/12,000-mile Mopar Basic Limited Warranty, whichever is more favorable to the customer

COMPETITORS?*

- Is it a universal fit? Only Mopar products feature true DaimlerChrysler Corporation design
- Is it cut to fit with add-on end caps, which are easy to misalign?
- Does it have a black finish that requires painting? Will it match?
- Will spoiler rattle or flutter at highway speeds?
- Does the warranty compare?

*Check your market for your competitive situation.

INSTALLATION:

- Simply attaches with four bolts and screws
- Dealer installation recommended

SPOILER, REAR (CONT.)

Vehicle Line	MYO	MYI	Application Remarks	Part Number	Instl Time	Group	Sugg Retail Price
SPOILERS*							
300M	2001	1998	Primed for painting	82204621	0.5	T	185.00
	2001	1998	Champagne (PTE)	82204832	0.5	T	240.00
	2001	1998	Stone White (PW1)	82204828	0.5	T	240.00
	2001	2001	Black (DX8)	82206908	0.5	T	245.00
	2001	2000	Bright Silver (PS2)	82205982	0.5	T	245.00
	2001	2000	Cinnamon Glaze (PLB)	82205983	0.5	T	245.00
	2001	2001	Dark Garnet Red (PRV)	82206909	0.5	T	245.00
	2001	2001	Deep Sapphire Blue	82206910	0.5	T	245.00
	2001	2000	Inferno Red (PEL)	82205984	0.5	T	245.00
	2000	1998	Deep Slate (PAW)	82204830	0.5	T	240.00
Breeze, Cirrus, Stratus	2000	1995	Primed for painting	82203685	0.5	T	215.00
	2000	1995	Stone White (PW1)	82203683	0.5	T	260.00
Concorde, LHS	2001	1998	Primed for painting	82204620	0.5	T	185.00
	2001	1998	Champagne (PTE)	82204824	0.5	T	245.00
	2001	2000	Bright Silver (PS2)	82205993	0.5	T	245.00
	2001	1998	Cinnamon Glaze (PLB)	82204822	0.5	T	245.00
	2001	1998	Stone White (PW1)	82204819	0.5	T	245.00
	2000	1998	Deep Slate (PAW)	82204821	0.5	T	240.00
Intrepid	2001	1998	Primed for painting	82205701	0.5	T	196.00
	2001	2000	Bright Silver (PS2)	82205986	0.5	T	245.00
	2001	1998	Champagne (PTE)	82204082	0.5	T	245.00
	2001	2000	Cinnamon Glaze (PLB)	82205988	0.5	T	245.00
	2001	2000	Dark Garnet Red (PRV)	82205991	0.5	T	245.00
	2001	2000	Inferno Red (PEL)	82205987	0.5	T	245.00
	2001	2000	Shale Green (PGR)	82205989	0.5	T	245.00
	2001	2000	Steel Blue (PBQ)	82205992	0.5	T	245.00
	2001	1998	Stone White (PW1)	82204087	0.5	T	245.00
	2000	1998	Deep Slate (PAW)	82204085	0.5	T	240.00
	2000	2000	Light Cypress Green (PG2)	82205990	0.5	T	240.00
Minivan (All)	2001	2001	Primed for painting	82205923	0.5	T	164.00
	2001	2001	Bright Silver Metallic (WS2)	82206140	0.5	T	215.00
	2001	2001	Champagne Pearl (VTE)	82206137	0.5	T	215.00
	2001	2001	Dark Garnet Red, (XRV)	82206144	0.5	T	215.00
	2001	2001	Inferno Red (WEL)	82206139	0.5	T	215.00
	2001	2001	Patriot Blue Metallic (WB7)	82206138	0.5	T	215.00
	2001	2001	Shale Green Metallic (XGR)	82206142	0.5	T	215.00
	2001	2001	Steel Blue (XBQ)	82206141	0.5	T	215.00
	2001	2001	Stone White (SW1)	82206136	0.5	T	215.00
	2000	1996	Primed for painting	82202961	0.5	T	135.00
	2000	1996	Bright White (PW7)	82202948	0.5	T	175.00
	2000	1998	Deep Cranberry (PMT)	82204342	0.5	T	175.00

*Not for Fleet use.

SPOILER, REAR (CONT.)

Vehicle Line	MYO	MYI	Application Remarks	Part Number	Instl Time	Group	Sugg Retail Price
SPOILERS (CONT.)*							
Neon	2000	2000	Bright Silver (WS2)	82204801	0.5	T	185.00
	2000	2000	Salsa Red (WE5)	82204800	0.5	T	185.00
	2001	2000	Primed for painting — R/T Design	82206285	0.5	T	220.00
	2001	2000	Black (DX8) — R/T Design	82206275	0.5	T	260.00
	2001	2000	Bright Silver Metallic (WS2) — R/T Design	82206281	0.5	T	260.00
	2001	2000	Cinnamon Glaze Metallic (VLB) — R/T Design	82206278	0.5	T	260.00
	2001	2000	Flame Red (PR4) — R/T Design	82206276	0.5	T	260.00
	2001	2000	Garnet Red (XRV) — R/T Design	82206284	0.5	T	260.00
	2001	2000	Patriot Blue (WB7) — R/T Design	82206279	0.5	T	260.00
	2001	2000	Salsa Red (WE5) — R/T Design	82206280	0.5	T	260.00
	2001	2000	Shale Green Metallic (XGR) — R/T Design	82206283	0.5	T	260.00
	2001	2000	Steel Blue (XBQ) — R/T Design	82206282	0.5	T	260.00
	2001	2000	Stone White (SW1) — R/T Design	82206277	0.5	T	260.00
	PT Cruiser	2001	2001	Primed for Painting	82205686	0.5	T
2001		2001	Aquamarine (XQW)	82205695	0.5	T	250.00
2001		2001	Black (DX8)	82205687	0.5	T	250.00
2001		2001	Bright Silver (PS2)	82205693	0.5	T	250.00
2001		2001	Deep Cranberry (PMT)	82205690	0.5	T	250.00
2001		2001	Inferno Red (PEL)	82205692	0.5	T	250.00
2001		2001	Patriot Blue (WB7)	82205691	0.5	T	250.00
2001		2001	Shale Green (PGR)	82205694	0.5	T	250.00
2001		2001	Stone White (PW1)	82205688	0.5	T	250.00
2001		2001	Taupe Frost Metallic (TTK)	82205689	0.5	T	250.00
Sebring Sedan, Stratus Sedan	2001	2001	Primed for painting	82206294	0.5	T	225.00
	2001	2001	Black (DX8)	82206286	0.5	T	295.00
	2001	2001	Bright Silver Metallic (WS2)	82206291	0.5	T	295.00
	2001	2001	Champagne Pearl Coat (PTE)	82206289	0.5	T	295.00
	2001	2001	Deep Sapphire	82206288	0.5	T	295.00
	2001	2001	Inferno Red (PGL)	82206290	0.5	T	295.00
	2001	2001	Shale Green Metallic (DGR)	82206292	0.5	T	295.00
	2001	2001	Stone White (PW1)	82206287	0.5	T	295.00
Viper RT/10	2001	1992	Primed for painting	82204206	0.5	T	440.00
	2001	1992	Viper R/T10 - Viper Red	82204205	0.5	T	550.00

*Not for Fleet use.

STORAGE PRODUCTS, LOCKABLE BOX



Trunk Lockable Storage Box

MOPAR FEATURES	COMPETITORS?*
<ul style="list-style-type: none"> • Mounts wherever needed (parcel tray, trunk floor, rear sidewall) • Heavy 16-gauge steel container • Foam interior padding • Mopar Accessories are covered by either the 3-year/36,000-mile New Vehicle Limited Warranty, or the 12-month/12,000-mile Mopar Basic Limited Warranty, whichever is more favorable to the customer 	<ul style="list-style-type: none"> • Is it a universal mount? • Does the warranty compare?

*Check your market for your competitive situation.

INSTALLATION:

See dealer for installation

Vehicle Line	MYO	MYI	Application Remarks	Part Number	Instl Time	Group	Sugg Retail Price
STORAGE PRODUCTS							
Avenger, Sebring Coupe, Breeze, Cirrus, Stratus, Sebring Convertible, Concorde, Intrepid, LHS, 300M, PT Cruiser, Viper	2001	1992	Cargo area Lockable Storage Box	82205188	0.4	T	96.00
Grand Cherokee	2001	1999	Black, molded, lockable, with adjustable separators, use in rear cargo area	82205010	0.5	T	235.00
Minivan (All)	2000	1996	Cargo area Lockable Storage Box	82205188	0.4	T	96.00
	2000	1996	Lockable Storage Box (mounts under rearmost seat*)	82204618	0.4	T	180.00
Ram Van/Wagon	2001	1993	Cargo area Lockable Storage Box	82205188	0.4	T	96.00

*NOTE: Cannot be installed on rear seats equipped with Underseat Storage Tray. If vehicle is equipped with rear Floor Mats, they must be removed.

STORAGE PRODUCTS, SKI PASS-THROUGH BAG



Ski Pass-Through Bag

MOPAR FEATURES	COMPETITORS?*
<ul style="list-style-type: none"> • Protect interior from snow on skis • Prevents cold air from entering interior through trunk • Mopar Accessories are covered by either the 3-year/36,000-mile New Vehicle Limited Warranty, or the 12-month/12,000-mile Mopar Basic Limited Warranty, whichever is more favorable to the customer 	<ul style="list-style-type: none"> • Does the warranty compare?

*Check your market for your competitive situation.

INSTALLATION:

- No drilling required
- Complete with special fasteners for installation

Vehicle Line	MYO	MYI	Application Remarks	Part Number	Instl Time	Group	Sugg Retail Price
STORAGE PRODUCTS							
Concorde, LHS	2001	1998	Ski Pass-Through Bag	82203636	D.I.Y.	T	52.00

STORAGE PRODUCTS, STORAGE BAG

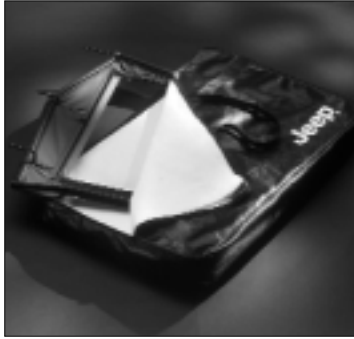

Window Storage Bag
(shown on Wrangler)



Top and bottom mounting brackets secure to tailgate



Handy tool storage

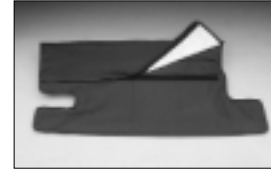

Hook-and-loop closures

MOPAR FEATURES	COMPETITORS?*
<ul style="list-style-type: none"> • Window storage bag custom designed for Wrangler windows • Five compartments • Soft lining minimizes scratching • Vehicle logo adds a custom touch • Ideal for storing small tools • Includes cover that holds contents in place with hook-and-loop attachment • Mopar Accessories are covered by either the 3-year/36,000-mile New Vehicle Limited Warranty, or the 12-month/12,000-mile Mopar Basic Limited Warranty, whichever is more favorable to the customer 	<ul style="list-style-type: none"> • Is it a universal fit? • Does it help prevent scratching? • Vehicle logo is exclusive to DaimlerChrysler Corporation • Is it a cheaper, vinyl material? • Does the warranty compare?

*Check your market for your competitive situation.

INSTALLATION:

Easily installed

Vehicle Line	MYO	MYI	Application Remarks	Part Number	Instl Time	Group	Sugg Retail Price
STORAGE BAGS							
Prowler	2001	1997	Storage/Utility Bag, nylon w/purple embroidered Prowler logo, (included in Vehicle Cover Kit PN 82202815)	82202816	D.I.Y.	T	60.00
Wrangler	2001	1997	Tailgate Storage Kit, Black, w/pockets and hook-and-loop cover attachment	82202391	D.I.Y.	T	76.00
	2001	1997	Window Storage Bag, 5 separate compartments, Black vinyl, w/Jeep logo	82203593	D.I.Y.	T	98.00
Viper Coupe	2001	1997	Storage/Utility Bag, gray nylon w/blue embroidered Viper GTS logo, (included in Vehicle Cover Kit PN 82202548)	82202821	D.I.Y.	T	60.00
	2001	1997	Storage/Utility Bag, gray nylon w/red embroidered Viper GTS logo, (included in Vehicle Cover Kit PN 82204192)	82204193	D.I.Y.	T	60.00
Viper RT/10	2001	1993	Storage/Utility Bag, gray nylon w/red embroidered Viper RT/10 logo, (included in Vehicle Cover Kit PN 82202275)	82202820	D.I.Y.	T	60.00
	2001	1992	Soft Top Carrier, black nylon, with Viper logo, attaches to Luggage Rack	82204415	D.I.Y.	T	66.00
	2001	1992	Storage Rack and Bag - Viper Hard Top	82204204	D.I.Y.	T	405.00

STORAGE PRODUCTS, UNDERSEAT STORAGE COMPARTMENT



Underseat Lockable Bin, open
(shown in Ram Pickup)



Underseat Lockable Bin, closed
(shown in Ram Pickup)

MOPAR FEATURES	COMPETITORS?*
<ul style="list-style-type: none"> • Turns rear underseat area into secure storage • Key lock prevents seat from being raised • Easy to install • Available in interior colors • Mopar Accessories are covered by either the 3-year/36,000-mile New Vehicle Limited Warranty or the 12-month/12,000-mile Mopar Basic Limited Warranty, whichever is more favorable to the customer 	<ul style="list-style-type: none"> • Does the warranty compare?

*Check your market for your competitive situation.

INSTALLATION:

Easy to install

Vehicle Line	MYO	MYI	Application Remarks	Part Number	Instl Time	Group	Sugg Retail Price
STORAGE PRODUCTS							
Ram Pickup - Club or Quad Cab	2001	1999	Underseat Storage Compartment - Lockable - Agate	82204472	0.5	T	190.00
	2001	1999	Underseat Storage Compartment - Lockable - Dark Mist Gray	82204470	0.5	T	190.00
	2001	1999	Underseat Storage Compartment - Lockable - Dark Tan	82204471	0.5	T	190.00

*NOTE: Cannot be installed on rear seats equipped with Underseat Storage Tray. If vehicle is equipped with rear Floor Mats, they must be removed.

SUNSHADES



Grand Cherokee and Cherokee



Wrangler



PT Cruiser



Dodge



Minivan

MOPAR FEATURES

- Fits the unique contours of vehicle's windshield
- Foldable
- Manufactured to DaimlerChrysler Corporation specifications for durability, flame resistance and other benefits
- Provides superior protection against UV rays and heat
- Exclusive vehicle logo
- Mopar Accessories are covered by either the 3-year/36,000-mile New Vehicle Limited Warranty, or the 12-month/12,000-mile Mopar Basic Limited Warranty, whichever is more favorable to the customer

COMPETITORS?*

- Is it a universal fit?
- Has it been tested for durability and long life?
- Logos are exclusive to DaimlerChrysler Corporation
- Does the warranty compare?

*Check your market for your competitive situation.

SUNSHADES (CONT.)

Vehicle Line	MYO	MYI		Application Remarks	Part Number	Instl Time	Group	Sugg Retail Price
SUNSHADES								
Avenger, Sebring Coupe	2000	1996	4000	Foldable, blocks UV sun rays and heat, w/Mopar logo	82203129	D.I.Y.	T	56.00
Breeze, Cirrus, Stratus, Sebring Sedan, Stratus Sedan	2001	1995	4000	Foldable, blocks UV sun rays and heat, 2-piece, w/Mopar logo	82203128	D.I.Y.	T	56.00
Cherokee	2001	1994	4300	Foldable, blocks UV sun rays and heat, w/Jeep logo	82203134	D.I.Y.	T	62.00
Concorde, Intrepid, LHS, 300M	2001	1994	4300	Foldable, blocks UV sun rays and heat, w/Mopar logo	82203131	D.I.Y.	T	56.00
Dakota (All)	2001	1988	4300	Foldable, blocks UV sun rays and heat, w/Rams Head Logo	82203137	D.I.Y.	T	62.00
Durango	2001	1998	4300	Foldable, blocks UV sun rays and heat, w/Rams Head Logo	82203137	D.I.Y.	T	62.00
Grand Cherokee	2001	1999	4300	Foldable, blocks UV rays and heat, w/Jeep logo	82203136	D.I.Y.	T	62.00
Minivan (All)	2001	1996		Foldable, blocks UV sun rays and heat, 2-piece w/ Mopar logo	82203138	D.I.Y.	T	69.00
Neon	2001	1995	4300	Foldable, blocks UV sun rays and heat, w/Neon logo	82205184	D.I.Y.	T	56.00
PT Cruiser	2001	2001	4300	Foldable, blocks UV sun rays and heat, with PT Cruiser logo	82205771	D.I.Y.	T	57.00
Ram Pickup (All)	2001	1994	4300	Foldable, blocks UV sun rays and heat, w/Rams Head Logo	82203132	D.I.Y.	T	62.00
Sebring Convertible, Sebring Convertible	2001	1996	4000	Foldable, blocks UV sun rays and heat, w/Sebring logo	82203130	D.I.Y.	T	56.00
Wrangler	2001	1997	4300	Foldable, blocks UV rays and heat, w/Jeep logo	82203133	D.I.Y.	T	62.00

TAILGATE PROTECTORS

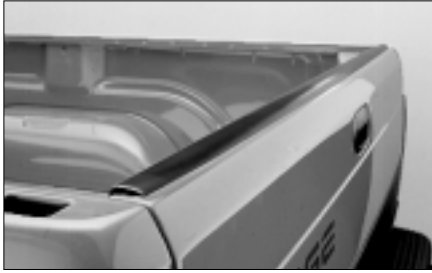

Plastic Tailgate Protector (shown on Ram Pickup)

MOPAR FEATURES	COMPETITORS?*
<ul style="list-style-type: none"> • Custom designed by DaimlerChrysler Corporation; molded plastic to fit top edge of tailgate • Protects tailgate top edge from damage when loading and unloading • Adds a smart styling accent to your truck • Mopar Accessories are covered by either the 3-year/36,000-mile New Vehicle Limited Warranty or the 12-month/12,000-mile Mopar Basic Limited Warranty, whichever is more favorable to the customer 	<ul style="list-style-type: none"> • Is it steel? Will it rust or corrode? • Does the warranty compare?

*Check your market for your competitive situation.

INSTALLATION:

- Same as original equipment
- Cannot be used with Bedliner Tailgate Cover

Vehicle Line	MYO MYI	Application Remarks	Part Number	Instl Time	Group	Sugg Retail Price
TAILGATE PROTECTORS						
Dakota (All)	2001 1997	Tailgate Cover, plastic	82203899*	0.2	J	36.00
Ram Pickup (All)	2001 1994	Tailgate Cover, plastic	82205217*	0.2	J	36.00

*Complete tailgate cover same as cover provided with Bedliner kits.

TIE-DOWNS



Easily installed

Hide-A-Hook® Bed Tie-Down (shown on Ram)

MOPAR FEATURES	COMPETITORS?*
<ul style="list-style-type: none"> • Help secure loose, lightweight cargo • Hook or loop retracts out of sight when not in use • Stainless steel construction, no rusting • Protective gasket between hook and metal • Mopar Accessories are covered by either the 3-year/36,000-mile New Vehicle Limited Warranty or the 12-month/12,000-mile Mopar Basic Limited Warranty, whichever is more favorable to the customer 	<ul style="list-style-type: none"> • Is it an above-rail style that gets in the way when loading? • Is it chrome-plated steel, which may rust? • Does it sit directly on metal, thereby promoting rust? • Does the warranty compare?

*Check your market for your competitive situation.

Hide-a-Hook and Hide-a-Loop are registered trademarks of Penda Corporation.

INSTALLATION:

- Install easily into existing stake pocket holes
- Gasket included to protect finish

Vehicle Line	MYO	MYI	Application Remarks	Part Number	Instl Time	Group	Sugg Retail Price
TIE DOWNS							
Ram Pickup (All)	2001	1994	Hide-a-Hook stainless steel, Bright (1 pair)	82203171	0.2	T	35.00
	2001	1994	Hide-a-Hook, Black	82205702	0.2	T	35.00
	2001	1994	Hide-a-Hook - Full Bed Set of Six	82401202	0.2		143.00
	2001	1994	Hide-a-Hook, Display Rack with 12 sets, Black	82206022	0.2		355.00
	2001	1994	Hide-a-Hook, Display Rack with 12 sets, Stainless	82206021	0.2		355.00
TIE DOWNS — QUANTITY PURCHASE							
Ram Pickup (All)	2000	1995	Multipack of 24 Pair of Hide-a-Hooks	82202229	0.2		

TIRE CARRIER, ROOF-MOUNT



Shown on Cherokee

MOPAR FEATURES	COMPETITORS?*
<ul style="list-style-type: none"> • Specifically designed for Cherokee • A convenient way to store the spare tire outside of the passenger compartment • Cherokee carrier mounts to the OE Roof Rack • E-coated steel construction, tubular style appearance • Mopar Accessories are covered by either the 3-year/36,000-mile New Vehicle Limited Warranty, or the 12-month/12,000-mile Mopar Basic Limited Warranty, whichever is more favorable to the customer 	<ul style="list-style-type: none"> • Does the warranty compare?

*Check your market for your competitive situation.

Vehicle Line	MYO	MYI	Application Remarks	Part Number	Instl Time	Group	Sugg Retail Price	
SPARE TIRE CARRIERS								
Cherokee	2001	1991	11000	Mounts to OE Roof Rack, accommodates all spare tire sizes	82203257	0.4	T	157.00

TONNEAU COVERS



Tonneau Cover (shown on Wrangler)



Tonneau Cover (shown on Wrangler with Wind Screen and Sun Bonnet)



Secures to Soft Top beltline hardware



Hook-and-loop attachment around Sports Bar

MOPAR FEATURES	COMPETITORS?*
<ul style="list-style-type: none"> • Uses beltline mounting hardware included with Soft Top • No snaps to snap, no channels to install • No drilling; uses preinstalled channel in beltline • Hook-and-loop attachment system affixes Tonneau around Sports Bar leg • Available in Black Denim, Stone White and Tan • Has been tested to withstand a variety of weather conditions • Thick thread and waxed seams make for improved resistance to water • Can be removed in minutes • Keeps cargo out of sight, protected from elements, allows rear seat to be either folded flat or forward • Flame-retardant fabric with backing to reduce road and wind noise • Mopar Accessories are covered by either the 3-year/36,000-mile New Vehicle Limited Warranty, or the 12-month/12,000-mile Mopar Basic Limited Warranty, whichever is more favorable to the customer 	<ul style="list-style-type: none"> • Does the soft top hardware have to be changed to install? • Is drilling required? • Does it align to the predrilled holes? • Does it fit snugly around the Sports Bar? • Does the fabric meet DaimlerChrysler Corporation standards for durability and color? • Is it water resistant? • Does it take a long time to remove? • Is the fabric flame retardant? • Does it have a backing? • Does the warranty compare?

*Check your market for your competitive situation.

INSTALLATION:

- Easily installs using Soft Top mounting system
- Hook-and-loop fasteners attach around the Sports Bar
- Use when Soft Top is down
- Fits from behind the front seat to the tailgate

Vehicle Line	MYO	MYI	Application Remarks	Part Number	Instl Time	Group	Sugg Retail Price
TONNEAU COVERS*							
Wrangler	2001	1997	Black, Vehicles with Hard Top removed requires Mounting Kit 82203316 to install tonneau	82202109	0.3	T	135.00
	2001	1999	Tan, Vehicles with Hard Top removed requires Mounting Kit 82203316 to install tonneau	82204601	0.3	T	135.00
TONNEAU COVERS, MOUNTING KIT — WRANGLER							
Wrangler	2001	1997	Kit allows Fabric Tonneau Covers to be installed on Wranglers originally manufactured with a Hard Top	82203316	0.5		60.00

*NOTE: Wrangler Tonneau Cover will only fit vehicles with Hardtop removed, requires Mounting Kit PN 82203316 to install Tonneau.

TONNEAU COVERS — FABRIC, SNAPLESS

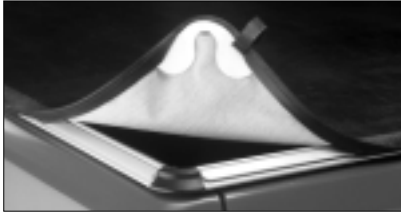

Easy access to truck bed

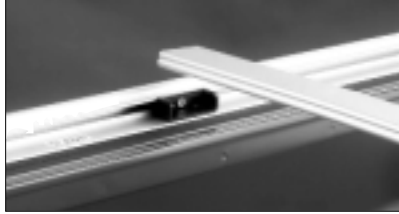

Bow attachment

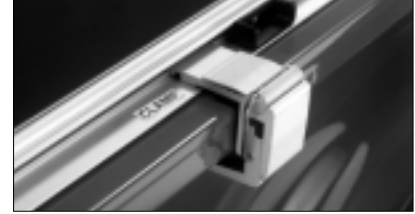

Frame attachment

MOPAR FEATURES

- Tough black vinyl fabric with polyester backing
- Shrink-resistant
- Mildew and waterproof fabric; UV-resistant
- “C” channel attachment system deters theft
- Keeps valuables out of sight
- Engineered to fit the unique bed dimensions
- Tailgate frame section can be easily removed for loading tall objects
- Complete one-piece lengths for 5.3', 6.5' or 8.0' beds; fabric attached to rail at bulkhead; provides easy access to truck bed
- Cast aluminum corner pieces
- More bows (6.5' bed = 3 bows, 8.0' bed = 4 bows); bows attach to clamps to help prevent snow and water buildup on fabric
- Anodized aluminum; aluminum frame system attaches to bed rail with exclusive clamp system, providing secure attachment
- Quick thumb screw disconnect for tailgate frame seam means easy removal when loading bigger objects
- Haartz® Tonneau Cover (Dakota Quad Cab™) includes same features of our other snapless tonneau covers with a premium, Haartz cloth cover
- Mopar Accessories are covered by either the 3-year/36,000-mile New Vehicle Limited Warranty or the 12-month/12,000-mile Mopar Basic Limited Warranty, whichever is more favorable to the customer

COMPETITORS?*

- Is it a universal fit? Does it fit Ram's unique bed dimensions?
- Does the frame consist of a 6.5' length plus a separate extension for 8' usage (two pieces)?
- Are the corner pieces made of plain steel, which may rust?
- Does it have as many bows?
- Is it made of plain steel, which may rust?
- Is the tailgate section permanently installed?
- Does the warranty compare?

*Check your market for your competitive situation.

INSTALLATION:

Not recommended for use with Over-The-Rail Bedliners

Vehicle Line	MYO	MYI	Application Remarks	Part Number	Instl Time	Group	Sugg Retail Price
TONNEAU COVERS — FABRIC, SNAPLESS*							
Dakota Quad Cab	2001	2000	Black, Snapless Style, 5.3 ft. bed	82205000	0.8	T	360.00
Dakota Regular & Club Cab	2001	1997	Black, Snapless Style, 6.5 ft. bed	82204995	0.8	T	300.00
Ram Pickup w/6.5 Ft. Bed	2001	1994	Black, Snapless Style, 6.5 ft. bed	82204996	0.8	T	300.00
Ram Pickup w/8.0 Ft. Bed	2001	1994	Black, Snapless Style, 8.0 ft. bed	82204998	0.8	T	320.00

*NOTE: Not for use with Over-the-Rail Bedliners.

TONNEAU COVERS — FABRIC, SNAP-STYLE



Tonneau Cover (shown on Dakota)



No drill attaching frame



Tonneau Cover snaps to frame



Clamps to side rail, includes bows

MOPAR FEATURES	COMPETITORS?*
<ul style="list-style-type: none"> • Engineered to fit the unique bed dimensions • Tailgate frame section can be easily removed for loading tall objects • Complete one-piece lengths for 6.5' or 8.0' beds • Mildew and waterproof fabric • UV-resistant; shrink-resistant fabric available in black • Cast aluminum corner pieces • More bows (6.5' bed = 3 bows, 8.0' bed = 4 bows); premium style includes a custom-fit, exclusive Mopar quick-release bow, rounded bow structure and custom end caps on tailgate frame • Anodized aluminum; aluminum frame system attaches to bed rail with exclusive clamp system, providing secure attachment • Quick thumb screw disconnect for tailgate frame means easy removal when loading bigger objects • Stainless steel snaps are used to attach fabric to rail system for quick attachment; fabric attached to rail at bulkhead • Mopar Accessories are covered by either the 3-year/36,000-mile New Vehicle Limited Warranty or the 12-month/12,000-mile Mopar Basic Limited Warranty, whichever is more favorable to the customer 	<ul style="list-style-type: none"> • Is it a universal fit? Does it fit Ram's unique bed dimensions? • Does the frame consist of a 6.5' length plus a separate extension for 8' usage (two pieces)? • Are the corner pieces made of plain steel, which may rust? • Does it have as many bows? • Is it made of plain steel, which may rust? • Is the tailgate section permanently installed? • Does the warranty compare?

*Check your market for your competitive situation.

INSTALLATION:

- No drilling, easy to install
- Removable
- Not recommended with Over-Rail Bedliners

TONNEAU COVERS — FABRIC, SNAP-STYLE (CONT.)

Vehicle Line	MYO	MYI	Application Remarks	Part Number	Instl Time	Group	Sugg Retail Price
TONNEAU COVERS — FABRIC, SNAP-STYLE*							
Dakota Regular & Club Cab	2001	1997	Black, Snap-Style, 6.5 ft. bed	82202723	0.6	T	310.00
	2001	1997	Black, Premium Snap-Style, 6.5 ft. bed	82203122	0.6	T	360.00
Ram Pickup w/6.5' Bed	2001	1994	Black, Snap-Style, 6.5 ft. bed	82203124	0.6	T	310.00
	2001	1994	Black, Premium Snap-Style, 6.5 ft. bed	82401379	0.6	T	360.00
Ram Pickup w/8.0 Ft. Bed	2001	1994	Black, Snap-Style, 8.0 ft. bed	82203125	0.6	T	310.00
	2001	1994	Black, Premium Snap-Style, 8.0 ft. bed	82401380	0.6	T	360.00

*NOTE: Not for use with Over-the-Rail Bedliners.

TONNEAU COVERS — GULL WING STYLE, FIBERGLASS



Gull Wing Style Tonneau Cover
(shown open on Dakota Quad Cab™)



Gull Wing Style Tonneau Cover
(shown closed on Dakota Quad Cab)



Cargo Area Tray

MOPAR FEATURES

- Brand new innovative design provides superior versatility and functionality by allowing easy access to items stored at front of bed
- Premium cover is reinforced for durability and has corrosion-resistant aluminum frame for added strength
- Protective color-matched trim molding provides smooth-finished edge while rubber bumpers help reduce noise
- Sturdy lock controls both tonneau cover and tailgate access
- Mopar Accessories are covered by either the 3-year/36,000-mile New Vehicle Limited Warranty or the 12-month/12,000-mile Mopar Basic Limited Warranty, whichever is more favorable to the customer

COMPETITORS?*

- Will it rust?
- Is it lockable? Can you lock both cover and tailgate?
- Is the edge bare fiberglass?
- Is the color selection limited? Will it match perfectly?
- Does the warranty compare?

*Check your market for your competitive situation.

Vehicle Line	MY0	MY1	Application Remarks	Part Number	Instl Time	Group	Sugg Retail Price
TONNEAU COVERS — GULL WING STYLE, FIBERGLASS*							
Dakota Quad Cab	2001	2000	Cargo Organizer Tray — fits in bedliner grooves, use w/Under-the-Rail Bedliner and Gull Wing Tonneau Cover	82206435	D.I.Y.		115.00
	2001	2000	Bright Silver Metallic (WSB)	82206991	0.8		960.00
	2001	2000	Amber Fire (PV3)	82205079	0.8		960.00
	2001	2000	Black (PX8)	82205069	0.8		960.00
	2001	2000	Bright White (PW7)	82205070	0.8		960.00
	2001	2000	Dark Garnet Red (PRV)	82205077	0.8		960.00
	2001	2000	Flame Red (PR4)	82205072	0.8		960.00
	2001	2000	Forest Green (PG8)	82205073	0.8		960.00
	2001	2000	Intense Blue (PB3)	82205074	0.8		960.00
	2000	2000	Light Driftwood (PFA)	82205071	0.8		960.00
	2001	2000	Patriot Blue (PBT)	82205076	0.8		960.00
	2001	2000	Sierra Bronze (PTL)	82205078	0.8		960.00
	2000	2000	Solar Yellow (PYH)	82205075	0.8		960.00

*NOTE: Not for use with Over-the-Rail Bedliners.

TONNEAU COVERS — HARD, FOLDING



Tonneau Cover (shown on Ram Pickup)



Frame attaches with adhesive (shown on Ram Pickup)



Folding design (shown on Ram Pickup)

MOPAR FEATURES	COMPETITORS?*
<ul style="list-style-type: none"> • Anodized aluminum frame and panel covers; lightweight • All stainless steel hardware • Each panel is constructed of an aluminum cover bonded to EPS extruded polystyrene filler for strength and rigidity • Durable aluminum and stainless steel construction — resists cracking, sagging and fading • Factory-approved adhesive secures frame to bed rail • Folding construction provides quick access to all or part of bed • Folds up in stack behind cab without blocking visibility • Can be folded halfway or can cover completely • Protects and provides easy access to pickup bed • Allows hauling of tall loads or towing of fifth-wheel trailers without removing cover • Locking feature provides added security for valuables • Black color complements vehicle trim • Mopar Accessories are covered by either the 3-year/36,000-mile New Vehicle Limited Warranty or the 12-month/12,000-mile Mopar Basic Limited Warranty, whichever is more favorable to the customer 	<ul style="list-style-type: none"> • Is it anodized aluminum? • Is the hardware made of plain steel, which may rust? • Are the panels made of fiberglass, which may chip or crack? • Does installation require drilling many holes in the bed rail? • Is it a one-piece style that may prevent the use of a fifth-wheel trailer? • Does the warranty compare?

*Check your market for your competitive situation.

INSTALLATION:

- Frame attaches with adhesive strip and clamps
- Some drilling required
- Not recommended for use with Over-Rail Bedliners

TONNEAU COVERS — HARD, FOLDING (CONT.)

Vehicle Line	MYO	MYI	Application Remarks	Part Number	Instl Time	Group	Sugg Retail Price
TONNEAU COVERS — HARD, FOLDING*							
Dakota Quad Cab	2001	2000	Black, folding, for 5.3 ft. bed (Quad Cab), includes hardware and locks	82205224	0.4	T	740.00
Dakota Regular & Club Cab	2001	1993	Installation Hardware and Lock Package, 6.5 ft. bed, use with folding covers PN 82202727 and PN 82203920	82203246	0.8	T	275.00
	2001	1997	Black, folding Cover, 6.5 ft. bed (Standard or Club Cab), requires Installation Hardware and Lock Package	82202727	0.4	T	470.00
Ram Pickup w/6.5 Ft. Bed	2001	1994	Installation Hardware and Lock Package, 6.5 ft. bed, use with folding covers PN 82202727 and PN 82203920	82203246	0.8	T	275.00
	2001	1994	Black, folding, for 6.5 ft. bed, requires Installation Hardware and Lock Package	82203920	0.4	T	515.00
Ram Pickup w/8.0 Ft. Bed	2001	1994	Installation Hardware and Lock Package, 8.0 ft. bed, use with folding cover PN 82203921	82203247	0.8	T	275.00
	2001	1994	Black, folding, for 8.0 ft. bed, requires Installation Hardware and Lock Package	82203921	0.4	T	515.00

*NOTE: Not for use with Over-the-Rail Bedliners.

TONNEAU COVERS — ONE-PIECE FIBERGLASS



Fiberglass Tonneau Cover
(shown on Ram Pickup)



Fiberglass Tonneau Cover
(shown on Dakota)



Rubber bumpers
eliminate noise



Lip molding provides
finished look

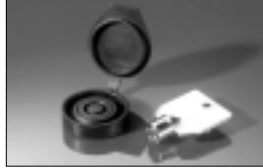

Sealed lock

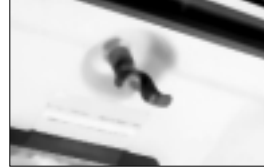

Locking latches

MOPAR FEATURES

- Convenient one-hand opening with gas strut and latch system
- Latching and sealable locking system secures Tonneau Cover and tailgate for added peace of mind
- Fiberglass dual wall construction with 100% pure resin reinforced honeycomb for structural strength; rust-free aluminum frame provides maximum strength and protection
- Trim molding provides finished look and splinter-free edge; rubber bumpers help reduce noise
- Comes in colors to match select body colors; unique design for a perfect fit; SS/T Stripe Kits available for 6.5' tonneaus
- Mopar Accessories are covered by either the 3-year/36,000-mile New Vehicle Limited Warranty or the 12-month/12,000-mile Mopar Basic Limited Warranty, whichever is more favorable to the customer

COMPETITORS?*

- Are struts gas-assisted or are they manual?
- Is it lockable? Can you lock both cover and tailgate?
- Is it a heavier, weaker single-wall construction?
- Is the edge bare fiberglass?
- Is the color selection limited? Will it match perfectly?
- Is it manufactured of 100% pure resin?
- Has it passed DaimlerChrysler durability tests?
- Is it easily removable?
- Does the warranty compare?

*Check your market for your competitive situation.

Please call (800) OE LINER to place an order.

INSTALLATION:

- Frame attaches with clamps
- Some drilling required for latch

TONNEAU COVERS — ONE-PIECE FIBERGLASS (CONT.)

Vehicle Line	MYO	MYI	Application Remarks	Part Number	Instl Time	Group	Sugg Retail Price
TONNEAU COVERS — ONE-PIECE FIBERGLASS*†							
Dakota Regular & Club Cab	2001	2000	Bright Silver Metallic (WSB)	82206992	1.2		830.00
	2000	1998	Deep Amethyst (PCU)	82204161	1.2		805.00
	2000	1997	Metallic Red (PRF)	82204376	1.2		805.00
	2000	1997	Solar Yellow (PYH)	82205105	1.2		805.00
	2001	2000	Amber Fire (PV3)	82205800	1.2		830.00
	2001	1997	Bright White (PW7)	82204370	1.2		830.00
	2001	2000	Dark Garnet Red (PRV)	82205798	1.2		830.00
	2001	1997	Flame Red (PR4)	82204368	1.2		830.00
	2001	1998	Forest Green (PG8)	82204160	1.2		830.00
	2001	1997	Gloss Black (PX8)	82204366	1.2		830.00
	2001	1998	Intense Blue (PB3)	82204162	1.2		830.00
	2000	1997	Light Driftwood (PFA)	82204374	1.2		830.00
	2001	2000	Patriot Blue (PBT)	82205797	1.2		830.00
	2001	2000	Sierra Bronze (PTL)	82205799	1.2		830.00
Ram Club Cab, Ram Regular Cab w/6.5' Bed	2001	2001	Amber Fire (XVL)	82206602	1.2		845.00
	2001	2001	Bright Silver Metallic (WSB)	82206603	1.2		845.00
	2001	2000	Patriot Blue (PBT)	82205940	1.2		845.00
	2000	1997	Chestnut (TU1)	82204386	1.2		820.00
	2000	1998	Deep Amethyst (PCU)	82204165	1.2		820.00
	2000	1996	Light Driftwood (PFA)	82204390	1.2		820.00
	2000	1997	Metallic Red (PRF)	82204388	1.2		820.00
	2001	1994	Black (PX8)	82204380	1.2		845.00
	2001	1994	Bright White (PW7)	82204378	1.2		845.00
	2001	2000	Dark Garnet Red (PRV)	82205802	1.2		845.00
	2001	1994	Flame Red (PR4)	82204382	1.2		845.00
	2001	1998	Forest Green (PG8)	82204163	1.2		845.00
	2001	1998	Intense Blue (PB3)	82204167	1.2		845.00
	2001	2000	Patriot Blue (PBT)	82205801	1.2		845.00
2001	2000	Sierra Bronze (PTL)	82205803	1.2		845.00	
2000	1998	Solar Yellow (PYH)	82205104	1.2		820.00	

*NOTE: Not for use with Over-Rail Bedliners.

† To order, please call 1-800-OE LINER.

TONNEAU COVERS — POP-UP, SOFT



Pop-Up Soft Style Tonneau Cover

MOPAR FEATURES	COMPETITORS?*
<ul style="list-style-type: none"> • Opens like trunk lid • Premium Haartz® fabric • “Quick Latch” frame allows for easy opening/closing of the cover • Mopar Accessories are covered by either the 3-year/36,000-mile New Vehicle Limited Warranty or the 12-month/12,000-mile Mopar Basic Limited Warranty, whichever is more favorable to the customer 	<ul style="list-style-type: none"> • Does it open like a trunk lid? • Do they have Premium Haartz fabric? • Does the warranty compare?

*Check your market for your competitive situation.

Vehicle Line	MY0	MY1	Application Remarks	Part Number	Instl Time	Group	Sugg Retail Price
TONNEAU COVERS — PREMIUM HAARTZ FABRIC, POP-UP STYLE*							
Dakota Quad Cab	2001	2000	Black, Premium Haartz fabric, Pop-up style, w/hinged frame, 5.3-ft bed	82206317	1.0	T	570.00
Dakota Regular & Club Cab	2001	1997	Black, Premium Haartz fabric, Pop-up style, w/hinged frame, 6.5-ft bed	82206130	1.0	T	570.00
Ram Pickup w/6.5 Ft. Bed	2001	1994	Black, Premium Haartz fabric, Pop-up style, w/hinged frame, 6.5-ft bed	82206131	1.0	T	570.00
Ram Pickup w/8.0 Ft. Bed	2001	1994	Black, Premium Haartz fabric, Pop-up style, w/hinged frame, 8.0-ft bed	82206132	1.0	T	570.00

*NOTE: Not for use with Over-the-Rail Bedliners.

TOOL BOXES

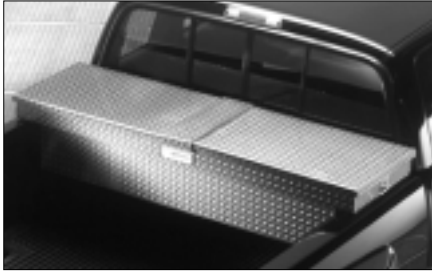

Diamond Plate Tool Box
(shown closed on Ram Pickup)

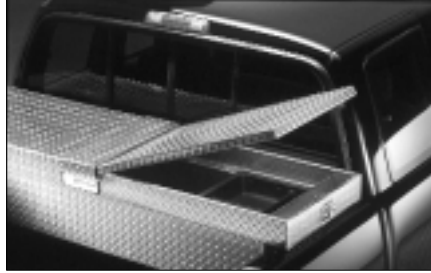

Diamond Plate Tool Box
(shown open on Ram Pickup)

MOPAR FEATURES	COMPETITORS?*
<ul style="list-style-type: none"> • Three-piece body-weld construction; .072" thickness vs .063" for some aftermarket boxes; 14.25" high • Made from bright tread anodized aluminum with a protective seal coat • Water-resistant body with foam tape • Adjustable striker, both vertical and horizontal • Gas spring supports for Tool Box lid allows it to open with ease; full-width stainless steel hinges are riveted to box • Includes Mopar exclusive bed support brackets and gaskets for added sheet metal strength • Stainless steel latches; stainless steel locking handle with two sets of keys • Mopar logo • Mopar Accessories are covered by either the 3-year/36,000-mile New Vehicle Limited Warranty or the 12-month/12,000-mile Mopar Basic Limited Warranty, whichever is more favorable to the customer 	<ul style="list-style-type: none"> • Is it a three-piece weld construction? • Is it bright tread anodized aluminum? • Is it water-resistant? • Is the striker adjustable? • Is the lid counterbalanced or does it slam shut? • Are support brackets/gaskets included? Will box deform vehicle's sheet metal or bed? • Are they made of steel that may rust or plastic that may break? • Does the warranty compare?

*Check your market for your competitive situation.

INSTALLATION:

- Includes bracket and gasket material to secure box to bed
- Mopar exclusive bed support brackets included

Vehicle Line	MYO	MYI	Application Remarks	Part Number	Instl Time	Group	Sugg Retail Price
TOOL BOXES							
Dakota Regular & Club Cab	2001	1997	Silver, diamond plate design, includes locks, 2 bed reinforcement bars, fasteners, gaskets and Mopar logo, w/dual lid opening	82202791	0.7	T	535.00
	2001	1997	Silver, diamond plate design, includes locks, 2 bed reinforcement bars, fasteners, gaskets and Mopar logo, w/single lid opening	82203111	0.7	T	535.00
Ram Pickup (All)	2001	1994	Silver, diamond plate design, includes locks, 2 bed reinforcement bars, fasteners, gaskets and Mopar logo, w/dual lid opening	82203113	0.7	T	535.00
	2001	1994	Silver, diamond plate design, includes locks, 2 bed reinforcement bars, fasteners, gaskets and Mopar logo, w/single lid opening	82203112	0.7	T	535.00

TOPS, HARDTOP



Hardtop (shown on Wrangler)



Hardtop



Door Assembly



Body Wiring Harness



Door Trim Kit

MOPAR FEATURES	COMPETITORS?*
<ul style="list-style-type: none"> • “Quick-release” header latches • Design is identical to original equipment • Provides all-weather protection and superior sealing • Windows and liftgate are tinted • Includes rear wiper and washer • High-flow exhausters on rear corners enhance front-to-rear ventilation • Mopar Accessories are covered by either the 3-year/36,000-mile New Vehicle Limited Warranty, or the 12-month/12,000-mile Mopar Basic Limited Warranty, whichever is more favorable to the customer 	<ul style="list-style-type: none"> • Are latches complicated? • Does design meet DaimlerChrysler OE standards? • Are windows and liftgate tinted? • Will it cost extra to have them tinted? • Are rear wiper and washer included? • Does hardtop have rear corner exhausters? • Will ventilation be enhanced? • Does the warranty compare?

*Check your market for your competitive situation.

INSTALLATION:

- Same as original equipment
- Order appropriate Installation Package for a complete OE installation

Vehicle Line	MY0	MY1	Application Remarks	Part Number	Instl Time	Group	Sugg Retail Price
CONVERSION COMPONENTS — INSTALL A SOFT TOP ON A HARD TOP VEHICLE							
Wrangler	2001	1999	Upper Door Kit, Tan Polycotton, includes both fabric upper door halves, w/frames and soft windows	82204554	D.I.Y		320.00
	2001	2001	Black Denim, Premium Sail Cloth, Window Kit, Door-Frt	82206625	D.I.Y.		355.00
	2001	2001	Tan, Premium Sail Cloth, Window Kit, Door-Frt	82206626	D.I.Y		355.00
	2001	1997	Upper Door Kit, Black Denim Polycotton, includes both fabric upper door halves, w/frames and soft windows	82202129	D.I.Y.		355.00

TOPS, HARDTOP (CONT.)

Vehicle Line	MYO	MYI	Application Remarks	Part Number	Instl Time	Group	Sugg Retail Price
CONVERSION COMPONENTS — INSTALL HARD TOP ON A SOFT TOP VEHICLE							
Wrangler	2001	1997	Hinge and Mirror Package, includes all four door hinges (primed), and both mirrors (black), saves having to remove hinges and mirrors from Soft Top half doors	82203488	0.6	T	115.00
	2001	1999	Door Trim Package, Agate, includes interior trim panels, lock cylinders, window cranks, seals and gaskets to complete one set of doors	82205113	0.6	T	149.00
	2001	1999	Door Trim Package, Camel, includes interior trim panels, lock cylinders, window cranks, seals and gaskets to complete one set of doors	82205114	0.6	T	149.00
HARD TOP							
Wrangler	2000	1997	Switch and Wiring Package, includes wiring harness and switches to operate dome light, defroster, wiper and washer	82205621	1.0	T	91.00
	2001	2001	Switch and Wiring Package, includes wiring harness and switches to operate dome light, defroster, wiper and washer	TBD	1.0	T	TBD
	2001	1997	Black Hardtop, medium tint windows side, light tint rear	82203607	0.8	T	1700.00
	2000	1997	Stone White Hardtop, medium tint windows side, light tint rear	82203608	0.8	T	1700.00
	2001	1999	Tan Hard Top, medium tint windows side, light tint rear	82204706	0.8	T	1700.00

TOPS, SOFT TOP



Soft Top used with half doors
(doors sold separately)



Wider side window surface



New retractable design



Tailgate attachment



Wider Rear Window



All-new frame insert for
doors makes for tighter fit



Soft Top used with
full-length doors



New windshield latch system



New retraction system; easy
as a convertible



Heavier zipper, hook-and-loop
fasteners for tighter seal;
easier to use

MOPAR FEATURES

- Jeep® exclusive plastic header with two quick-release latches
- Zipper and hook-and-loop fastener around windows for a better seal
- Larger side and rear windows than previous Wrangler
- Lower frame profile when the top is down
- Predrilled Sports Bar accommodates top, no drilling
- Removable windows resist cracking and clouding
- 10 pounds lighter than previous top for easier use
- The same top can be used with full or half doors
- Premium heavy-duty sail cloth fabric for reduced interior road noise; available in Black Denim and Tan
- No snaps to snap, no channels to install
- Fold-and-tumble™ for rear seat operation for convertible-like use
- Jeep engineering-tested to meet a variety of weather conditions
- Mopar Accessories are covered by either the 3-year/36,000-mile New Vehicle Limited Warranty, or the 12-month/12,000-mile Mopar Basic Limited Warranty, whichever is more favorable to the customer

COMPETITORS?*

- Is it attached from outside the vehicle with unsightly fasteners?
- Is it a lighter seal; is there more wind noise?
- Are the windows the same size as the previous Wrangler?
- Is it the same old frame design that stacks high?
- Is drilling required?
- Can the windows be removed; do they cloud up?
- Is it a heavy top?
- Is the top compatible to both vehicle door systems?
- Is it coated?
- Does it reduce interior road noise?
- Does the top snap on?
- Do you have to drill and install side window channels?
- Is it difficult to raise and lower?
- Does it leak wind, water, snow, sand, etc.?
- Does the warranty compare?

*Check your market for your competitive situation.

TOPS, SOFT TOP (CONT.)

Vehicle Line	MYO	MYI	Application Remarks	Part Number	Instl Time	Group	Sugg Retail Price
SOFT TOPS							
Wrangler	2001	1997	Black Vinyl Cotton, Hard Top Replacement	82202125	2.5	T	995.00
	2001	1999	Tan Vinyl Cotton, Hard Top Replacement	82204553	2.5	T	995.00
	2001	2001	Black Denim, Premium Sail Cloth, Hard Top Replacement	82206623	2.5	T	1100.00
	2001	2001	Tan, Premium Sail Cloth, Hard Top Replacement	82206624	2.5	T	1100.00
SOFT TOPS — QUANTITY PURCHASE							
Wrangler	2001	1997	Black Vinyl Cotton, Quantity purchase of seven Black Soft Tops	82202377	2.5		
	2001	1999	Tan Vinyl Cotton, Quantity purchase of seven Tan Soft Tops	82204633	2.5		
	2001	1997	Black Denim, quantity purchase of seven Black Soft Tops	82206884	2.5		
	2001	1999	Tan Sail Cloth, quantity purchase of seven Tan Soft Tops	82206885	2.5		

TOPS, SOFT TOP BOOT



Soft Top Boot



Pocket with zipper for window storage



Secure to belt rail

MOPAR FEATURES	COMPETITORS?*
<ul style="list-style-type: none"> • High-quality YKK zippers are made of long-lasting acetyl resin, have a greater number of teeth and meet alignment and tolerance requirements • Can be removed in minutes • Hook-and-loop fasteners around the side quarter and rear for added sealing • Flame-retardant fabric with backing • Boot is made of a tough, vinyl-coated cotton/polyester blend and uses heavy-duty reinforced stitching • Available in Black Denim and Dark Tan • Mopar Accessories are covered by either the 3-year/36,000-mile New Vehicle Limited Warranty, or the 12-month/12,000-mile Mopar Basic Limited Warranty, whichever is more favorable to the customer 	<ul style="list-style-type: none"> • Are the zippers made of nylon? • Do they have fewer teeth, enabling easier misalignment after repeated use? • Does it take a long time to remove? • Is the fabric flame retardant? • Does it have a backing? • Does the color match? • Does the warranty compare?

*Check your market for your competitive situation.

INSTALLATION:

- Easily installs over folded Soft Top
- Seals with hook-and-loop fasteners

Vehicle Line	MYO	MYI	Application Remarks	Part Number	Instl Time	Group	Sugg Retail Price
SOFT TOP BOOT							
Wrangler	2000	1997	Soft Top Boot - Black Denim	82202118	0.2	T	129.00
	2000	1999	Soft Top Boot - Tan	82204555	0.2	T	135.00
	2001	1997	Soft Top Boot - Black Denim	82206874	0.2	T	230.00
	2001	1997	Soft Top Boot - Tan	82206873	0.2	T	230.00

TOPS, SUN BONNET (HALF-TOP)

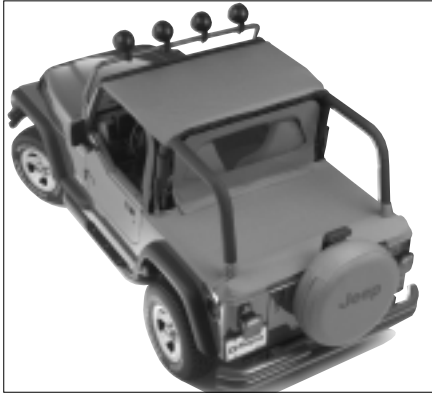

Sun Bonnet Top (Bikini Style), includes hardware



Secures with straps to Sports Bar

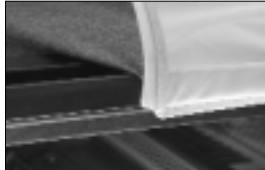

Custom attachment design exclusive to Mopar for use with the Soft Top door frame

MOPAR FEATURES

- Door attachment is a Mopar exclusive; it eliminates dangling straps, providing a neat appearance
- Thick thread and waxed seams make for an improved resistance to water
- Custom design attachment
- Use with or without Sound Bar
- Channel-style installation — no snaps
- Mopar Accessories are covered by either the 3-year/36,000-mile New Vehicle Limited Warranty, or the 12-month/12,000-mile Mopar Basic Limited Warranty, whichever is more favorable to the customer

COMPETITORS?*

- Do the rear straps tie to the rear tailgate area or rear seats?
- Do the tie-down straps restrict rear-seat usage?
- Does the fabric meet DaimlerChrysler Corporation standards for durability?
- Is it water resistant?
- Does it interfere with Hardtop/Soft Top use?
- Is it one size fits all — that doesn't?
- Does it use difficult-to-fasten snaps?
- Does the warranty compare?

*Check your market for your competitive situation.

INSTALLATION:

- Attaches to specially designed windshield hardware
- Secured with straps to the Sports Bar
- Use soft top plastic door frame

Vehicle Line	MY0	MY1	Application Remarks	Part Number	Instl Time	Group	Sugg Retail Price
SUN BONNETS (HALF-TOPS)*							
Wrangler	2001	1997	Mounting Hardware Package	82202094	0.2	T	34.75
	2000	1999	Tan, Soft Top kit, used w/ or w/o Sound Bar	82204556	0.4	T	101.00
	2001	1997	Black, Hardtop kit, used w/ or w/o Sound Bar	82204282	0.5	T	106.00
	2001	1997	Black, Soft Top kit, used w/ or w/o Sound Bar	82204874	0.4	T	106.00
	2001	1999	Tan, Hardtop kit, used w/ or w/o Sound Bar	82204557	0.5	T	106.00
	2001	1997	Tan, Soft Top kit, used w/ or w/o Sound Bar	82204873	0.4	T	106.00

*Works with Soft Top vehicles only.

TOPS, SUN BONNET, TONNEAU & WINDSCREEN COMBINATION



Combo Kit includes Sun Bonnet, Tonneau Cover and Windscreen



Sun Bonnet



Tonneau Cover



Windscreen and Tonneau

MOPAR FEATURES	COMPETITORS?*
<ul style="list-style-type: none"> • Kit includes Sun Bonnet, Tonneau Cover and Windscreen in one package, all in the same color • Available in Black Denim and Dark Tan • Save by buying the Combo Kit rather than each separately • Mopar Accessories are covered by either the 3-year/36,000-mile New Vehicle Limited Warranty, or the 12-month/12,000-mile Mopar Basic Limited Warranty, whichever is more favorable to the customer 	<ul style="list-style-type: none"> • Do they offer a cost-saving combo? • Does the warranty compare?

*Check your market for your competitive situation.

FOR ADDITIONAL PRODUCT FEATURES:

- Refer to page 254 for Sun Bonnet (Half Top)
- Refer to page 238 for Tonneau Covers
- Refer to page 256 for Windscreen

Vehicle Line	MYO	MYI	Application Remarks	Part Number	Instl Time	Group	Sugg Retail Price
SUN BONNET, TONNEAU & WINDSCREEN COMBINATIONS							
Wrangler	2001	1997	Black, used w/ or w/o sound bar	82202998*	1.0	T	255.00
	2001	1999	Tan, used w/ or w/o sound bar	82204559*	1.0	T	255.00

*NOTE: Wrangler Tonneau Cover will only fit vehicles with Hardtop removed, requires Mounting Kit PN 82203316 to install Tonneau.

TOPS, WINDSCREEN



Windscreen, use behind front seat

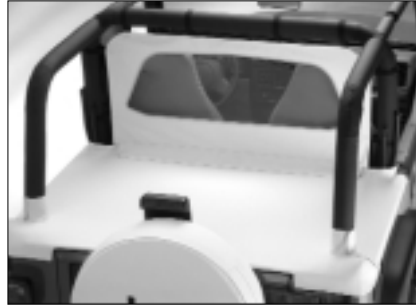

Attaches to Sports Bar



Hook-and-loop attachment

MOPAR FEATURES

- Windscreen is made of a tough, vinyl-coated cotton/polyester blend and uses heavy-duty reinforced stitching
- Available in Black Denim and Dark Tan
- Thick thread and waxed seams make for an improved resistance to water
- Reduces wind buffeting when top is removed for quieter, more pleasant driving
- Keeps heat in front seat area in winter
- Has been tested to withstand a variety of weather conditions
- Can be removed in minutes
- High-quality window plastic resists clouding
- Pass-through access to rear-seat area
- Fits behind the front seat
- Mopar Accessories are covered by either the 3-year/36,000-mile New Vehicle Limited Warranty, or the 12-month/12,000-mile Mopar Basic Limited Warranty, whichever is more favorable to the customer

COMPETITORS?*

- Does it match fabric and color of OE Soft Top?
- Is it water resistant?
- Does it take a long time to remove?
- Will window cloud over time?
- Can you reach items in rear-seat area?
- Does the warranty compare?

*Check your market for your competitive situation.

INSTALLATION:

Attaches to Sports Bar with hook-and-loop fasteners, to floor with mounting plate bracket and to Tonneau Cover with snaps



Secured with floor mounting bracket



Snaps to available Tonneau Cover

Vehicle Line	MYO	MYI	Application Remarks	Part Number	Instl Time	Group	Sugg Retail Price
TOPS, WINDSCREEN							
Wrangler	2001	1999	Tan	82204558	1.0	T	103.00
	2001	1997	Black	82202379	1.0	T	103.00

TOW HOOKS, JEEP®



Front Tow Hook (shown on Grand Cherokee)



Front-Mount Tow Hook (shown on Cherokee)



Tow Hooks mounted on OE bumper (shown on Wrangler)

MOPAR FEATURES	COMPETITORS?*
<ul style="list-style-type: none"> • Custom-designed mounting brackets attach to frame • Forged steel construction • Hooks rated at 5,000 lbs per side • Heavy-duty Tow Hooks are perfect for winching out of tight spots • Tested by DaimlerChrysler Corporation to ensure rated performance • Designed to meet Federal Motor Vehicle Safety Standards for occupant protection • Mopar Accessories are covered by either the 3-year/36,000-mile New Vehicle Limited Warranty, or the 12-month/12,000-mile Mopar Basic Limited Warranty, whichever is more favorable to the customer 	<ul style="list-style-type: none"> • Are they mounted to the bumper? • What is the hook capacity? • Has it been tested? • Is it designed to meet government regulations? • Does the warranty compare?

*Check your market for your competitive situation.

INSTALLATION:

- Front kit includes two hooks, left and right mounting brackets and attaching hardware
- Rear kit includes single hook, mounting brackets and attaching hardware
- 4WD only
- Install on original equipment bumper only (Wrangler)

Vehicle Line	MYO	MYI	Application Remarks	Part Number	Instl Time	Group	Sugg Retail Price
TOW HOOKS							
Cherokee	2001	1997	Black, front, set of two, 5,500-lb. capacity	82202864	1.5	T	129.00
Cherokee, Wrangler	2001	1984	Black, rear, single hook, mounts to Hitch Receiver, 4,000-lb capacity	82202583	0.5	T	30.00
Grand Cherokee	2001	1999	Black, rear, single hook, for use w/o Hitch Receiver only, 4,000-lb capacity	82204487	0.5	T	59.00
		1999	Black, front, set of two, 5,000-lb capacity	82204486	1.0	T	96.00
Wrangler	2001	1997	Black, front, set of 2, 5,000-lb capacity	82202186	0.5	T	48.00
		1997	Black, rear, set of 2, 4,000-lb capacity, for use w/o Hitch Receiver only	82204120	0.5	T	119.00
		1997	Set of two Chrome-plated Rear Tow Hooks, rated at 4,000 pounds each	82204121	0.5	T	130.00

TOW HOOKS, TRUCK



Wide Tow Hooks



Mounts to frame



Kit contents

MOPAR FEATURES

- 5.0-inch wide, massive hook design for easier handling
- Heavy-duty Tow Hooks are perfect for winching out of tight spots
- Custom-designed mounting brackets attach to frame
- Forged steel construction
- 5,500-lb pulling capacity (each side)
- Durable black powder-coat finish
- Proving Grounds-tested to ensure tow rating capacity
- Mopar Accessories are covered by either the 3-year/36,000-mile New Vehicle Limited Warranty or the 12-month/12,000-mile Mopar Basic Limited Warranty, whichever is more favorable to the customer

COMPETITORS?*

- Is it 5.0-inch wide or less?
- Are they mounted to the bumper?
- Have they been tested to ensure tow rating capacity?
- Does the warranty compare?

*Check your market for your competitive situation.

INSTALLATION:

- Kit includes two hooks, left and right mounting brackets and attaching hardware
- All 4WD and 2500/3500 heavy-duty 2WD models only

Vehicle Line	MYO	MYI	Application Remarks	Part Number	Instl Time	Group	Sugg Retail Price
TOW HOOKS							
Durango, Ram Pickup	2001	1994	Black, rear, single hook, mounts to Hitch Receiver, 4,000-lb capacity	82202583	0.5	T	30.00
Ram Pickup - All ex 1500 4x2	2001	1994	Set of two black Front Tow Hooks, rated at a capacity of 5,500-lbs each, For 2001/99 Ram Sport Pickups, Front Bumper fascia must be modified	82204881	1.3	T	139.00
Ram Van/Wagon, Dakota (All)	2001	1994	Black, rear, single hook, mounts to Hitch Receiver, 4,000-lb capacity	82202583	0.5	T	30.00

TRAILERS, PROWLER

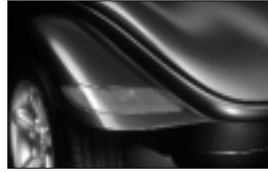

MOPAR FEATURES	COMPETITORS?*
<ul style="list-style-type: none"> • Provides added storage space • Follows Prowler construction cues with fiberglass body, aluminum frame and independent suspension • Premium tires, exclusive aluminum Prowler-look wheels and Prowler OE taillights provide the distinct Prowler look • Equipped with chrome-plated aluminum wheels • Automotive quality weather stripping, wiring, lights, carpet and locking hardware • Dual gas struts for deck lid • 1,000-lb rating • Mopar Accessories are covered by either the 3-year/36,000-mile New Vehicle Limited Warranty, or the 12-month/12,000-mile Mopar Basic Limited Warranty, whichever is more favorable to the customer 	<ul style="list-style-type: none"> • No known comparable product on the market • Does the warranty compare?

*Check your market for your competitive situation.

INSTALLATION:

Easy installation

Vehicle Line	MY0	MY1	Application Remarks	Part Number	Instl Time	Group	Sugg Retail Price
TRAILERS — PROWLER*							
Prowler	2001	1997	Prowler Trailer Kit - unassembled and primed	82204199	D.I.Y.		3400.00
	2001	2001	Black Tie Edition, equipped with chrome plated cast aluminum wheels and tires, made of composite material/aluminum, painted two tone black top over a Silver body. Includes wiring, lights and carpet. Uses a 1 7/8" Hitch Ball (freight included)	82206372	0.5		5075.00
	2001	1997	Black; equipped w/chrome-plated cast aluminum wheels and tires; made of composite material/aluminum; includes wiring, lights and carpet; use 1 7/8" Hitch Ball (freight included)	82204870	0.5		5075.00
	2001	2000	Orange, equipped w/chrome-plated cast aluminum wheels and tires; made of composite material/aluminum; includes wiring, lights and carpet; use 1 7/8" Hitch Ball (freight included)	82205888	0.5		5075.00
	2001	1997	Red; equipped w/chrome-plated cast aluminum wheels and tires; made of composite material/aluminum; includes wiring, lights and carpet; use 1 7/8" Hitch Ball (freight included)	82204876	0.5		5075.00
	2001	2000	Silver; equipped w/chrome-plated cast aluminum wheels and tires; made of composite material/aluminum; includes wiring, lights and carpet; use 1 7/8" Hitch Ball (freight included)	82205887	0.5		5075.00
	2000	1997	Woodward Edition, equipped w/chrome plated cast aluminum wheels and tires, made of composite material/aluminum, painted two tone black top over a red body. Includes wiring, lights and carpet. Uses a 1 7/8" Hitch Ball (freight included)	82206297	0.5		5075.00

*Wiring must be fed through tongue and bolted to frame.

VENTVISOR®



Ventvisor (shown on Grand Cherokee)



PT Cruiser Ventvisor



Ventvisor (shown on Ram)

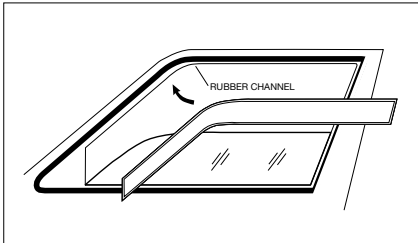

Install easily, acrylic style

MOPAR FEATURES

- Designed not to interfere with outside mirror
- Follow contours of the window lines
- Allow windows to be vented in inclement weather
- Embossed Pentastar, Jeep®, or Ram's Head logo
- Mopar Accessories are covered by either the 3-year/36,000-mile New Vehicle Limited Warranty, or the 12-month/12,000-mile Mopar Basic Limited Warranty, whichever is more favorable to the customer

COMPETITORS?*

- Does it interfere with mirror?
- Jeep, Pentastar and Ram's Head logo are exclusive to DaimlerChrysler, Jeep and Mopar
- Does the warranty compare?

*Check your market for your competitive situation.
Ventvisor is a registered trademark of Auto Ventshade Company.

INSTALLATION:

Installs quickly with adhesive tape

VENTVISOR® (CONT.)

Vehicle Line	MYO	MYI	Application Remarks	Part Number	Instl Time	Group	Sugg Retail Price
VENTVISORS							
Cherokee 2-Door	2001	1986	2-door	82203455	0.2	T	55.00
Cherokee 4-Door	2001	1984	4-door	82203454	0.4	T	69.00
Concorde, LHS, 300M	2001	1998	Tinted, 4-door	82203662	0.2	T	86.00
Dakota Quad Cab	2001	2000	4-door	82204999	0.4	T	86.00
	2001	2000	Tinted, 4-door — over mirror design	82206374	0.4	T	86.00
Dakota Regular & Club Cab	2001	1997	2-door	82202758	0.3	T	55.00
	2001	1997	Tinted, 4-door	82206373	0.3	T	56.00
Durango	2001	1998	4-door	82203672	0.2	T	86.00
	2001	1998	Tinted, 4-door — over mirror design	82206375	0.2	T	86.00
Grand Cherokee	2001	1999	4-door	82204502	0.4	T	86.00
Intrepid	2001	1998	Tinted, 2-door	82203661	0.2	T	86.00
Minivan (All)	2001	2001	Tinted, 2-door	82205924	0.2	T	86.00
	2000	1996	2-door	82300875	0.2	T	54.00
Neon	2001	2000	Tinted	82204552	0.3	T	73.00
PT Cruiser	2001	2001	Tinted, 4-door	82205333	0.2	T	73.00
Ram Pickup (All)	2001	2000	Tinted, 2-door, w/trailer tow — AHC	82206376	0.3	T	55.00
	2001	1994	2-door	82204513	0.3	T	60.00
Sebring Sedan, Stratus Sedan	2001	2001	4-door	82205978	0.2	T	88.00
Wrangler	2001	1997	Tinted, w/hard door models only, 2-door	82202296	0.2	T	55.00
WINDOW PACKAGES							
Ram Pickup (All)	2001	1998	Rear sliding window, deep tint, complete kit	55346644AG	1.5	T	325.00

WHEELS, JEEP®



Silver Star (polished)



Silver Star (painted)



Stratton (polished)



Stratton (painted)

MOPAR FEATURES	COMPETITORS?*
<ul style="list-style-type: none"> Engineered exclusively for Mopar with correct offset, clearance to suspension and brake components One-piece cast and machined to center on hub, which reduces run out and allows repeatable, more accurate balancing Accepts standard wheel weights Polished or painted surfaces with heat-cured acrylic Clear Coat finishes allow for long-lasting good looks and corrosion resistance Accepts existing high-quality production chrome lug nuts Jeep® logo center caps DaimlerChrysler engineering tested for reliability, durability and safety Mopar Accessories are covered by either the 3-year/36,000-mile New Vehicle Limited Warranty, or the 12-month/12,000-mile Mopar Basic Limited Warranty, whichever is more favorable to the customer 	<ul style="list-style-type: none"> “One wheel should fit all” application? Do they rely on lug bolts to center because center pilot is enlarged to fit all applications? Are special weights restricted to one location, limiting accuracy of dynamic balancing? Does it have a heat-cured Clear Coat finish? Or no Clear Coat at all which requires frequent hand polishing? Will they require special, extra-cost lug nuts? No other manufacturer is authorized to use the Jeep logo Only Mopar Accessories are tested by DaimlerChrysler engineering Does the warranty compare?

*Check your market for your competitive situation.

INSTALLATION:

- Fits standard tire mounting machines
- Accepts standard wheel weights
- Mopar locking nuts may be used

Vehicle Line	MYO	MYI	Application Remarks	Part Number	Instl Time	Group	Sugg Retail Price
WHEELS							
Cherokee	2001	1984	15" x 7" Stratton, Painted	82203676	0.4*		113.00
	2001	1984	15" x 7" Stratton, Polished	82202959	0.4*		147.00
Grand Cherokee	2001	1999	17" x 7.5" Polished Cast Aluminum	82205339 [†]	0.4*		215.00
	2001	1999	17" x 7.5" Chrome Plated Cast Aluminum	82205898 [†]	0.4*		275.00
Wrangler	2001	1999	5-spoke 15" x 8" painted cast aluminum wheel	82205102	0.4*		127.00
	2001	1999	5-spoke 15" x 8" polished with Clear Coat	82205101	0.4*		154.00
	2001	1999	5-spoke 15" x 8" wheel, Chrome Plated	82205897	0.4*		245.00
	2001	1987	15" x 7" Silver Star Painted	82203677	0.4*		113.00
	2001	1987	15" x 7" Silver Star Polished	82202958	0.4*		147.00
Wrangler, Cherokee SE	2001	1997	5-spoke 15" x 7" chrome plated steel	82205187 [†]	0.4*		120.00

*Per wheel.

[†] Available 2/1/01.

WHEELS, PASSENGER CAR, MINIVAN & TRUCK



Star Spoke Wheels (Ram Pickup)



16-spoke Neon/
PT Cruiser 15"
Polished/Painted



16"x6" Painted
(PT Cruiser)



16"x6" Chrome-
Plated (PT Cruiser)



APEX Neon Polished/Painted



16"x6.5",
Cast Aluminum
(Minivan)



17"x6.5",
Cast Aluminum
(Minivan)



5-spoke (Ram)
Cast Aluminum/
Polished



RT Style Wheels,
Cast Aluminum
(Dakota Quad Cab)

MOPAR FEATURES

- Engineered exclusively for Mopar
- Tested and approved by DaimlerChrysler Corporation Engineering for fit, performance and reliability on each specific application
- One-piece cast aluminum, designed and machined to center on hub, reducing run-out and allowing accurate balancing with standard weights
- Bright polished and silver painted surfaces both have baked-on acrylic Clear Coat that meets DaimlerChrysler Corporation specifications for long-lasting good looks and corrosion resistance
- Chrome wheels pass a 192-hour OE salt-bath test to ensure a long-lasting sparkle
- Includes PT Cruiser logo center cap, a Mopar exclusive
- One-piece forged aluminum wheels are lighter than cast aluminum or steel wheels and are far stronger
- Mopar locking lug nuts may be used (may affect 3500 center cap retention)
- Accepts standard wheel weights
- Accepts existing high-quality production (OE) chrome lug nuts
- Accepts existing production chrome center caps
- Mopar Accessories are covered by either the 3-year/36,000-mile New Vehicle Limited Warranty or the 12-month/12,000-mile Mopar Basic Limited Warranty, whichever is more favorable to the customer

COMPETITORS?*

- "One wheel should fit all" cast wheel applications?
- Do they depend on less accurate lug bolts to center because center pilot is enlarged to fit all applications?
- Tape-on weights restricted to one location, limiting accuracy of dynamic balancing?
- Requires special, extra-cost, lower-quality chrome lug nuts?
- Requires special, extra-cost, lower-quality nondescript center caps?
- Is it a "one wheel should fit all" application requiring realignment because offset is incorrect?
- It may rely on inaccurate lug bolts to center because center pilot is enlarged to fit "all" applications
- It may require special weights which may limit accuracy of dynamic balancing
- Is there a non-heat-cured Clear Coat or no Clear Coat at all which requires frequent hand polishing of polished wheels?
- Are testing standards the same as Mopar?
- No other manufacturer is authorized to use the Neon or PT Cruiser logo
- Does the warranty, if any, compare?

*Check your market for your competitive situation.

WHEELS, PASSENGER CAR, MINIVAN & TRUCK (CONT.)

Vehicle Line	MY0	MY1	Application Remarks	Part Number	Instl Time	Group	Sugg Retail Price
WHEELS							
Breeze, Cirrus, Stratus	2000	1995	7-spoke JA, 14"x6", painted w/Clear Coat, w/Plymouth logo center cap and 5 chrome lug nuts	82204989	0.4*		113.00
	2000	1995	7-spoke JA, 15"x6", painted w/Clear Coat, w/Chrysler or Dodge logo center cap, use PN 06502738, chrome lug nuts included	82204988	0.4*		113.00
	2000	1995	7-spoke JA, 14"x6", polished	82204406	0.4*		113.00
	2000	1995	7-spoke JA, 15"x6", polished	82204267	0.4*		113.00
Minivan (All)	2001	2001	17 x 6.5, painted silver, w/Dodge Ram/ Chrysler logo, w/bright lug nuts	82206508	0.4*		175.00
	2001	2001	16 x 6.5, painted silver, w/Chrysler/Dodge logo center cap and bright lug nuts	82206504	0.4*		160.00
Dakota (All)/ Durango	2001	1999	17" x 9", cast aluminum painted true silver, w/Clear Coat and Ram logo center caps, use existing lug nuts	82205708	0.4*		160.00
Neon	2001	2000	16-spoke, 15"x6" painted True Silver with Clear Coat. Individual wheel with chrome/black center cap and 5 chrome lug nuts	82204993	0.5*		113.00
	2001	2000	16-spoke, 15" x 6", polished with Clear Coat. Individual wheel with chrome/black center cap and 5 chrome lug nuts	82204991	0.5*		167.00
	2001	2000	Apex, 14" x 6" painted	82203675	0.5*		113.00
	2001	2001	Apex, 14" x 6" polished	82202960	0.5*		113.00
Prowler	2001	1997	Prowler Trailer Wheel - 15" x 6", Chrome Plated	82204708	0.4*		260.00
PT Cruiser	2001	2001	16-spoke, 15" x 6" Painted w/Clear Coat	82205583	0.4*		135.00
	2001	2001	5-spoke, 16" x 6" - Painted w/Clear Coat	82205584	0.4*		150.00
	2001	2001	5-spoke, 16" x 6", Polished w/Clear Coat and PT Cruiser logo center cap	82205582	0.4*		180.00
	2001	2001	16-spoke, 15" x 6", w/Clear Coat and PT Cruiser logo center cap, lace style	82205581	0.4*		195.00
	2001	2001	5-spoke, 16" x 6" chrome plated, w/ PT Cruiser Center Cap	82205896	0.4*		200.00
Ram 1500 Regular Cab	2001	1999	5-spoke, 16" x 7", cast aluminum painted silver, w/Clear Coat and Ram logo center caps	82205355	0.4*		136.00
	2001	1999	5-spoke, 16" x 7", cast aluminum polished, w/Clear Coat and Ram logo center caps	82205353	0.4*		160.00
	2001	1994	STAR SPOKE front— 16" x 7" polished w/Clear Coat, individual wheel w/chrome valve stem, use OE Ram chrome center cap and chrome lug nuts	82202872	0.4*		196.00
Ram 3500 Regular Cab	2001	1994	STAR SPOKE rear — 16" x 6" polished w/Clear Coat, individual wheel w/chrome valve stem, use existing OE Ram chrome center cap and vehicle lug nuts	82202874	0.4*		205.00
	2001	1994	STAR SPOKE — 16" x 6" polished w/Clear Coat, individual wheel w/chrome valve stem, use existing OE Ram chrome center cap and vehicle lug nuts	82202875	0.4*		205.00
Sebring Sedan & Conv., Stratus Sedan	2001	2001	5-spoke, 16" x 6", w/ individual wheel with Dodge and Chrysler logo center cap, use existing lug nuts. Chrome Plated	82206783 [†]	0.4*		240.00
	2001	2001	5-spoke, 16" x 6" polished w/ Clear Coat, individual wheel w/ Dodge and Chrysler logo center cap, use existing vehicle lug nuts	82206782 [†]	0.4*		175.00

*Per wheel.

[†] Available 2/1/00.

WHEEL FLARES



Wheel Flare, front (shown on Ram Pickup)

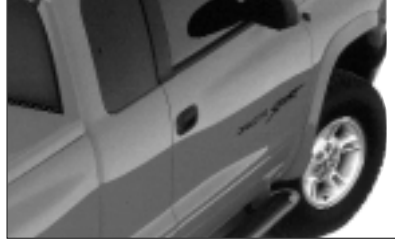

Wheel Flare, front (shown on Dakota)



Wheel Flare, rear (shown on Dakota)

MOPAR FEATURES	COMPETITORS?*
<ul style="list-style-type: none"> • Molded to the contours of the vehicle, custom fit to body panel • Unique design minimizes road spray on vehicle • Thermoplastic material provides outstanding toughness and flexibility • OEM-approved paint system for durability and color match • Mopar Accessories are covered by either the 3-year/36,000-mile New Vehicle Limited Warranty or the 12-month/12,000-mile Mopar Basic Limited Warranty, whichever is more favorable to the customer 	<ul style="list-style-type: none"> • Do they have a universal design? • Is construction more rigid, allowing for easier cracking? • Will paint match exactly? Is the finish durable? • Does the warranty compare?

*Check your market for your competitive situation.

INSTALLATION:

- Predrilled molding provides for easier alignment and quicker installation
- Some drilling required
- Same as original equipment big tire flares on Dakota

WHEEL FLARES (CONT.)

Vehicle Line	MY0	MY1	Application Remarks	Part Number	Instl Time	Group	Sugg Retail Price
WHEEL FLARES — SET OF FOUR							
Dakota Quad Cab	2000	2000	Light Driftwood (PFA)	82205258	0.8	T	255.00
	2000	2000	Solar Yellow (PYH)	82205261	0.8	T	255.00
	2001	2000	Amber Fire (PV3)	82205251	0.8	T	260.00
	2001	2000	Black (PX8)	82205252	0.8	T	260.00
	2001	2000	Bright White (PW7)	82205253	0.8	T	260.00
	2001	2000	Dark Garnet Red (PRV)	82205254	0.8	T	260.00
	2001	2000	Flame Red (PR4)	82205255	0.8	T	260.00
	2001	2000	Forest Green (PG8)	82205256	0.8	T	260.00
	2001	2000	Intense Blue (PB3)	82205257	0.8	T	260.00
	2001	2000	Medium Bronze (PTL)	82205260	0.8	T	260.00
	2001	2000	Patriot Blue (PBT)	82205259	0.8	T	260.00
	Dakota Regular & Club Cab	2000	1997	Deep Amethyst (PCU)	82204181	0.8	T
2000		1997	Light Driftwood (PFA)	82202877	0.8	T	255.00
2000		1997	Metallic Red (PRF)	82202882	0.8	T	255.00
2000		1997	Solar Yellow (PYH)	82205100	0.8	T	255.00
2001		2000	Amber Fire (PV3)	82205806	0.8	T	260.00
2001		1997	Black (PX8)	82202884	0.8	T	260.00
2001		1997	Bright White (PW7)	82202885	0.8	T	260.00
2001		2000	Dark Garnet Red (PRV)	82205807	0.8	T	260.00
2001		1997	Flame Red (PR4)	82202883	0.8	T	260.00
2001		1997	Forest Green (PG8)	82204179	0.8	T	260.00
2001		1997	Intense Blue (PB3)	82204180	0.8	T	260.00
2001		2000	Medium Bronze (PTL)	82205809	0.8	T	260.00
2001		2000	Patriot Blue (PBT)	82205808	0.8	T	260.00
Durango	2000	1998	Light Driftwood (PFA)	82204185	0.8	T	275.00
	2000	2000	Aquamarine (PQW)	82205804	0.8	T	280.00
	2001	1998	Black (PX8)	82204182	0.8	T	280.00
	2001	1998	Bright Platinum (PS4)	82205097	0.8	T	280.00
	2001	1998	Bright White (PW7)	82204183	0.8	T	280.00
	2001	1998	Chili Pepper Red (PEA)	82204190	0.8	T	280.00
	2001	1998	Flame Red (PR4)	82204184	0.8	T	280.00
	2001	1998	Forest Green (PG8)	82204186	0.8	T	280.00
	2001	2000	Medium Bronze (PTL)	82205805	0.8	T	280.00
	2001	1998	Patriot Blue (PBT)	82205096	0.8	T	280.00
Ram Pickup (All)	2001	1994	Molded Black, can be painted	82204939	1.0	T	460.00
	2000	1994	Light Driftwood (PFA)	82205338	1.0	T	525.00
	2000	1994	Solar Yellow (PYH)	82204934	1.0	T	525.00
	2001	1994	Black (PX8)	82204933	1.0	T	550.00
	2001	1994	Bright White (PW7)	82204931	1.0	T	550.00
	2001	1994	Flame Red (PR4)	82204932	1.0	T	550.00
	2001	1994	Forest Green (PG8)	82204937	1.0	T	550.00
	2001	1994	Intense Blue (PB3)	82204938	1.0	T	550.00

WHEEL LOCKS

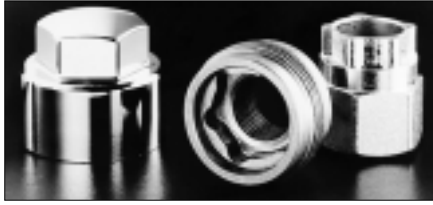

Two-Piece Wheel Lock Set



One-Piece Wheel Lock Set

MOPAR FEATURES

- Exclusive Mopar key codes help ensure maximum protection and serviceability, sold only through DaimlerChrysler Motors Corporation dealers; protect against wheel and tire theft
- Available in one- and two-piece styles, for both steel and aluminum wheels
- Two-piece style includes caps
- Bright chrome plastic cap included with two-piece set to give original equipment look
- Mopar keys interlock in pattern for easier removal
- Lightweight design does not affect wheel balance
- Mopar Accessories are covered by either the 3-year/36,000-mile New Vehicle Limited Warranty, or the 12-month/12,000-mile Mopar Basic Limited Warranty, whichever is more favorable to the customer

COMPETITORS?*

- Are key patterns universal to aftermarket?
- Do they include caps in kit for appearance and lock protection?
- Do they have keys that easily strip off from the lock?
- Will the wheels have to be rebalanced?
- Does the warranty compare?

*Check your market for your competitive situation.

INSTALLATION:

- No wheel rebalancing is necessary
- Toll-free lock replacement hot line: (800) 669-8788
- Set includes four locking nuts, one key, lug wrench key holder, and four caps for two-piece sets
- Special key holder included for attachment to lug wrench

WHEEL LOCKS (CONT.)

Vehicle Line	MYO	MYI	Application Remarks	Part Number	Instl Time	Group	Sugg Retail Price
WHEEL LOCK SETS							
Avenger, Sebring Coupe, Breeze, Cirrus, Stratus, Sebring Conv., Concorde, Intrepid, LHS, 300M, Neon, PT Cruiser	2001	1993	1-piece chrome-plated Lock Set, includes 4 locking nuts and exclusive Mopar key patterns	82300160	D.I.Y.	T	30.00
Avenger, Sebring Coupe, Breeze, Cirrus, Stratus, Sebring Sedan & Conv., Stratus Sedan, Sebring Conv., Concorde, Intrepid, LHS, 300M, Neon, PT Cruiser, Sebring Coupe, Stratus Coupe	2001	1993	2-piece Lock Set, includes 4 locking nuts, 4 chrome plastic caps and exclusive Mopar key patterns	04504841	D.I.Y.	T	30.00
Avenger, Sebring Coupe, Prowler	2001	1995	2-piece chrome-plated Lock set, includes 4 locking nuts and exclusive Mopar key patterns	05247022	D.I.Y.	T	32.00
Cherokee	2001	1989	2-piece Lock set, Alloy Wheels Only, exclusive Mopar key patterns	04504840	D.I.Y.	T	32.00
Cherokee, Wrangler	2001	1990	1-piece chrome plated lock set, 4 in a set, Exclusive Mopar Key Patterns	82201771	D.I.Y.	T	15.50
	2001	1984	1-piece chrome-plated Lock Set, includes 4 locking nuts, only available on alloy or steel wheels for Dodge and Jeep vehicles, not available for 8-lug and chrome-plated steel wheels on Dodge Ram Pickup, exclusive Mopar key patterns	82201649	D.I.Y.	T	32.00
	2001	1984	1-piece chrome-plated Lock Set for Dodge and Jeep vehicles, includes 5 locking nuts; fifth lock is for Jeep vehicles w/ exterior mounted spare, not available for 8-lug and chrome-plated steel wheels on Dodge Ram Pickup), exclusive Mopar key patterns	82201650	D.I.Y.	T	39.00
Dakota (All)	2001	1998	1-piece chrome-plated Lock Set, includes 4 locking nuts, alloy wheels only, exclusive Mopar key patterns	82204735	D.I.Y.	T	38.00
Grand Cherokee	2001	1999	1-piece chrome-plated Lock Set, includes 4 locking nuts, alloy wheels only, exclusive Mopar key patterns	82204735	D.I.Y.	T	38.00
Minivan (All)	2001	2001	1-piece chrome-plated Lock Set, includes 4 locking nuts and exclusive Mopar key patterns	82300160	D.I.Y.	T	30.00
	2001	1996	2-piece Lock Set, includes 4 locking nuts, 4 chrome plastic caps and exclusive Mopar key patterns	04504841	D.I.Y.	T	30.00
Ram Pickup (All)	2001	1994	1-piece chrome-plated Lock Set, includes 4 locking nuts, only available on alloy or steel wheels for Dodge and Jeep vehicles, not available for 8-lug and chrome-plated steel wheels on Dodge Ram Pickup, exclusive Mopar key patterns	82201649	D.I.Y.	T	32.00
	2001	1994	1-piece chrome-plated Lock Set, set of 4 Wheel Locks for 8-lug wheels, exclusive Mopar key patterns	82401333	D.I.Y.	T	32.00

WHEEL LOCKS (CONT.)

Vehicle Line	MYO	MYI	Application Remarks	Part Number	Instl Time	Group	Sugg Retail Price
WHEEL LOCK SETS (CONT.)							
Ram Pickup - Regular Cab (All)	2001	1994	1-piece chrome-plated Lock Set for Dodge and Jeep vehicles, includes 5 locking nuts; fifth lock is for Jeep vehicles w/ exterior mounted spare, not available for 8-lug and chrome-plated steel wheels on Dodge Ram Pickup), exclusive Mopar key patterns	82201650	D.I.Y.	T	39.00
Ram Pickup - Regular Cab (All), Durango	2001	1994	2-piece Lock Set, for Alloy Wheels Only, exclusive Mopar key patterns	04504840	D.I.Y.	T	32.00
Ram Van/Wagon, Dakota (All)	2001	1989	2-piece Lock Set, for Alloy Wheels Only, exclusive Mopar key patterns	04504840	D.I.Y.	T	32.00
Viper	2001	1992	2-piece Lock Set, for Alloy Wheels Only, exclusive Mopar key patterns	04504840	D.I.Y.	T	32.00

WHEEL TRIM RINGS



Dually Wheel Liner

MOPAR FEATURES	COMPETITORS?*
<ul style="list-style-type: none"> • Same as original equipment • Made of custom stainless steel for Dodge Ram Pickup with dual-rear wheels • Mopar Accessories are covered by either the 3-year/36,000-mile New Vehicle Limited Warranty or the 12-month/12,000-mile Mopar Basic Limited Warranty, whichever is more favorable to the customer 	<ul style="list-style-type: none"> • Do they meet Dodge's tough original equipment parts standards? • Does it compare?

*Check your market for your competitive situation.

INSTALLATION:

- Easily installed
- Same as original equipment
- Packaged in sets of four
- Kit includes four of each of the following: rim wheel covers, center retaining rims and center cap/nut covers

Vehicle Line	MY0	MY1	Application Remarks	Part Number	Instl Time	Group	Sugg Retail Price
WHEEL TRIM RINGS							
Ram Pickup	2000	1994	Dually Wheel Liner made of custom stainless steel	82401194	0.8*1		245.00

*Per wheel.

1 3500 model with dual-rear wheels.

WINCHES, JEEP®



Ramsey Winch (shown on Cherokee)

FEATURES:

- Four fully integrated solenoids — two operating solenoids; two backup solenoids
- This product has been designed to meet Federal Motor Vehicle Safety Standards for occupant protection and vehicle lighting
- Design does not adversely affect airflow to the engine compartment or impede operation of the hood
- Platinum 9000H currently boasts the fastest-rated line speed at 84 inches/minute

SPECIFICATIONS:

Ramsey Platinum 9000H Winch:

- Rated line pull (single line): 9,000 lb
- Gear Reduction ratio: 138:1
- Motor: Series wound — 4.8 hp (12V) DC
- Drum size: diameter 2.5", length 9"
- Cable length: 150' of $\frac{5}{16}$ " galvanized aircraft cable with clevis hook and hawse fairlead

Pro Plus 8000H and Pro Plus 8000HX Ramsey Winch:

- Rated line pull (single line): 8,000 lb
- Gear Reduction ratio: 126:1
- Motor: Series wound — 4.8 hp (12V) DC
- Drum size: diameter 2.5", length 9" with hawse fairlead

Choose from 2 models:

— Pro Plus 8000H model with 95' of $\frac{5}{16}$ " galvanized aircraft cable and clevis hook

— Pro Plus 8000HX model with 150' of $\frac{5}{16}$ " galvanized aircraft cable and clevis hook

Pro Plus 6000H Ramsey Winch:

- Rated line pull (single line): 6,000 lb
- Gear Reduction ratio: 90:1



Ramsey Winch, Tube Bumper (shown on Wrangler)



ProPlus 900H



ProPlus 800H



ProPlus 600H



Jeep vehicle-engineered mounting plate



MD8000



Warn Winch with Grille Bumper Guard (shown on Wrangler)



XD9000i

- Motor: Series wound — 4.8 hp (12V) DC
- Diameter: 2.5", length 9"
- Cable length: 100' of $\frac{1}{4}$ " galvanized aircraft cable with clevis hook and hawse fairlead

Ramsey Winch:

- 6,000-, 8,000- and 9,000-pound rated pull line for heavy-duty applications
- 230- to 400-amp draw at full-rated load
- Weather-shielded solenoids; cam action clutch disengages planetary gear stages for free spooling
- Strong, reliable, automatic load-holding brake
- Electric reversible motor; three-stage planetary gear system
- Black powder-coat finish
- 2.1 hp, 210:1 gear ratio (Pro 6000, Pro 8000), 138:1 gear ratio (Pro 9000), free-spooling clutch, weighs 95 pounds, remote control

Warn Winch:

- 9,000-pound rated pull line for heavy-duty applications
- 230- to 280-amp draw at full-rated load
- Weather-shielded solenoids; cam action clutch disengages planetary gear stages for free spooling
- Strong, reliable, automatic load-holding brake

- Electric reversible motor; three-stage planetary gear system
- Black powder-coat finish

SPECIFICATIONS:

- 4.8 hp, 216:1 gear ratio, free spooling clutch, 100' of $\frac{5}{16}$ " wire rope, weighs 74 lbs, remote control (Wrangler)

INSTALLATION:

- Custom Grille Guard Mounting System for Cherokee
- Bolts to vehicle frame
- Some drilling may be required for solenoid assembly
- Utilizes bumper mounting holes
- Can be used with some Mopar Grille Guards

INSTALLATION TIME:

- 1.5 hours (Wrangler)
- 2.0 hours (Cherokee)

WINCHES, TRUCK



Warn Winch and Mounting Kit (shown on Ram Pickup)



Mopar/Ramsey Mounting Kit



Ramsey ProPlus 9000H with Mopar Mounting Kit



Winch Accessory Package



Warn Winch XD9000i



Warn Winch with Mopar Mounting Kit (shown on Dakota)



Ramsey Winch with Mopar Mounting Kit (shown on Durango)

FEATURES:

- Four fully integrated solenoids — two operating solenoids; two back-up solenoids
- This product has been designed to meet Federal Motor Vehicle Safety Standards for occupant protection and vehicle lighting
- Design does not adversely affect airflow to the engine compartment or impede operation of the hood
- Platinum 9000H currently boasts the fastest rated line speed at 84 inches/minute

SPECIFICATIONS:

Ramsey Platinum 9000H Winch:

- Rated line pull (single line): 9,000-lb
- Gear Reduction ratio: 138:1
- Motor: Series wound — 4.8-hp (12V) DC
- Drum size dm 2.5", length 9.0"
- Cable length 150' of $\frac{5}{16}$ " galvanized aircraft cable with clevis hook and hawse fairlead

ProPlus 8000H & ProPlus 8000HX Ramsey Winch:

- Rated line pull (single line): 8,000-lb
- Gear Reduction ratio: 126:1
- Motor: Series wound — 4.8-hp (12V) DC
- Drum size dm 2.5", length 9.0" with hawse fairlead

Choose from 2 models:

- ProPlus 8000H model with 95' $\frac{5}{16}$ " galvanized aircraft cable with clevis hook
- ProPlus 8000HX model with 150' $\frac{5}{16}$ " galvanized aircraft cable with clevis hook

ProPlus 6000H Ramsey Winch:

- Rated line pull (single line): 6,000-lb
- Gear Reduction ratio: 90:1
- Motor: Series wound — 4.8-hp (12V)
- Drum size dm 2.5", length 9.0"
- Cable length 100', $\frac{1}{4}$ " galvanized aircraft cable with clevis hook and hawse fairlead

Warn Winch:

- 9,000-lb rated line pull for heavy-duty applications (Dakota/Durango)
- 460-amp draw at full-rated load (Dakota/Durango)
- 9,000-lb single pulling capacity for high-performance heavy-duty applications
- Solenoid integrated into metal housing is an advanced new look in Winches
- Weather-shielded solenoids; cam action clutch disengages planetary gear stages for free spooling
- Strong, reliable, automatic load-holding brake
- Heavy-duty series wound power motor; electric reversible motor, three-stage planetary gear system
- Black powder-coat finish with anodized aluminum crossbar

SPECIFICATIONS:

- 4.6-hp, 156:1 gear ratio, free spooling clutch, 125' of $\frac{5}{16}$ " wire rope, weighs 82.5 lbs, remote control (Dakota/Durango)
- 4.6-hp, 156:1 gear ratio, free spooling clutch, 100' of $\frac{5}{16}$ " wire rope, weighs 78 lbs, remote control (Ram)

INSTALLATION:

- Custom Grille Guard Mounting System
- Bolts to existing frame
- Cannot be used with Mopar Grille Guards (Warn)
- 4WD Durangos only

NOTE: Heavy-duty alternator, battery, springs and shock absorbers recommended for Winch installation. Check Owner's Manual for installation requirements.

WINCHES

Vehicle Line	MYO	MYI	Application Remarks	Part Number	Instl Time	Group	Sugg Retail Price
WINCHES*							
Dakota 4x4	2001	1988	Ramsey ProPlus 6000H-lb, w/hawse fairlead and 95 feet of cable	82206402	1.5	T	865.00
	2001	1988	Ramsey ProPlus 8000H-lb, w/hawse fairlead and 95 feet of cable	82206403	1.5	T	960.00
	2001	1991	Ramsey ProPlus 8000HX-lb, w/hawse fairlead and 50 feet of cable	82206404	1.5		1010.00
	2001	1994	Ramsey Pro 9000H, w/hawse fairlead and 150 feet of cable	82206401	1.5	T	1000.00
	2001	1997	Warn XD9000i w/hawse fairlead and 125 feet of cable	82202612	1.5	T	1250.00
Durango 4x4, Ram Pickup 4x4	2001	1994	Ramsey ProPlus 6000H-lb, w/hawse fairlead and 95 feet of cable	82206402	1.5	T	865.00
	2001	1994	Ramsey ProPlus 8000H-lb, w/hawse fairlead and 95 feet of cable	82206403	1.5	T	960.00
	2001	1994	Ramsey ProPlus 8000HX-lb, w/hawse fairlead and 50 feet of cable	82206404	1.5		1010.00
	2001	1994	Ramsey Pro 9000H, w/hawse fairlead and 150 feet of cable	82206401	1.5	T	1000.00
	2001	1997	Warn XD9000i w/hawse fairlead and 125 feet of cable	82202612	1.5	T	1250.00
Ram Pickup 4x4	2001	1994	Warn XD9000i Winch features an automatic brake, a 3-stage planetary gearset with a 156:1 gear ratio, a Roller Fairlead and 125 feet of 5/16 inch steel cable	82401113	1.0	T	1100.00
	2001	1997	Warn XD9000i w/hawse fairlead and 125 feet of cable	82202612	1.5	T	1250.00
Wrangler	2001	1997	Warn M 8000, w/hawse fairlead and 100 foot cable	82202191	1.0	T	920.00
	2001	1994	Ramsey Pro 9000H, w/hawse fairlead and 150 feet of cable	82206401	1.5	T	1000.00
	2001	1997	Warn XD9000i w/hawse fairlead and 125 feet of cable	82202612	1.5	T	1250.00
	2001	1997	Winch Accessory Kit, w/snatch block, tree trunk protector, shackles and chain, leather gloves and nylon storage bag	82202584	D.I.Y.	T	275.00
Wrangler, Cherokee 4WD	2001	1984	Ramsey ProPlus 6000H-lb, w/hawse fairlead and 95 feet of cable	82206402	1.5	T	865.00
Cherokee 4WD	2001	1985	Ramsey ProPlus 8000H-lb, w/hawse fairlead and 95 feet of cable	82206403	1.5	T	960.00
	2001	1991	Ramsey ProPlus 8000HX-lb, w/hawse fairlead and 50 feet of cable	82206404	1.5		1010.00
	2001	1984	Ramsey Pro 9000H, w/hawse fairlead and 150 feet of cable	82206401	1.5	T	1000.00
	2001	1997	Warn XD9000i w/hawse fairlead and 125 feet of cable	82202612	1.5	T	1250.00

*NOTE: Trailer Tow Package recommended for winch installation. Provides heavy-duty battery, alternator, shocks and springs recommended to support winch.

WINCHES, MOUNTING KITS

MOPAR	COMPETITORS?*
<ul style="list-style-type: none"> Ramsey and Warn Winches are designed to meet Federal Motor Vehicle Safety Standards for occupant protection and vehicle lighting Mopar Accessories are covered by either the 3-year/36,000-mile New Vehicle Limited Warranty or the 12-month/12,000-mile Mopar Basic Limited Warranty, whichever is more favorable to the customer 	<ul style="list-style-type: none"> Have the mounting systems been designed to meet government standards for occupant protection and lighting requirements? Other competitive-make winches may fit Durango or Jeep, but DaimlerChrysler has not evaluated their effect on the vehicle Does the warranty compare?

*Check your market for your competitive situation.

Vehicle Line	MYO	MYI	Application Remarks	Part Number	Instl Time	Group	Sugg Retail Price
WINCHES — MOUNTING KITS*							
Cherokee	2001	1997	Ramsey Mounting Kit, w/Grille Guard	82202905	2.0	T	460.00
Dakota 4x4	2001	1997	Winch Mount and Grille Guard for mounting a Ramsey Winch	82202762	1.5	T	275.00
	2001	1997	Winch Mount and Grille Guard for mounting a Warn Winch	82202763	1.4	T	585.00
Durango 4x4	2001	1998	Winch Mount and Grille Guard for mounting a Ramsey Winch	82202762	1.5	T	275.00
	2001	1998	Winch Mount and Grille Guard for mounting a Warn Winch	82202763	1.4	T	585.00
Ram Pickup 4x4	2001	1994	Combination Winch Mount and Grille Guard for mounting a Ramsey Winch	82204499	1.4	T	595.00
Wrangler	2001	1997	Ramsey Wiring Kit, required if Mounting Kit is used on Mopar Tubular Bumper	82205306	0.2	T	43.00
	2001	1997	Warn Grille Guard, requires Warn Mounting Kit, use w/OE Bumper only	82204135	0.5	T	84.50
	2001	1997	Ramsey Mounting Kit, use w/OE Bumper or Mopar Tubular Bumper	82204132	1.0	T	150.00
	2001	1997	Ramsey Grille Guard, requires Ramsey Mounting Kit, use w/OE Bumper only	82204133	0.2	T	185.00
	2001	1997	Warn Mounting Kit, use w/OE bumper or Mopar Tubular Bumper	82204128	1.0	T	191.00

*NOTE: Trailer Tow Package recommended for winch installation. Provides heavy-duty battery, alternator, shocks and springs recommended to support winch.

WINDSCREEN, CONVERTIBLE



MOPAR FEATURES	COMPETITORS?*
<ul style="list-style-type: none"> • Custom-fit • Sturdy black aluminum frame with mesh falonc • Reduces wind buffeting for front-seat passengers • Easily removable for rear seat access • Includes its own storage bag • Mopar Accessories are covered by either the 3-year/36,000-mile New Vehicle Limited Warranty, or the 12-month/12,000-mile Mopar Basic Limited Warranty, whichever is more favorable to the customer 	<ul style="list-style-type: none"> • Is it custom-fit? • Is it made from sturdy black aluminum? • Does it reduce wind buffeting for front-seat passengers? • Does it remove easily? • Does it include its own storage bag? • Does the warranty compare?

*Check your market for your competitive situation.

INSTALLATION:

- Easily installed

Vehicle Line	MYO	MYI	Application Remarks	Part Number	Instl Time	Group	Sugg Retail Price
WINDSCREEN, CONVERTIBLE							
Sebring Convertible	2001	2001	Windscreen, use with Boot Cover, w/storage bag, removable	82206412	1.0		215.00